

2SK686

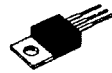

2052A

N-Channel MOS
Silicon Field-Effect Transistor

T-39-11

High Speed Power Switching Applications

Features

Low-on resistance, very high-speed switching, converters

Absolute Maximum Ratings at Ta=25°C

			unit
Drain to Source Voltage	V _{DS}	60	V
Gate to Source Voltage	V _{GS}	±20	V
Drain Current(DC)	I _D	5	A
Peak Drain Current(Pulse)	I _{D peak}	10	A
Allowable Power Dissipation	P _D	40	W
Junction Temperature	T _J	150	°C
Storage Temperature	T _{stg}	-55 to +150	°C

T_C=25°C

Electrical Characteristics at Ta=25°C

			min	typ	max	unit
D-S Breakdown Voltage	V _{DSS}	I _D =1mA, V _{GS} =0	60			V
Drain Current	I _{DSS}	V _{DS} =60V, V _{GS} =0			100	uA
G-S Leakage Current	I _{GSS}	V _{GS} =±20V, V _{DS} =0			±100	nA
Cutoff Voltage	V _{GS(off)}	V _{DS} =10V, I _D =1mA	1.5		4.0	V
Forward Transfer Admittance	Y _{fs}	V _{DS} =10V, I _D =2.5A	1.4	2.0		S
Saturation Resistance	r _{DS(on)}	I _D =2.5A, V _{GS} =10V		0.2	0.3	ohm
Input Capacitance	c _{iss}	V _{DS} =20V, f=1MHz		350		pF
Output Capacitance	c _{oss}	V _{DS} =20V, f=1MHz		230		pF
Reverse Transfer Capacitance	c _{rss}	V _{DS} =20V, f=1MHz		85		pF
Turn-on Time	t _{on}	I _D =2A, V _{GS} =10V		35		ns
Turn-off Time	t _{off}	I _D =2A, V _{GS} =10V		55		ns

Note: Be careful in handling the 2SK686 because it has no protect diode between gate and source.

Switching Time Test Circuit

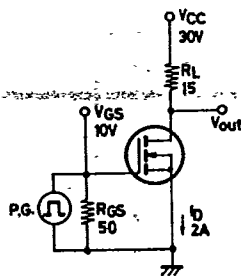

Case Outline 2052A (unit:mm)

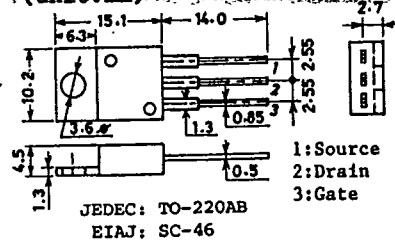

3267TA, TS No.2463-1/2

1783

2SK686

T-39-11

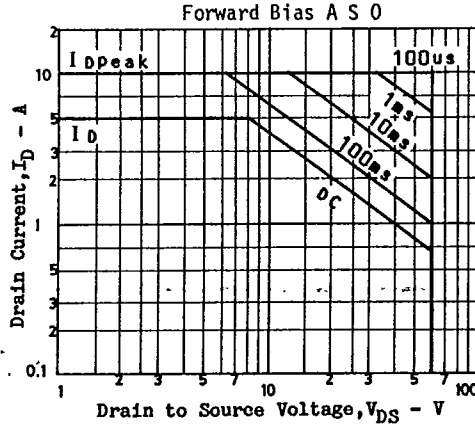
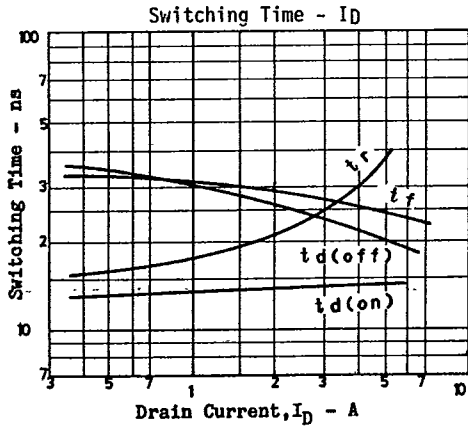
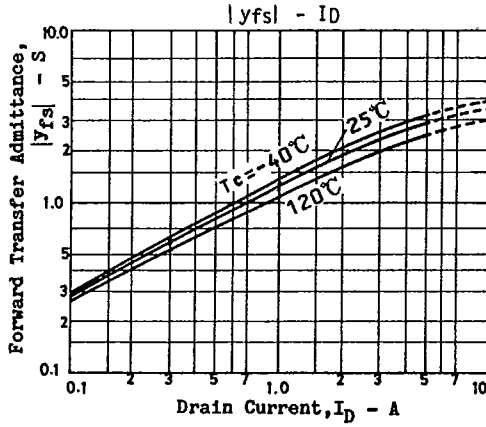
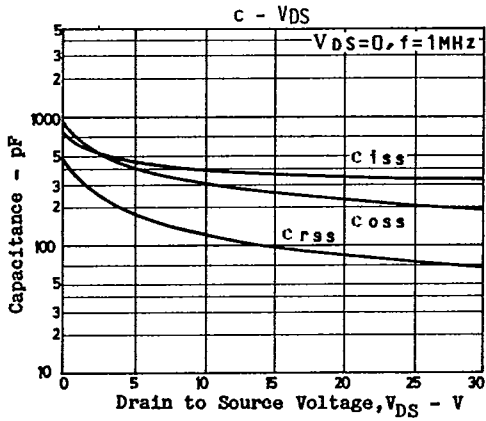
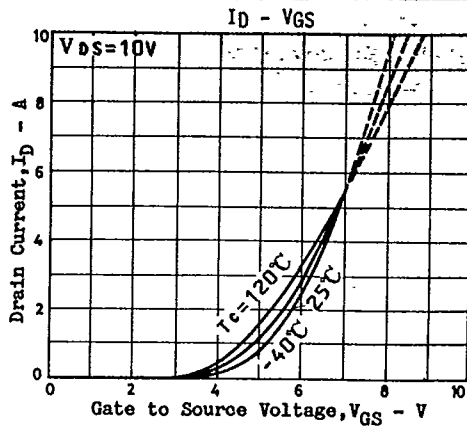
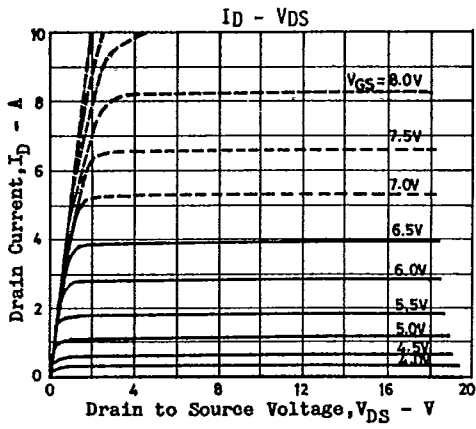

T-91-20

CASE OUTLINES AND ATTACHMENTS

- All of Sanyo Transistor case outlines are illustrated below.
- All dimensions are in mm, and dimensions which are not followed by min. or max. are represented by typical values.
- No marking is indicated.

Case Outline-[2003A]
unit:mm

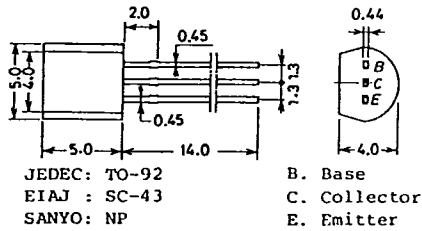

Case Outline-[2009A]
unit:mm

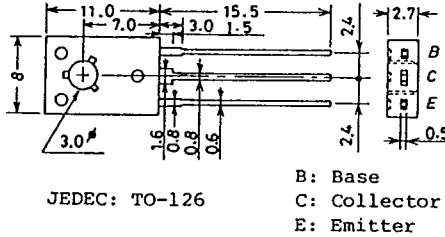

Case Outline-[2004A]
unit:mm

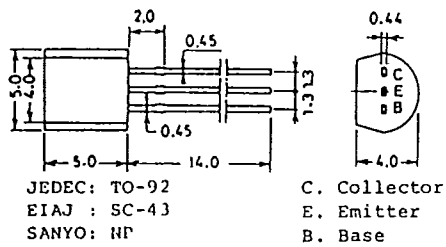

Case Outline-[2010A]
unit:mm

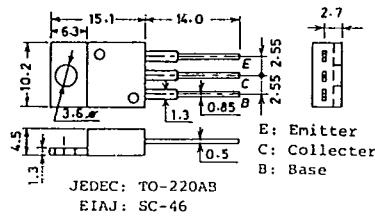

Case Outline-[2005A]
unit:mm

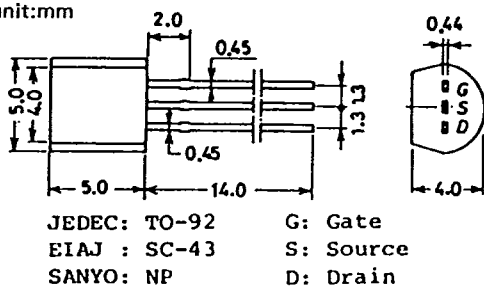

Case Outline-[2012]
unit:mm

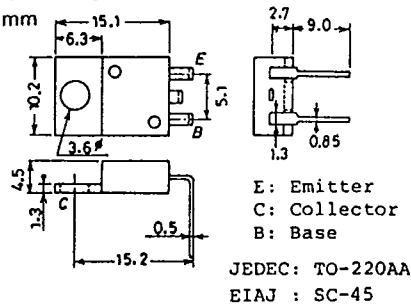

Case Outline-[2006A]
unit:mm

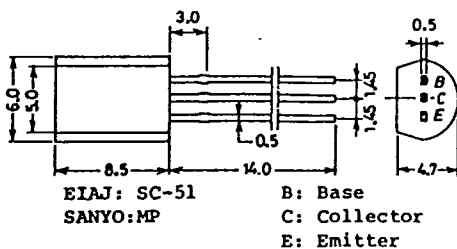

Case Outline-[2013]
unit:mm

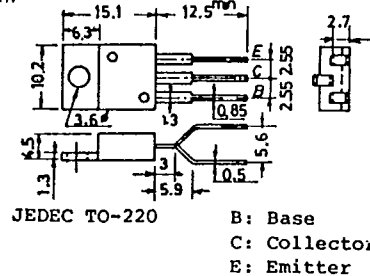

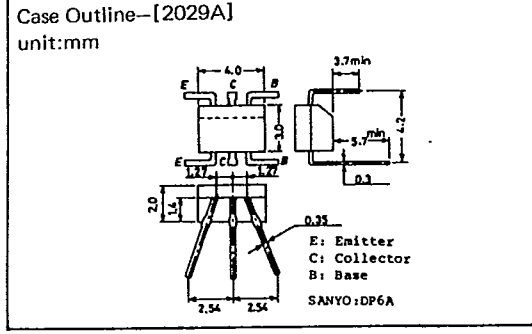
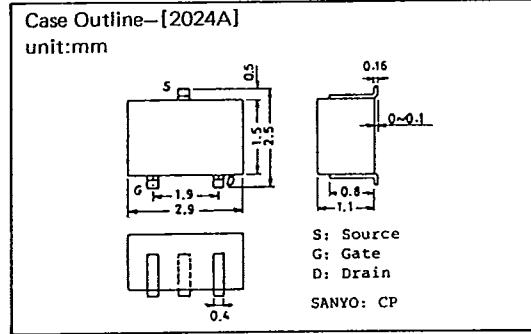
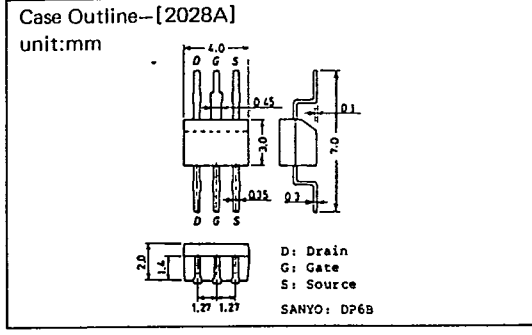
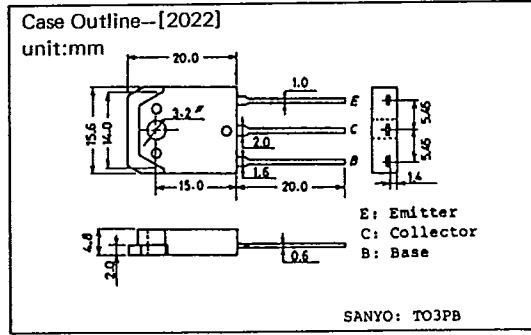
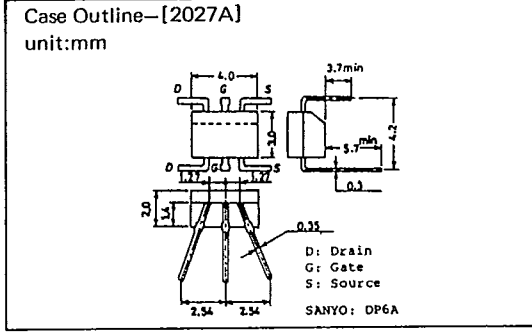
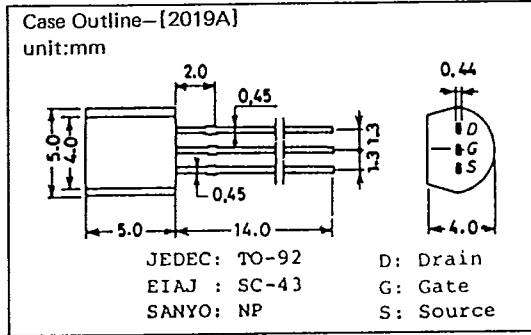
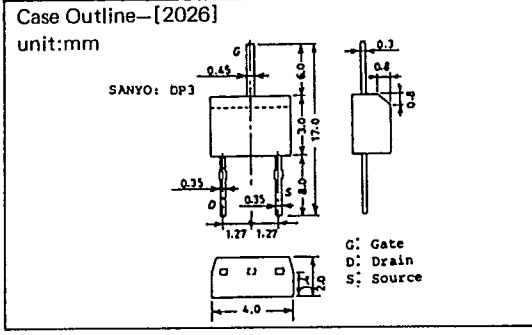
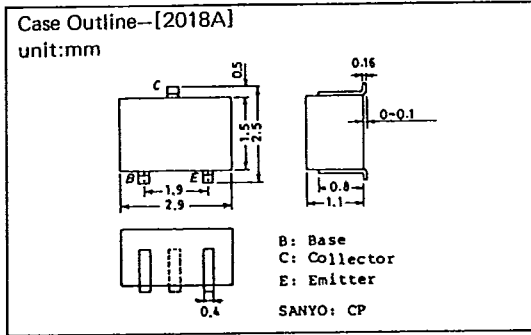
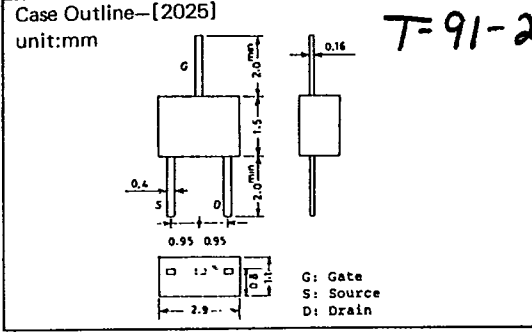
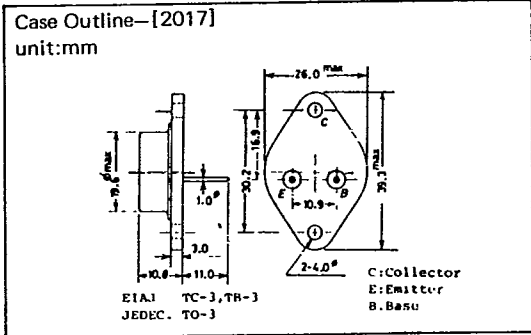

T-91-20

