

MGP15N35CL, MGB15N35CL, MGC15N35CL

Internally Clamped N-Channel IGBT

This Logic Level Insulated Gate Bipolar Transistor (IGBT) features monolithic circuitry integrating ESD and Over-Voltage clamped protection for use in inductive coil drivers applications. Primary uses include Ignition, Direct Fuel Injection, or wherever high voltage and high current switching is required.

- Gate-Emitter ESD Protection
- Temperature Compensated Gate-Collector Voltage Clamp Limits Stress Applied to Load
- Integrated ESD Diode Protection
- Low Threshold Voltage to Interface Power Loads to Logic or Microprocessor Devices
- Low Saturation Voltage
- High Pulsed Current Capability
- Optional Gate Resistor (R_G)

MAXIMUM RATINGS ($T_J = 25^\circ\text{C}$ unless otherwise noted)

Rating	Symbol	Value	Unit
Collector-Emitter Voltage	V_{CES}	380	V_{DC}
Collector-Gate Voltage	V_{CER}	380	V_{DC}
Gate-Emitter Voltage	V_{GE}	22	V_{DC}
Collector Current-Continuous @ $T_C = 25^\circ\text{C}$	I_C	15	A_{DC}
Total Power Dissipation @ $T_C = 25^\circ\text{C}$ Derate above 25°C	P_D	136	Watts
		1.0	$W/^\circ\text{C}$
Operating and Storage Temperature Range	T_J, T_{stg}	-55 to 175	$^\circ\text{C}$



ON Semiconductor

<http://onsemi.com>

N-CHANNEL IGBT
15 A, 350 V
 $V_{CE(on)} = 1.8 \text{ V MAX}$

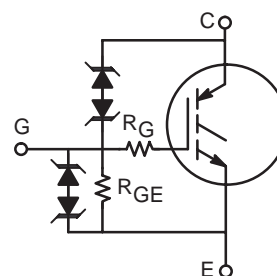

MARKING DIAGRAMS

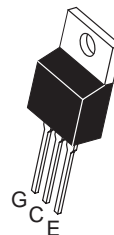

TO-220
CASE 221A
STYLE 9

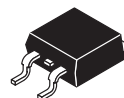

D2PAK
CASE 418B
STYLE 3



A = Assembly Location
WL, L = Wafer Lot
YY, Y = Year
WW, W = Work Week

ORDERING INFORMATION

Device	Package	Shipping
MGP15N35CL	TO-220	50 Units/Rail
MGB15N35CLT4	D2PAK	800 Tape & Reel
MGC15N35CL	Die Options	Not Applicable

MGP15N35CL, MGB15N35CL, MGC15N35CL

UNCLAMPED DRAIN-TO-SOURCE AVALANCHE CHARACTERISTICS ($T_J < 150^\circ\text{C}$)

Characteristic	Symbol	Value	Unit
Single Pulse Collector-to-Emitter Avalanche Energy $V_{CC} = 50\text{ V}$, $V_{GE} = 5\text{ V}$, Pk $I_L = 14.2\text{ A}$, $L = 3\text{ mH}$, Starting $T_J = 25^\circ\text{C}$ $V_{CC} = 50\text{ V}$, $V_{GE} = 5\text{ V}$, Pk $I_L = 10\text{ A}$, $L = 3\text{ mH}$, Starting $T_J = 150^\circ\text{C}$	E_{AS}	300 150	mJ

THERMAL CHARACTERISTICS

Characteristic	Symbol	Value	Unit
Thermal Resistance, Junction to Case	$R_{\theta JC}$	1.0	$^\circ\text{C/W}$
Thermal Resistance, Junction to Ambient	TO-220 $R_{\theta JA}$	62.5	
	D ² PAK $R_{\theta JA}$	50	
Maximum Lead Temperature for Soldering Purposes, 1/8" from case for 5 seconds	T_L	275	$^\circ\text{C}$

ELECTRICAL CHARACTERISTICS ($T_C = 25^\circ\text{C}$ unless otherwise noted)

Characteristic	Symbol	Test Conditions	Min	Typ	Max	Unit
----------------	--------	-----------------	-----	-----	-----	------

OFF CHARACTERISTICS

Collector-Emitter Clamp Voltage	BV_{CES}	$I_C = 2\text{ mA}$ $T_J = -40^\circ\text{C}$ to 175°C	320	350	380	V_{DC}
Zero Gate Voltage Collector Current	I_{CES}	$V_{CE} = 300\text{ V}$, $V_{GE} = 0$, $T_J = 25^\circ\text{C}$	-	-	40	μADC
		$V_{CE} = 300\text{ V}$, $V_{GE} = 0$, $T_J = 150^\circ\text{C}$	-	-	200	
Reverse Collector-Emitter Leakage Current	I_{ECS}	$V_{CE} = -24\text{ V}$	-	-	1.0	mA
Gate-Emitter Clamp Voltage	BV_{GES}	$I_G = 5\text{ mA}$	17	-	22	V_{DC}
Gate-Emitter Leakage Current	I_{GES}	$V_{GE} = 10\text{ V}$	384	-	1000	μADC
Gate Resistor (Optional)	R_G	-	-	70	-	Ω
Gate Emitter Resistor	R_{GE}	-	10	-	26	k Ω

ON CHARACTERISTICS*

Gate Threshold Voltage	$V_{GE(th)}$	$I_C = 1\text{ mA}$ $V_{GE} = V_{CE}$	1.0	1.8	2.1	V_{DC}
Threshold Temperature Coefficient (Negative)	-	-	-	4.4	-	mV/ $^\circ\text{C}$
Collector-to-Emitter On-Voltage	$V_{CE(on)}$	$I_C = 6\text{ A}$, $V_{GE} = 4\text{ V}$	-	-	1.8	V_{DC}
Collector-to-Emitter On-Voltage	$V_{CE(on)}$	$I_C = 10\text{ A}$, $V_{GE} = 4.5\text{ V}$, $T_J = 150^\circ\text{C}$	-	-	1.8	V_{DC}
Forward Transconductance	gfs	$V_{CE} = 5\text{ V}$, $I_C = 6\text{ A}$	8.0	15	-	Mhos

DYNAMIC CHARACTERISTICS

Input Capacitance	C_{ISS}	$V_{CC} = 15\text{ V}$	-	1000	-	pF
Output Capacitance	C_{OSS}	$V_{GE} = 0\text{ V}$	-	130	-	
Transfer Capacitance	C_{RSS}	$f = 1\text{ MHz}$	-	5.0	-	

*Pulse Test: Pulse Width $\leq 300\ \mu\text{s}$, Duty Cycle $\leq 2\%$.

MGP15N35CL, MGB15N35CL, MGC15N35CL

ELECTRICAL CHARACTERISTICS ($T_C = 25^\circ\text{C}$ unless otherwise noted)

Characteristic	Symbol	Test Conditions	Min	Typ	Max	Unit
----------------	--------	-----------------	-----	-----	-----	------

SWITCHING CHARACTERISTICS*

Turn-Off Delay Time	$t_{d(off)}$	$V_{CC} = 300\text{ V},$ $I_C = 10\text{ A}$	–	13	–	μSec
Fall Time	t_f	$R_G = 1\text{ k}\Omega,$ $L = 300\text{ }\mu\text{H}$	–	6.0	–	
Turn-On Delay Time	$t_{d(on)}$	$V_{CC} = 10\text{ V},$ $I_C = 6.5\text{ A}$	–	1.0	–	μSec
Rise Time	t_r	$R_G = 1\text{ k}\Omega,$ $R_L = 1\text{ }\Omega$	–	5.0	–	
Gate Charge	Q_T	$V_{CC} = 300\text{ V}$	–	TBD	–	nC
	Q_1	$I_C = 15\text{ A}$	–	TBD	–	
	Q_2	$V_{GE} = 5\text{ V}$	–	TBD	–	

*Pulse Test: Pulse Width $\leq 300\text{ }\mu\text{s}$, Duty Cycle $\leq 2\%$.

MGP15N35CL, MGB15N35CL, MGC15N35CL

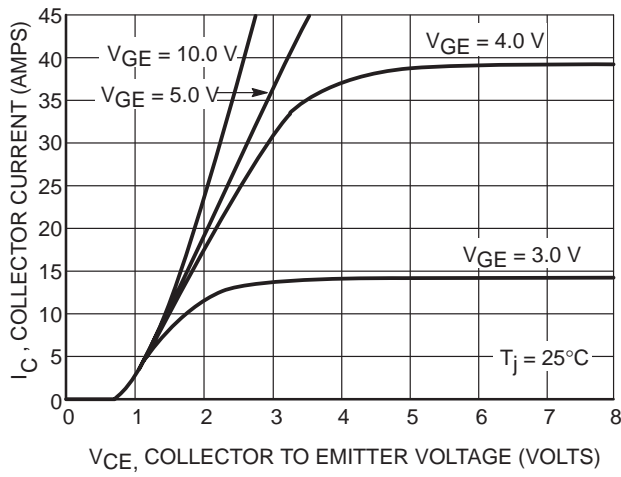

Figure 1. Output Characteristics

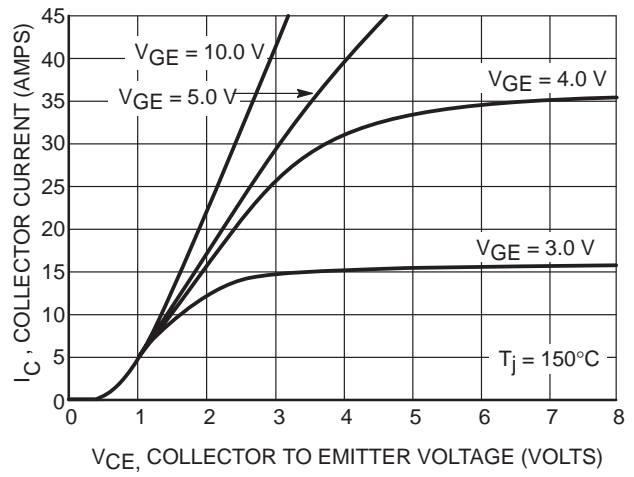

Figure 2. Output Characteristics

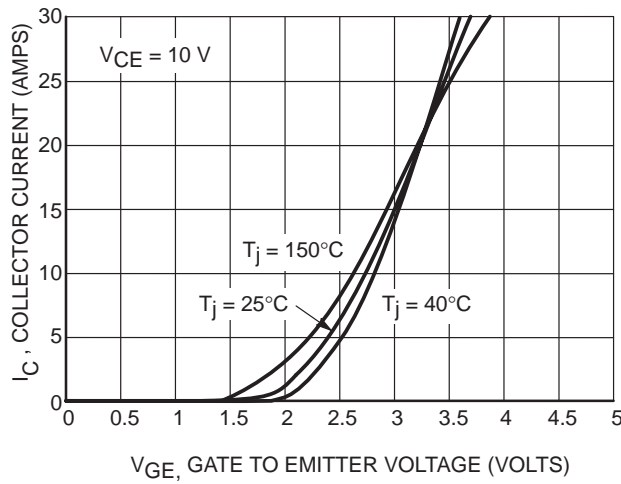

Figure 3. Transfer Characteristics

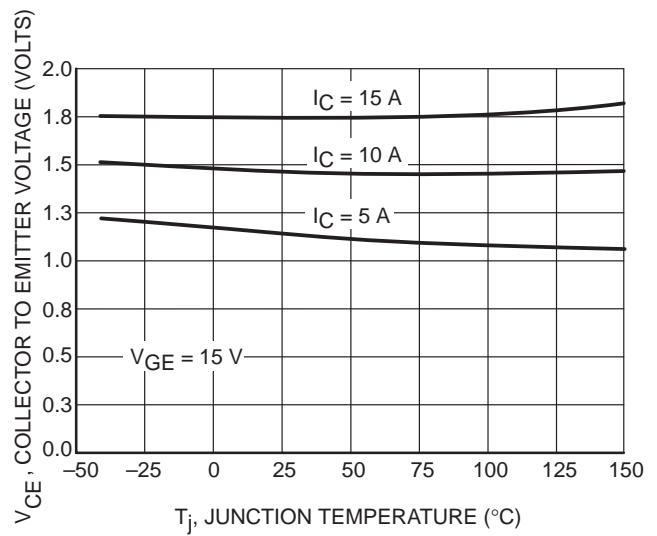

Figure 4. Collector-to-Emitter Saturation Voltage versus Junction Temperature

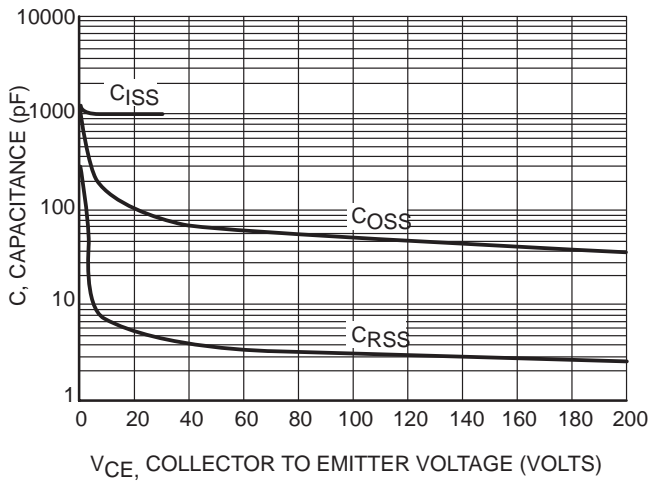

Figure 5. Capacitance Variation

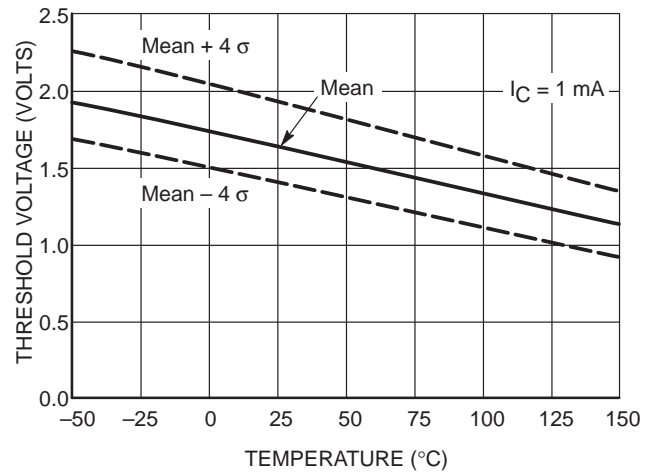

Figure 6. Threshold Voltage versus Temperature

MGP15N35CL, MGB15N35CL, MGC15N35CL

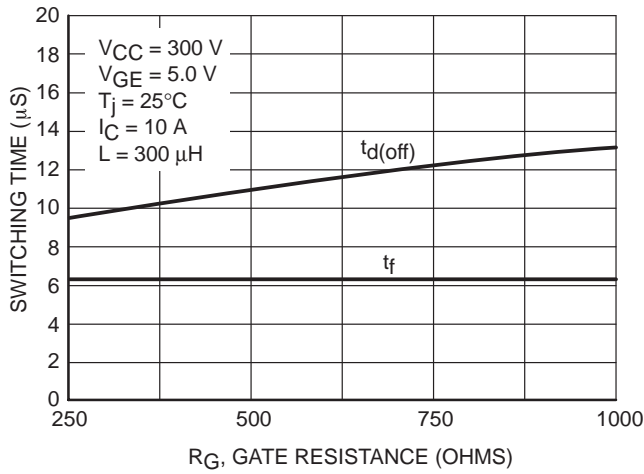

Figure 7. Switching Speed versus Gate Resistance

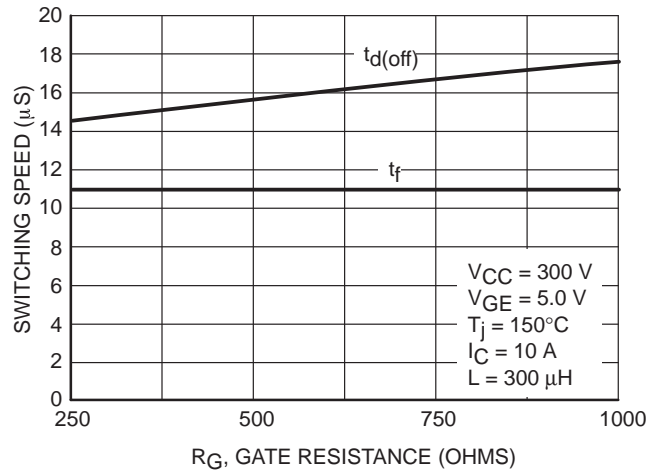

Figure 8. Switching Speed versus Gate Resistance

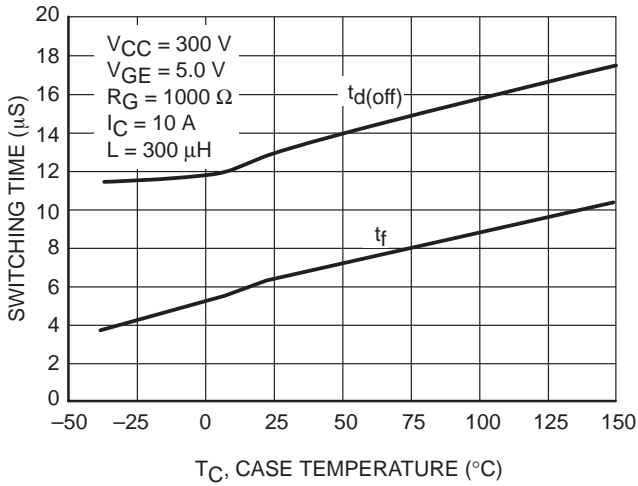

Figure 9. Switching Speed versus Case Temperature

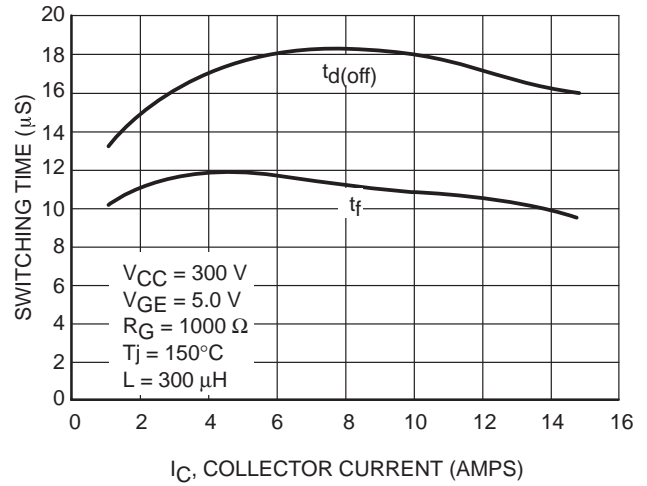

Figure 10. Total Switching Losses versus Collector Current

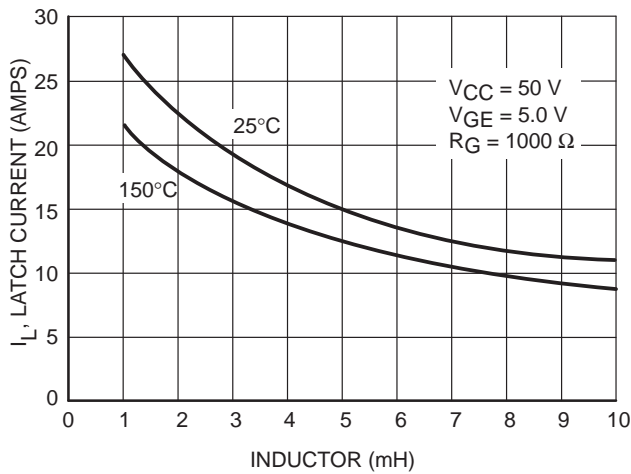

Figure 11. Latch Current versus Inductor (Typical)

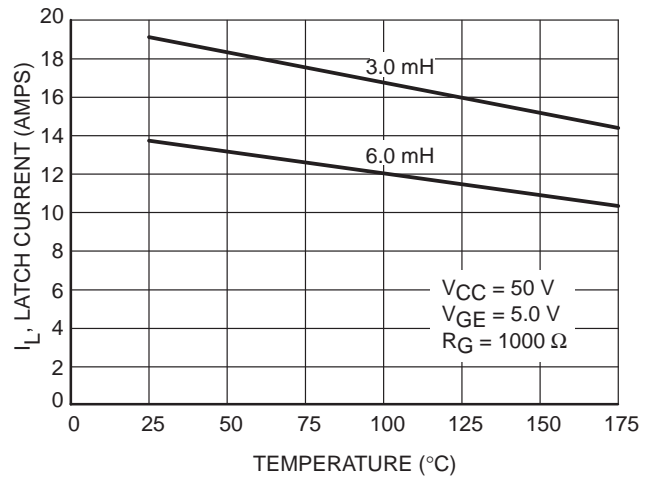
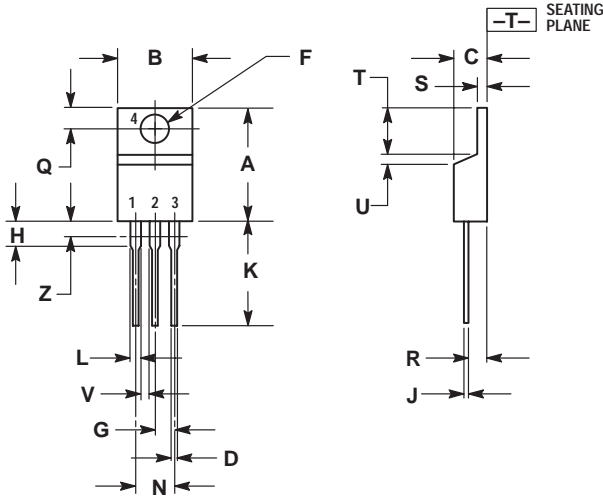

Figure 12. Latch Current versus Temperature (Typical)

MGP15N35CL, MGB15N35CL, MGC15N35CL

PACKAGE DIMENSIONS

TO-220 CASE 221A-09 ISSUE AA



NOTES:

1. DIMENSIONING AND TOLERANCING PER ANSI Y14.5M, 1982.
2. CONTROLLING DIMENSION: INCH.
3. DIMENSION Z DEFINES A ZONE WHERE ALL BODY AND LEAD IRREGULARITIES ARE ALLOWED.

DIM	INCHES		MILLIMETERS	
	MIN	MAX	MIN	MAX
A	0.570	0.620	14.48	15.75
B	0.380	0.405	9.66	10.28
C	0.160	0.190	4.07	4.82
D	0.025	0.035	0.64	0.88
F	0.142	0.147	3.61	3.73
G	0.095	0.105	2.42	2.66
H	0.110	0.155	2.80	3.93
J	0.018	0.025	0.46	0.64
K	0.500	0.562	12.70	14.27
L	0.045	0.060	1.15	1.52
N	0.190	0.210	4.83	5.33
Q	0.100	0.120	2.54	3.04
R	0.080	0.110	2.04	2.79
S	0.045	0.055	1.15	1.39
T	0.235	0.255	5.97	6.47
U	0.000	0.050	0.00	1.27
V	0.045	---	1.15	---
Z	---	0.080	---	2.04

STYLE 9:

- PIN 1. GATE
- COLLECTOR
- EMITTER
- COLLECTOR

D2PAK CASE 418B-03 ISSUE D

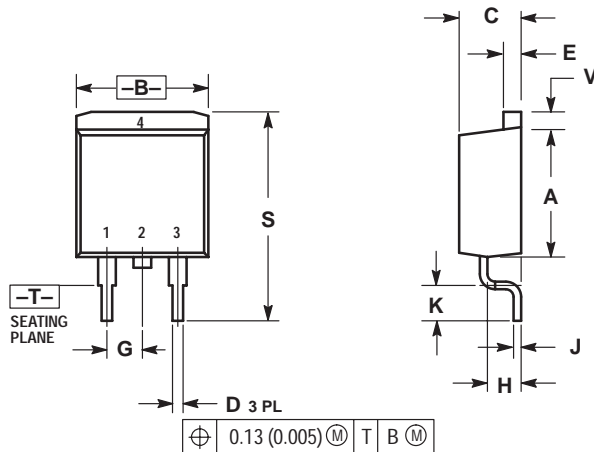

NOTES:

1. DIMENSIONING AND TOLERANCING PER ANSI Y14.5M, 1982.
2. CONTROLLING DIMENSION: INCH.

DIM	INCHES		MILLIMETERS	
	MIN	MAX	MIN	MAX
A	0.340	0.380	8.64	9.65
B	0.380	0.405	9.65	10.29
C	0.160	0.190	4.06	4.83
D	0.020	0.035	0.51	0.89
E	0.045	0.055	1.14	1.40
G	0.100 BSC		2.54 BSC	
H	0.080	0.110	2.03	2.79
J	0.018	0.025	0.46	0.64
K	0.090	0.110	2.29	2.79
S	0.575	0.625	14.60	15.88
V	0.045	0.055	1.14	1.40

STYLE 3:

- PIN 1. ANODE
- CATHODE
- ANODE
- CATHODE

Notes

MGP15N35CL, MGB15N35CL, MGC15N35CL

TMOS is a trademark of Semiconductor Components Industries, LLC.

ON Semiconductor and  are trademarks of Semiconductor Components Industries, LLC (SCILLC). SCILLC reserves the right to make changes without further notice to any products herein. SCILLC makes no warranty, representation or guarantee regarding the suitability of its products for any particular purpose, nor does SCILLC assume any liability arising out of the application or use of any product or circuit, and specifically disclaims any and all liability, including without limitation special, consequential or incidental damages. "Typical" parameters which may be provided in SCILLC data sheets and/or specifications can and do vary in different applications and actual performance may vary over time. All operating parameters, including "Typicals" must be validated for each customer application by customer's technical experts. SCILLC does not convey any license under its patent rights nor the rights of others. SCILLC products are not designed, intended, or authorized for use as components in systems intended for surgical implant into the body, or other applications intended to support or sustain life, or for any other application in which the failure of the SCILLC product could create a situation where personal injury or death may occur. Should Buyer purchase or use SCILLC products for any such unintended or unauthorized application, Buyer shall indemnify and hold SCILLC and its officers, employees, subsidiaries, affiliates, and distributors harmless against all claims, costs, damages, and expenses, and reasonable attorney fees arising out of, directly or indirectly, any claim of personal injury or death associated with such unintended or unauthorized use, even if such claim alleges that SCILLC was negligent regarding the design or manufacture of the part. SCILLC is an Equal Opportunity/Affirmative Action Employer.

PUBLICATION ORDERING INFORMATION

NORTH AMERICA Literature Fulfillment:

Literature Distribution Center for ON Semiconductor
P.O. Box 5163, Denver, Colorado 80217 USA
Phone: 303-675-2175 or 800-344-3860 Toll Free USA/Canada
Fax: 303-675-2176 or 800-344-3867 Toll Free USA/Canada
Email: ONlit@hibbertco.com
Fax Response Line: 303-675-2167 or 800-344-3810 Toll Free USA/Canada

N. American Technical Support: 800-282-9855 Toll Free USA/Canada

EUROPE: LDC for ON Semiconductor – European Support

German Phone: (+1) 303-308-7140 (M-F 1:00pm to 5:00pm Munich Time)
Email: ONlit-german@hibbertco.com
French Phone: (+1) 303-308-7141 (M-F 1:00pm to 5:00pm Toulouse Time)
Email: ONlit-french@hibbertco.com
English Phone: (+1) 303-308-7142 (M-F 12:00pm to 5:00pm UK Time)
Email: ONlit@hibbertco.com

EUROPEAN TOLL-FREE ACCESS*: 00-800-4422-3781

*Available from Germany, France, Italy, England, Ireland

CENTRAL/SOUTH AMERICA:

Spanish Phone: 303-308-7143 (Mon-Fri 8:00am to 5:00pm MST)
Email: ONlit-spanish@hibbertco.com

ASIA/PACIFIC: LDC for ON Semiconductor – Asia Support

Phone: 303-675-2121 (Tue-Fri 9:00am to 1:00pm, Hong Kong Time)
Toll Free from Hong Kong & Singapore:
001-800-4422-3781
Email: ONlit-asia@hibbertco.com

JAPAN: ON Semiconductor, Japan Customer Focus Center
4-32-1 Nishi-Gotanda, Shinagawa-ku, Tokyo, Japan 141-8549

Phone: 81-3-5740-2745
Email: r14525@onsemi.com

ON Semiconductor Website: <http://onsemi.com>

For additional information, please contact your local Sales Representative.