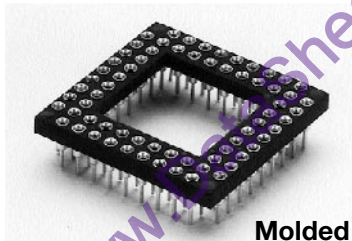
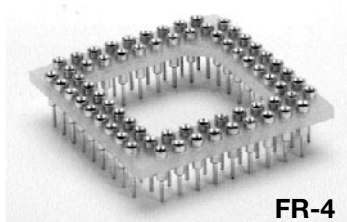
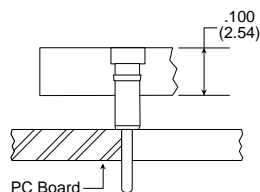
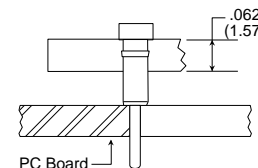

Molded & FR-4 Low Insertion Force PGA Sockets

Molded

FR-4

Features:

- As low as 1 oz.(28.34 g) average insertion force per pin.
- Multiple finger contacts for reliability.
- Over 500 PGA footprints available.
- Closed bottom terminal for 100% anti-wicking of solder.
- Tapered entry for ease of insertion.
- To fit .100" (2.54 mm) grid.
- Easily customized to fit your application.

Terminals and Contacts:

Terminal: Brass - Copper Alloy (C36000)
ASTM-B-16

Contact: Beryllium Copper (C17200)
ASTM-B-194

Solder Preform:

63% Tin, 37% Lead

Plating:

Terminal: Gold over Nickel or
Tin-Lead over Nickel

Contact: Gold over Nickel or
Tin-Lead over Nickel

Gold per MIL-G-45204

Tin-Lead per MIL-P-81728

Nickel per QQ-N-290

Body Material:

CS/CIS - Glass Filled Thermoplastic Polyester (P.B.T.), U.L. Rated 94V-O, -60°C to 140°C (-76°F to 284°F)

HCS/HCIS - High Temp. Glass Filled Thermoplastic (P.P.S.), U.L. Rated 94V-O, -60°C to 260°C (-76°F to 500°F)

FS/FIS - FR-4 Fiberglass Epoxy Board, U.L. Rated 94V-O, Index 140°C (284°F)

How To Order

1 oz. (28.34 g) Average Insertion Force Sockets

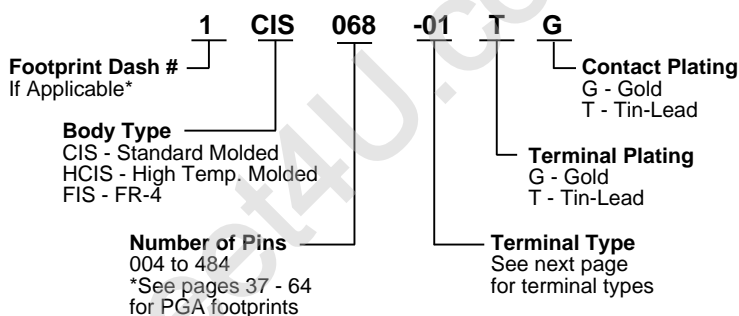

How To Order

2.5 oz. (70.85 g) Average Insertion Force Sockets

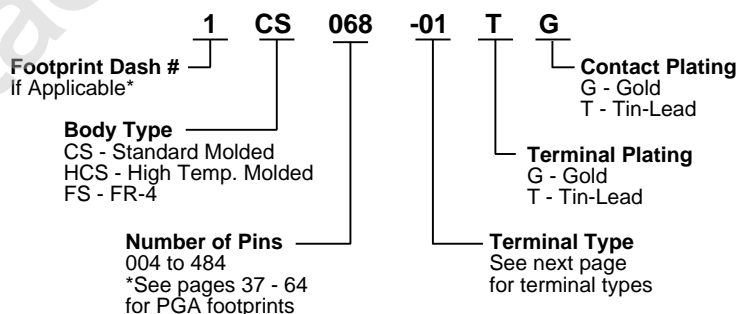

Sealant Options

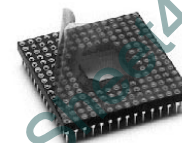

RTV Sealed

Tape Sealed

To order: Add RTV to end of part #
Note: RTV not available with HCS or HCIS Insulators

To order: Add 3M to end of part #

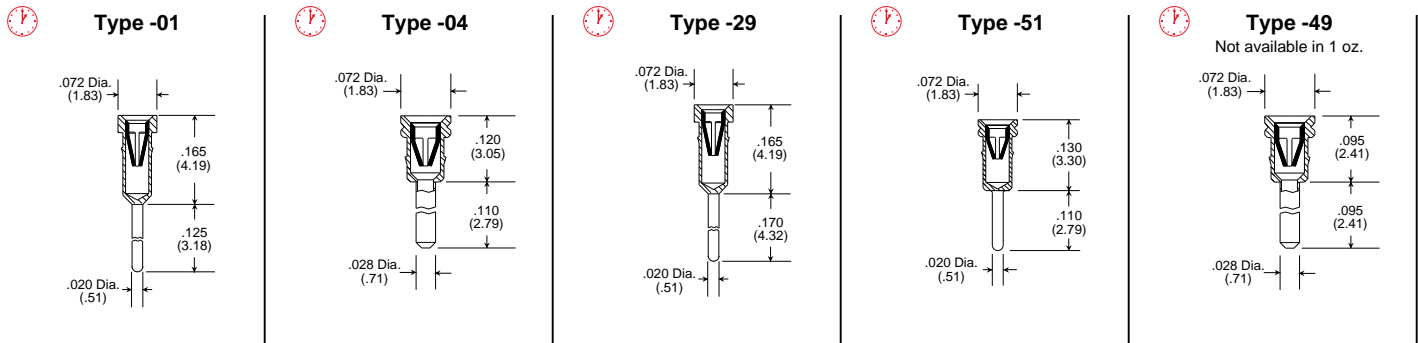
Terminals for Molded & FR-4 Low Insertion Force PGA Sockets

Standard Quick Turn Terminal



Quick turn delivery available on standard terminal types.

Additional terminal types available. See terminal section for detailed terminal information.

PGA

Solder Preform PGA Sockets - Intrusive Reflow Application

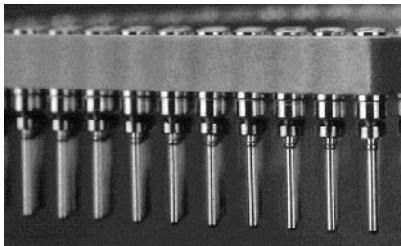

Features:

- Combines the labor of socket loading and solder application into one operation.
- Eliminates the use of solder paste and screening operation.
- Eliminates solder bridges and/or solder shorts due to excess solder.
- Ensures a reliable solder joint with controlled solder volume.
- Ideal for surface mount and mixed technology applications.
- For custom solder preform terminal applications consult factory.
- See previous page for material specifications and how to order information.

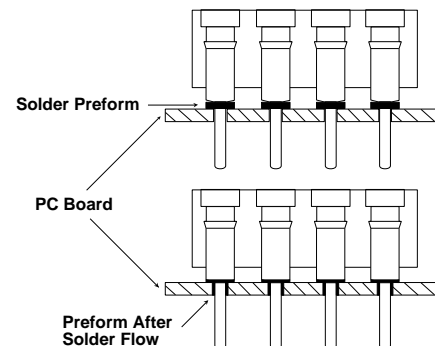

Solder Preform Terminals

