



DOCUMENT NUMBER AND REVISION

VL-FS-MGLS12864T-73 REV. A
(MGLS12864T-FSTN-LED05W)

DOCUMENT TITLE:

SPECIFICATION

OF

LCD MODULE TYPE

MODEL NUMBER: MGLS12864T-73

DEPARTMENT	NAME	SIGNATURE	DATE
PREPARED BY	SUNNY LEE	<i>Sunny Lee</i>	2003.6.6
CHECKED BY	YU HAO	<i>YH</i>	2003.06.06
APPROVED BY	DERRICK TAM	<i>Derrick</i>	2003.6.6

DISTRIBUTION LIST: MARKETING



DOCUMENT REVISION HISTORY 1:

DOCUMENT REVISION FROM TO	DATE	DESCRIPTION	CHANGED BY	CHECKED BY
A	2003.06.02	Based on document VL-TS-MGLS12864T-XX REV. L, (03-04-15).	SUNNY LEE	YU HAO



CONTENTS

	<u>Page No.</u>
1. GENERAL DESCRIPTION	4
2. MECHANICAL SPECIFICATIONS	4
3. INTERFACE SIGNALS	6
4. ABSOLUTE MAXIMUM RATINGS	7
4.1 ELECTRICAL MAXIMUM RATINGS (Ta=25°C)	7
4.2 ENVIRONMENTAL CONDITION	7
5. ELECTRICAL SPECIFICATIONS	8
5.1 TYPICAL ELECTRICAL CHARACTERISTICS	8
5.2 TIMING SPECIFICATIONS	9
5.3 TIMING DIAGRAM OF VDD AGAINST V0	10
6. APPENDIX – LED SPECIFICATION	11



VARITRONIX LIMITED

Specification of LCD Module Type Model No.: MGLS12864T-73

1. General Description

- 128 x 64 dots FSTN Positive Black & White Transflective LCD graphic module.
- Driving scheme: 1:64 multiplexed drive, 1/9 bias.
- Viewing direction: 6 O'clock.
- 'TOSHIBA' T6963C flat pack or equivalent LCD controller.
- 'TOSHIBA' T6A39 flat pack or equivalent LCD segment drivers.
- 'TOSHIBA' T6A40 flat pack or equivalent LCD common driver.
- 8K bytes display SRAM.
- White LED05 backlight.

2. Mechanical Specifications

The mechanical detail is shown in Fig. 1 and summarized in Table 1 below.

Table 1

Parameter	Specifications	Unit
Outline dimensions	78.0(W) x 70.0(H) x 13.5 MAX.(D) (Excluded cable)	mm
Viewing area	62.0(W) x 44.0(H)	mm
Active area	56.27(W) x 38.35(H)	mm
Display format	128(Horizontal) x 64(Vertical)	dots
Dot size	0.39(W) x 0.55(H)	mm
Dot spacing	0.05(W) x 0.05(H)	mm
Dot pitch	0.44(W) x 0.60(H)	mm
Weight	TBD	gram

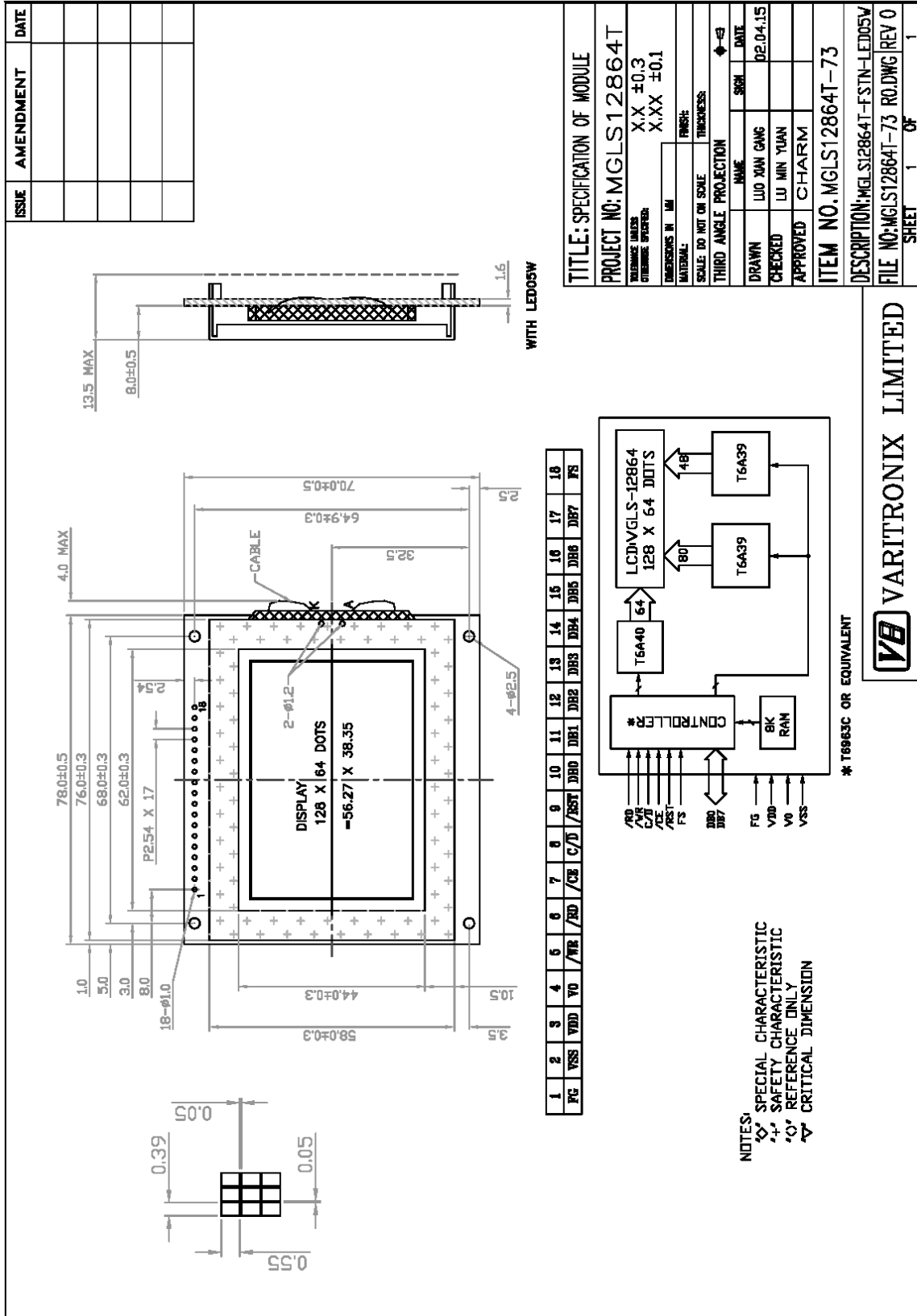

Figure 1: Outline drawing of MGLS12864T-73



3. Interface signals

Table 2

Pin No.	Symbol	Description
1	FG	Frame ground (see note 1)
2	VSS	Ground (0V)
3	VDD	Power supply for logic (+5V)
4	V0	Power supply for LCD drive
5	/WR	Command/Data write to module when "Low"
6	/RD	Command/Data read from module when "Low"
7	/CE	Chip enable of controller when "Low"
8	C / \bar{D}	Command/Data read/write. "High" for command read/write and "Low" for data read/write
9	/RST	Controller reset when "Low"
10	DB0	Data input/output (LSB)
11	DB1	Data input/output
12	DB2	Data input/output
13	DB3	Data input/output
14	DB4	Data input/output
15	DB5	Data input/output
16	DB6	Data input/output
17	DB7	Data input/output (MSB)
18	FS	Font select. "High" for 6 x 8 font & "Low" for 8 x 8 font.
-	K	Cathode of backlight
-	A	Anode of backlight

Note 1: This pin is electrically connected to the metal bezel (frame).
User can choose to connect this pin to VSS or leave it open.



4. Absolute Maximum Ratings

4.1 Electrical Maximum Ratings (Ta = 25 °C)

Table 3

Parameter	Symbol	Min.	Max.	Unit
Supply voltage (Logic & LCD)	VDD - VSS	-0.3	+7.0	V
Supply voltage (LCD drive)	VLCD=VDD - V0	-0.3	+28.0	V
Input voltage	Vin	-0.3	VDD +3.0	V

Note:

The modules may be destroyed if they are used beyond the absolute maximum ratings.

All voltage values are referenced to VSS = 0V.

4.2 Environmental Condition

Table 4

Item	Operating Temperature (Topr)		Storage Temperature (Tstg)		Remark
	Min.	Max.	Min.	Max.	
Ambient Temperature	0°C	+50°C	-10°C	+60°C	Dry
Humidity	95% max. RH for Ta ≤ 40°C < 95% RH for Ta > 40°C				no condensation
Vibration (IEC 68-2-6) cells must be mounted on a suitable connector	Frequency: 10 ~ 55 Hz Amplitude: 0.75 mm Duration: 20 cycles in each direction.				3 directions
Shock (IEC 68-2-27) Half-sine pulse shape	Pulse duration : 11 ms Peak acceleration: 981 m/s ² = 100g Number of shocks : 3 shocks in 3 mutually perpendicular axes.				3 directions



5. Electrical Specifications

5.1 Typical Electrical Characteristics

At $T_a = 25\text{ }^\circ\text{C}$, $V_{DD} = 5V \pm 5\%$, $V_{SS} = 0V$.

Table 5

Parameter	Symbol	Conditions	Min.	Typ.	Max.	Unit
Supply voltage (Logic)	$V_{DD} - V_{SS}$		4.75	5.00	5.25	V
Supply voltage (LCD)	$V_{LCD} = V_{DD} - V_0$	$V_{DD} = 5V$, Note 1	9.7	10.2	10.7	V
Input signal voltage	V_{IN}	“H” level	$V_{DD} - 2.2$	-	V_{DD}	V
		“L” level	0	-	0.8	V
Supply current (Logic & LCD)	I_{DD}	Character mode, $V_{DD} = 5V$, Note 1	-	6.5	9.8	mA
		Checker board mode, $V_{DD} = 5V$, Note 1	-	6.6	9.9	mA
Supply current (LCD)	I_0	Character mode, $V_{DD} = 5V$, Note 1	-	2.2	3.3	mA
		Checker board mode, $V_{DD} = 5V$, Note 1	-	2.2	3.3	mA
Supply voltage of white LED05 backlight	V_{LED05}	Forward current = 40 mA Number of LED dies = $1 \times 2 = 2$.	3.1	3.4	3.6	V

Note 1: There is tolerance in optimum LCD driving voltage during production and it will be within the specified range.



5.2 Timing Specifications

At $T_a = 0^\circ\text{C}$ To $+50^\circ\text{C}$, $V_{DD} = 5V \pm 5\%$, $V_{SS} = 0V$

Refer to Fig. 2, the bus timing diagram.

Table 6

Parameter	Symbol	Min.	Max.	Unit
C/D Set-up time	t_{CDS}	100	-	ns
C/D Hold Time	t_{CDH}	10	-	ns
/CE, /RD, /WR Pulse Width	t_{CE}, t_{RD}, t_{WR}	80	-	ns
Data Set-up Time	t_{DS}	80	-	ns
Data Hold Time	t_{DH}	40	-	ns
Access Time	t_{ACC}	-	150	ns
Output Hold Time	t_{OH}	10	50	ns

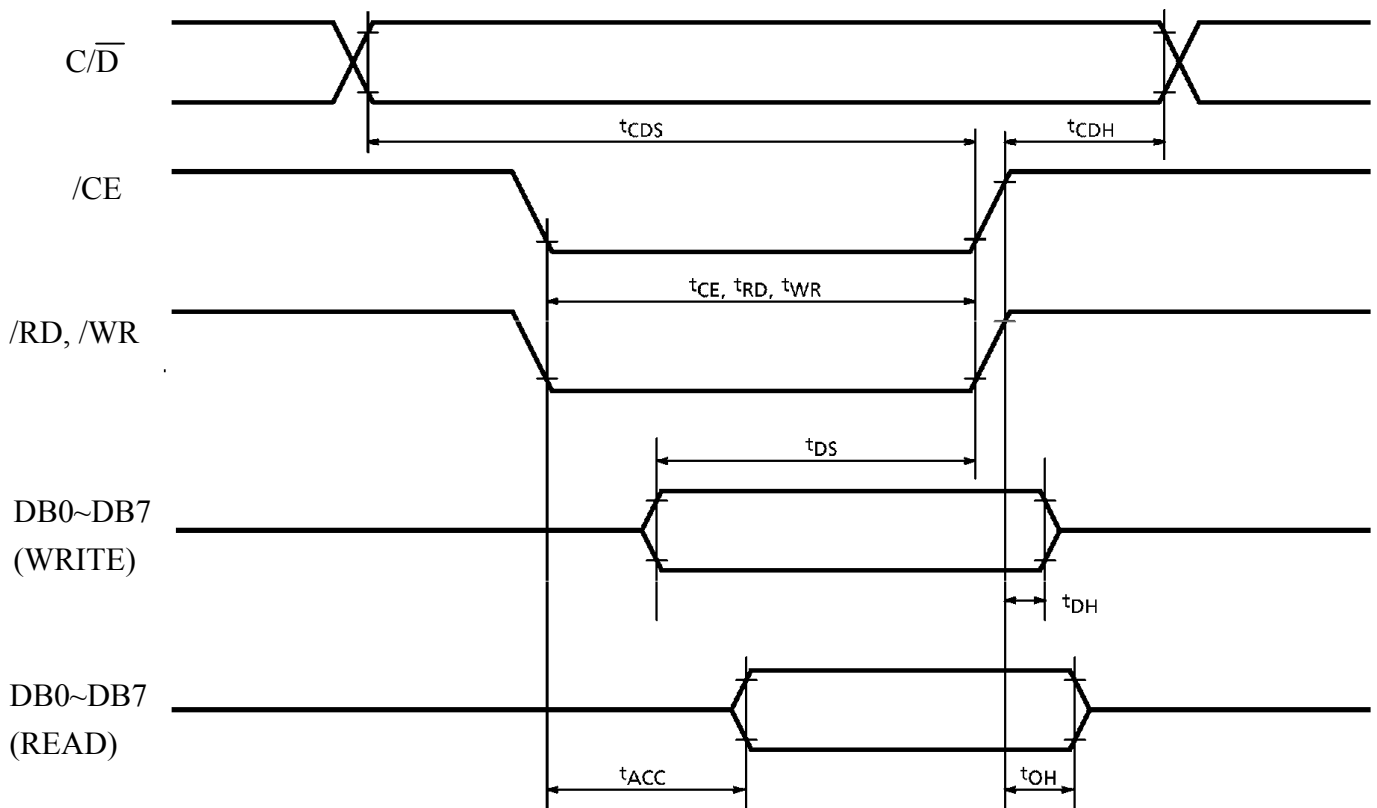

Figure 2: Bus Timing Diagram



5.3 Timing Diagram of VDD Against V0.

Power on sequence shall meet the requirement of Figure 3, the timing diagram of VDD against V0.

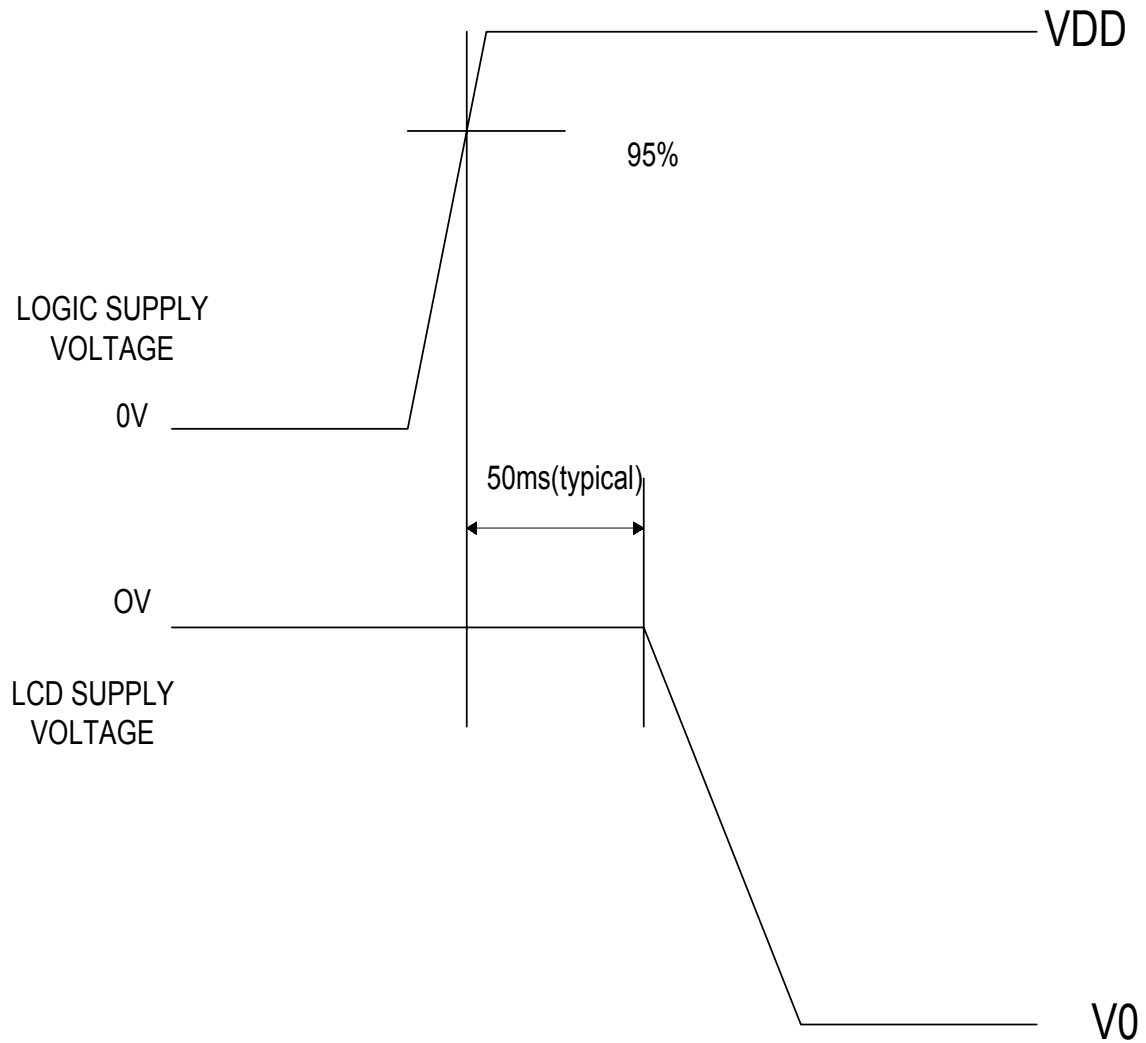
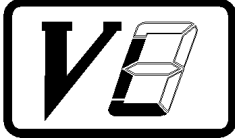

Figure 3: Timing Diagram of VDD Against V0.



6. APPENDIX – LED SPECIFICATION

1. 极限参数 ABSOLUTE MAXIMUM RATINGS

(除非特别说明,环境温度 Ta=25°C. Unless specified, The Ambient temperature Ta=25°C)

项目 Item	符号 Symbol	条件 Conditions	值 Rating	单位 Unit
* 极限直流正向电流 Absolute maximum forward current	Ifm		25x2	mA
* 脉冲驱动时极限正向电流 Peak forward current	Ifp	1 msec 脉冲, 1/10 占空比 1 msec Plus 10% Duty Cycle	60x2	mA
反向电压 Reverse Voltage	Vr		5	V
* 极限功耗 Power dissipation	Pd		75x2	mW
工作温度 Operating Temperature Range	Topr		-30~+70°C	°C
贮存温度 Storage Temperature Range	Tstg		-40~+80°C	°C

* 当工作温度高于 25°C 时, Ifm, Ifp 和 Pd 必须降低; 电流降低率是 -0.36x2 mA/°c (直流驱动), 或 -0.86x2 mA/°c (脉冲驱动), 功耗降低率是 -0.75x2 mW/°C. 产品的工作电流不能大于对应工作温度条件 Ifm 或 Ifp 的 60 %.
For operation above 25°C, The Ifm Ifp & Pd must be derated, the Current derating is -0.36x2 mA/°c for DC drive and -0.86x2 mA/°c for Pulse drive, the Power dissipation is -0.75x2 mW/°c. The product working current must not more than the 60 % of the Ifm or Ifp according to the working temperature.

2. 电.光特性 ELECTRICAL-OPTICAL CHARACTERISTICS

(除非特别说明,环境温度 Ta=25°C. Unless specified, The Ambient temperature Ta=25°C)

项目 Item	符号 Symbol	最小值 min.	典型值 typ.	最大值 max.	单位 Unit	测定条件 Condition
正向电压 Forward Voltage	Vf	3.3	3.5	3.8	V	If= 20x2 mA
反向电流 Reverse Current	Ir			15X2	μA	Vr= 3 V
峰值波长 Peak wave length	λP				nm	If= 20x2 mA
频谱半宽度 Spectral Line Half width	Δλ				nm	If= 20x2 mA
* 亮度 Luminance	Lv	130	170		cd/m²	If= 20x2 mA

Color Ranks

	Rank b1			
X	0.287	0.283	0.330	0.330
Y	0.295	0.305	0.360	0.339

	Rank b2			
X	0.296	0.287	0.330	0.330
Y	0.276	0.295	0.339	0.318

* 亮度值是 9 个测量点的平均值, 亮度最大值比最小值一般小于 2.5 (最大 2.8). 使用 BM-7 亮度色度仪测量, 测量光圈 φ 10 mm.

The luminance is the average value of 9 points, and The Lvmax./Lvmin. is less than 2.5 Typical (max 2.8). The measurement instrument is BM-7 luminance Colorimeter. The aperture is φ 10 mm.

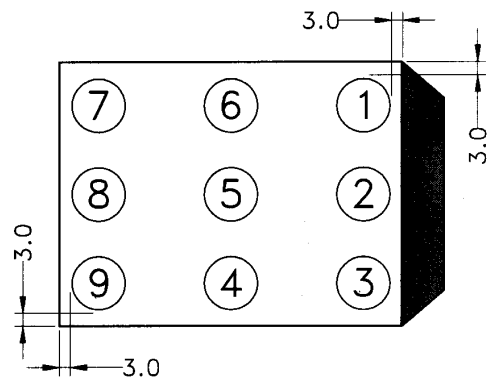



3. STATIC ELECTRICITY AND SURGE

- * Static electricity and surge will damage the LEDs. It is recommended to use a wrist band or anti-electrostatic glove when handling the LEDs.
- * All devices, equipment and machinery must be properly grounded.
- * When inspecting own final products on which LEDs were mounted, it is recommended to check also whether the mounted LEDs are damaged by static electricity or not. It is easy to find static-damaged LEDs by light emission test at lower current (below 1mA is recommended). Damaged LEDs will show some unusual characteristics such as leak current remarkably increases, starting forward voltage becomes lower, or the LEDs get unlighted at the low current.

4. RECOMMEND CONNECTION OF STATIC-ELECTRICITY RESISTANCE

- * This circuit diagram is a common ESD protection circuit for all super bright blue, white and green color LED backlight application.

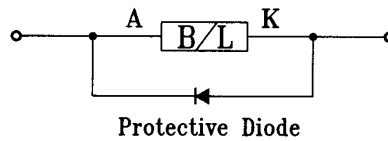

5. LED ELECTRICAL CHARACTERISTICS

(1) 正向电流-周围温度
Forward Current VS. Ambient Temperature

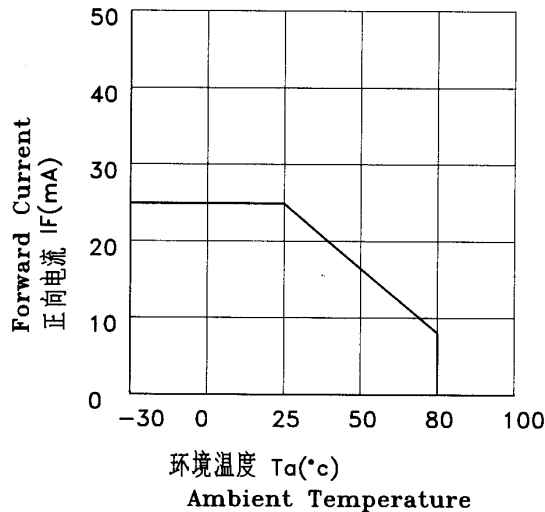

(2) 正向电流-正向电压特性
Forward Current VS. Forward Voltage

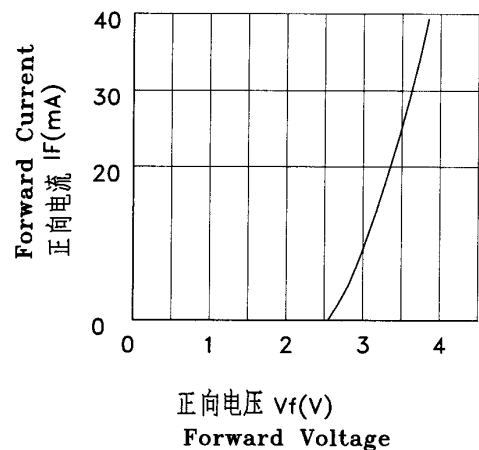



ICI Chromaticity Diagram

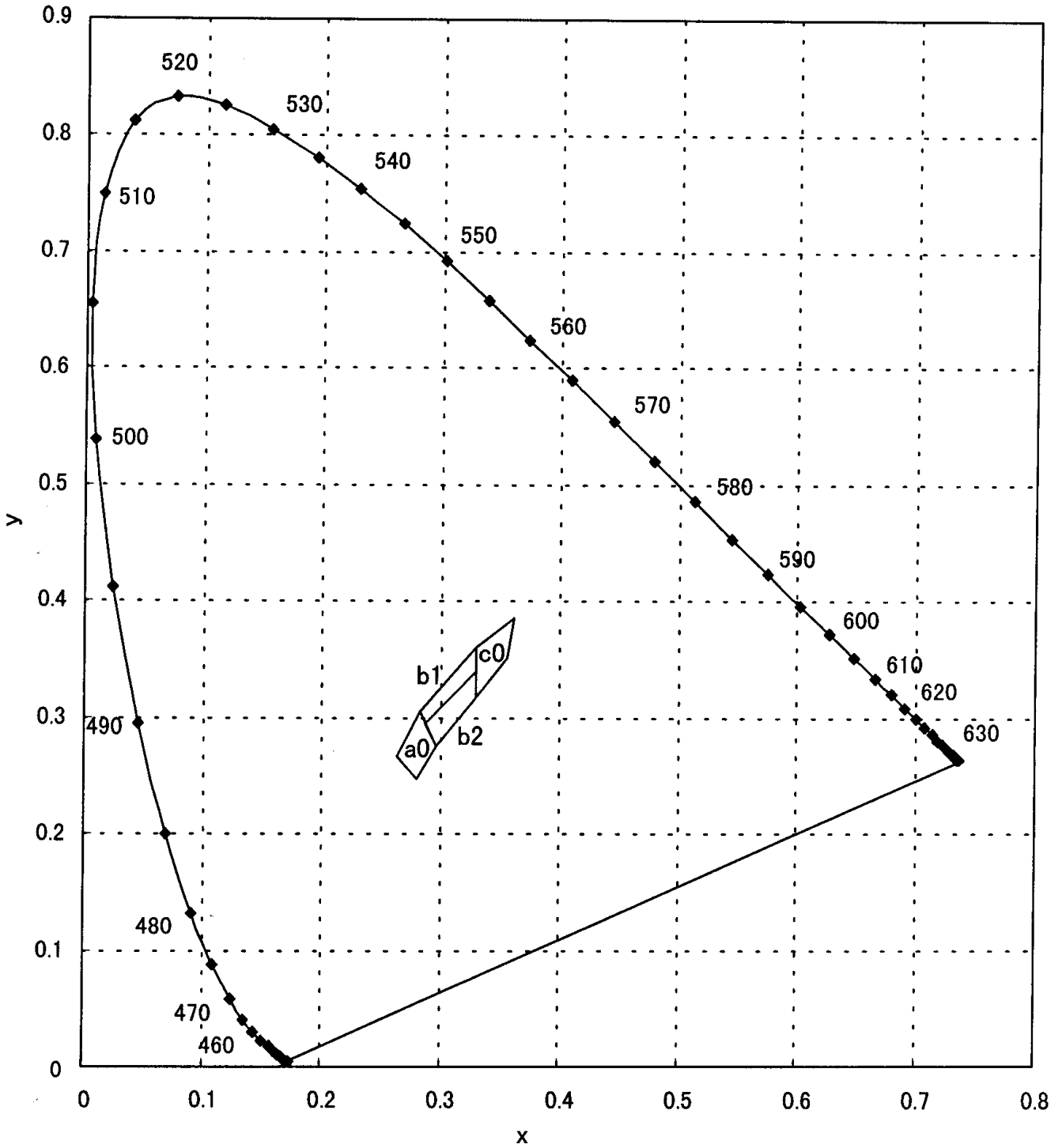

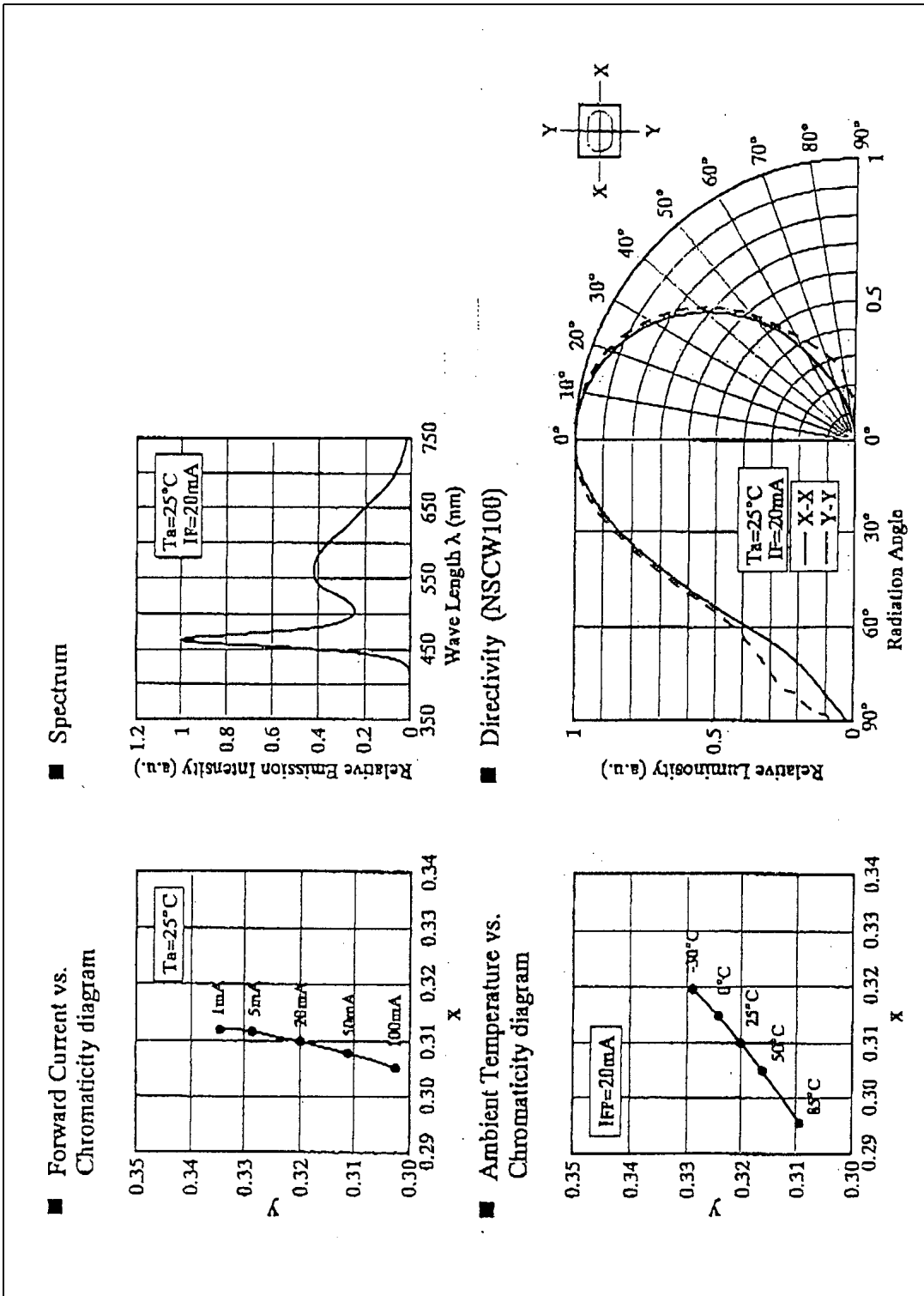

“Varitronix Limited reserves the right to change this specification.”

FAX: (852) 2343-9555.

URL: <http://www.varitronix.com>

- END -