

Lithium Manganese Dioxide Battery **CR2430**

■ Dimensions (mm)

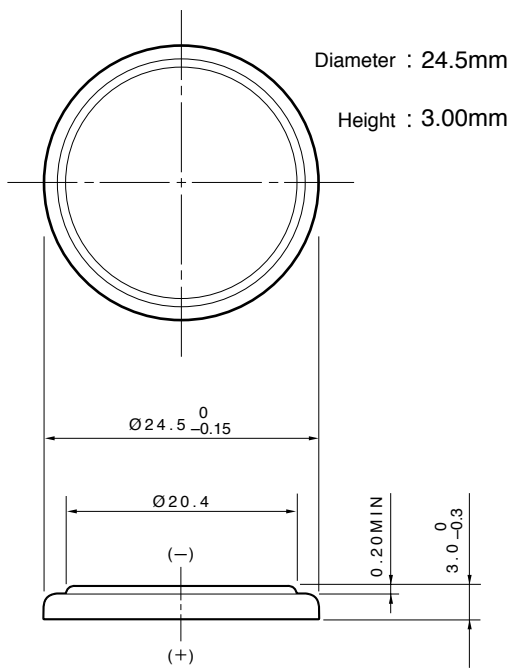

■ Specifications

Nominal Voltage	<b>3V</b>
Nominal Capacity (2.5V cutoff)	<b>280mAh</b>
Recommended Continuous Drain	<b>0.4mA</b>
Recommended Pulse Drain	<b>21mA</b>
Weight	<b>4.6g</b>

Applications

- Memory Back-up Power Source for SRAM or Real Time Clock (RTC)

■ Discharge Characteristics

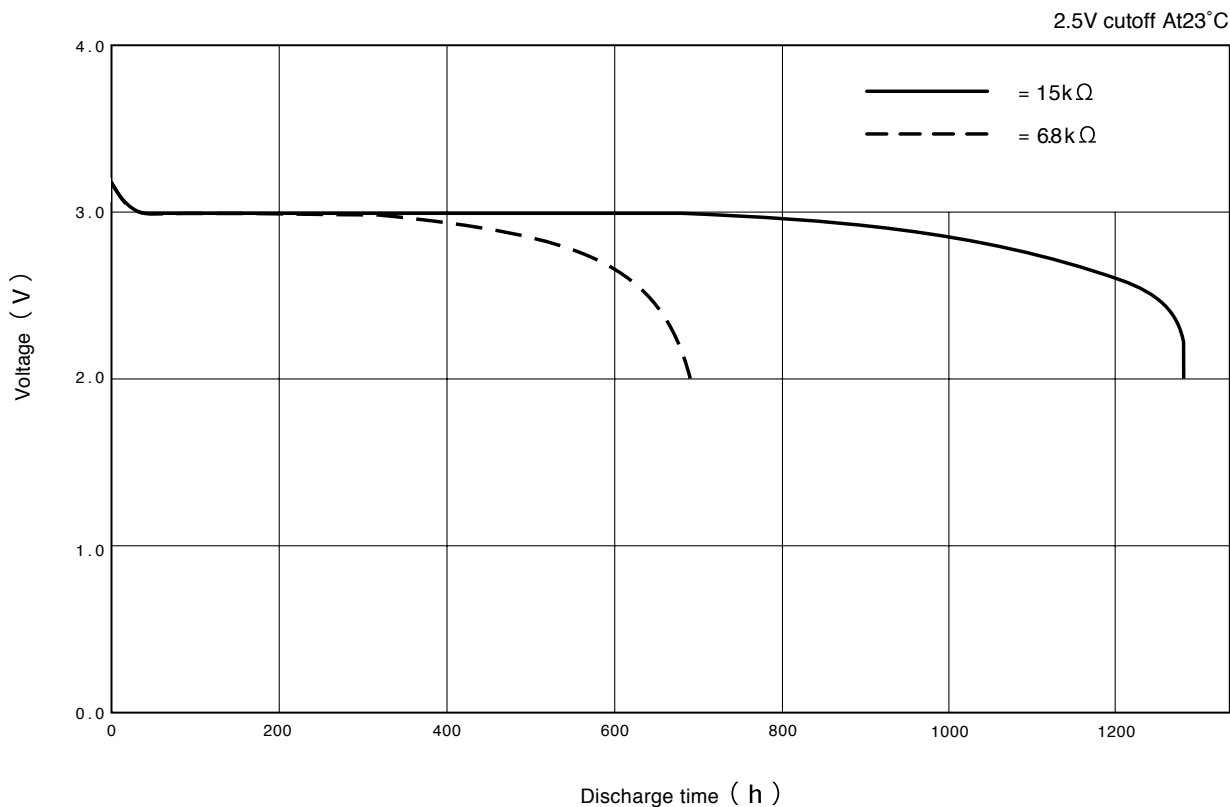

Discharge Characteristics on Load

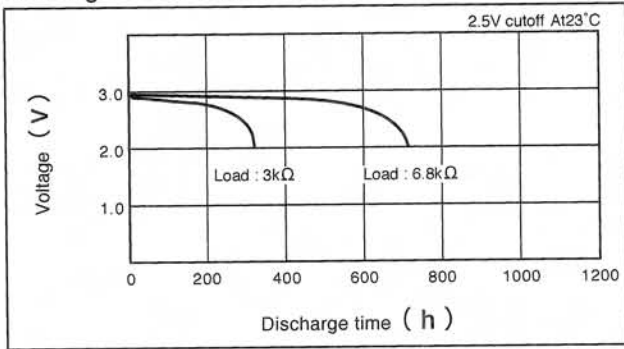

Discharge Characteristics on Temperature

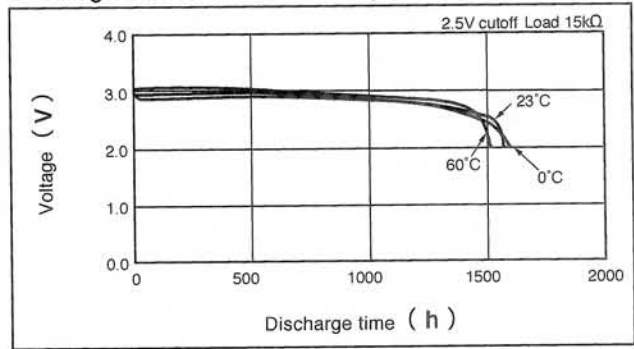

Discharge Load vs. Operation Voltage (Discharge depth 40%)

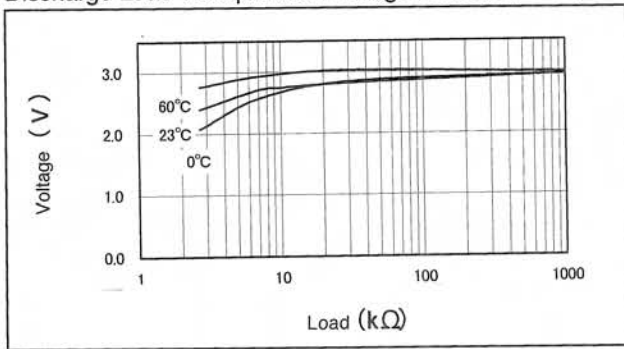

Discharge Load vs. Discharge Capacity

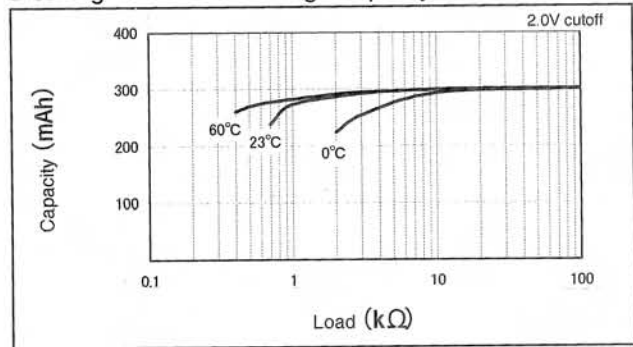

Discharge Characteristics on Pulse Load (Discharge depth 40%)

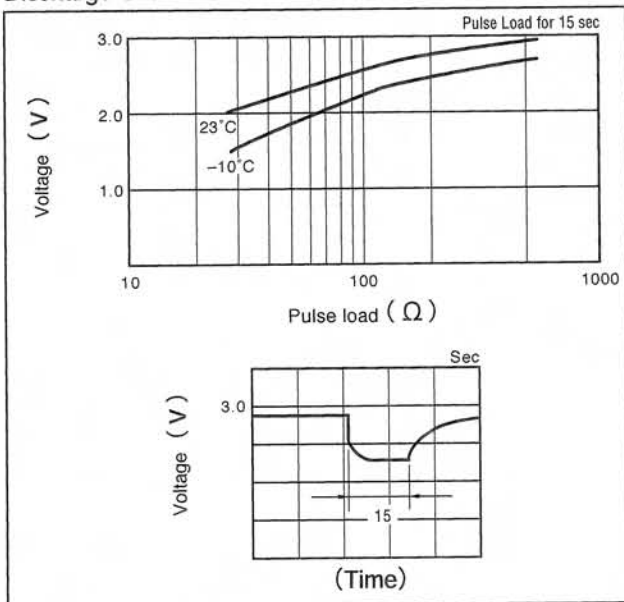

Storage Characteristics

