

16 CHARACTERS X 2 LINES

CHARACTER SIZE: 2.54W X 3.55H mm (5 X 7 DOTS)  
2.54W X 4.07H mm (5 X 8 DOTS)

# MDL(S)-16264

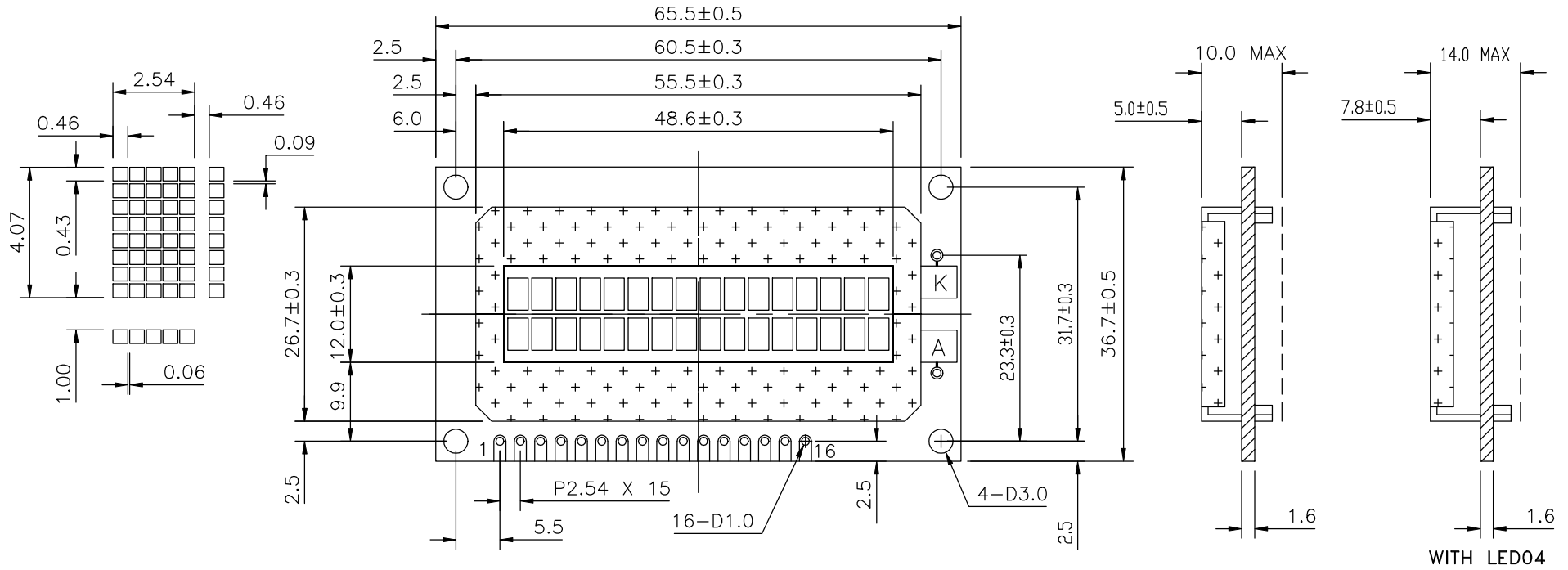

14 PIN CONNECTION	1	2	3	4	5	6	7	8	9	10	11	12	13	14	A	K
16 PIN CONNECTION	1	2	3	4	5	6	7	8	9	10	11	12	13	14	15	16
	VSS	VDD	V0	RS	R/W	E	DB0	DB1	DB2	DB3	DB4	DB5	DB6	DB7	LED(+)	LED(-)

