

# KV-M1410U/M1411U

## RM-694

## SERVICE MANUAL

*UK Model*  
 KV-M1410U  
 Chassis NO. SCC-D86K-A  
 KV-M1411U  
 Chassis NO. SCC-D86L-A

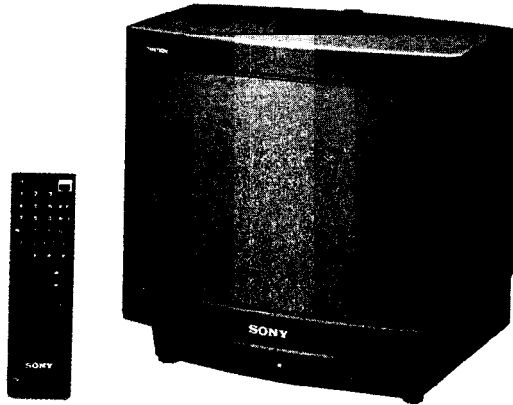

## BE-2A CHASSIS

For Service Manuals Contact  
 MAURITRON TECHNICAL SERVICES  
 8 Cherry Tree Rd, Chinnor  
 Oxon OX9 4QY  
 Tel: 01844-351694 Fax: 01844-352554  
 Email: enquiries@mauritron.co.uk

### MODELS OF THE SAME SERIES

KV-M1410U/M1411U	KV-M1921U
KV-M1420U/M1421U	KV-M2140U/M2141U
KV-M1620U/M1621U	

### SPECIFICATIONS

#### [KV-M1410U/M1411U]

Television system	I
Colour system	PAL
Channel coverage	UHF : 21-69
Picture tube	Black Trinitron tube 90° degree deflection Approx. 36.8 cm (14 inches) (Approx. 33.7cm picture measured diagonally)
Inputs	21-pin connector : CENELEC standard. Including RGB input Audio/Video input jacks : phono jacks
Outputs	21-pin connector : CENELEC standard Headphones jack : minijack
Sound output	5 W (Music)
Power consumption	64W (KV-M1410U) 69W (KV-M1411U)
Dimensions	Approx. 345x325x407.5mm (w/h/d)
Weight	Approx. 10.5kg (KV-M1410U) Approx. 11.0kg (KV-M1411U)

Supplied accessories	RM-694 Remote Commander (1) IEC designation R6 batteries (2) Loop antenna (1)
----------------------	---

#### [RM-694]

Remote control system	infrared control
Power requirements	3V dc 2 batteries IEC designation R6 (size AA)
Dimensions	Approx. 55×18×185mm (w/h/d)
Weight	Approx. 100g including batteries
Accessories supplied	IEC designation R6 batters (2)

Design and specifications are subject to change without notice.

TRINITRON® COLOUR TV  
**SONY®**



## 21-pin Euro Connector Configuration

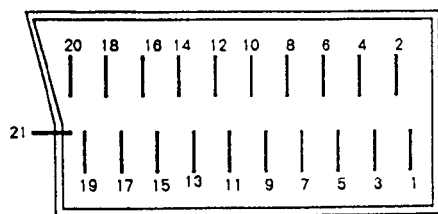

• **CAUTION**

The flexible mains lead is supplied connected to a B.S. 1363 fused plug having a fuse of 5 amp capacity. Should the fuse need to be replaced, use a 5 AMP FUSE approved by ASTA to BS 1362, i.e., carries the  mark.

**How to replace the fuse**

Open the fuse compartment with the blade screwdriver, and replace the fuse.

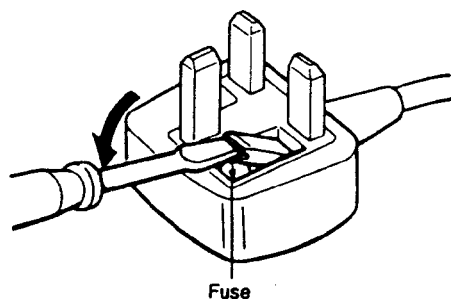

PIN	SIGNAL	SPECIFICATION
1	Audio output	0.5Vrms/1kilohm or less
2	Audio input	0.5Vrms/10kilohms or more
3	Audio output	0.5Vrms/1kilohm or less
4	Earth (audio)	
5	Earth (B-input)	
6	Audio input	0.5Vrms/10kilohms or more
7	B-input	0.7Vp-p/75ohms
8	Function switching	9.5V to 12V
9	Earth (G-input)	
10		
11	G-input	0.7Vp-p/75ohms
12		
13	Earth (R-input)	
14	Earth (blanking)	
15	R-input	0.7Vp-p/75ohms
16	Fast blanking	1V to 3V/75ohms
17	Earth (video)	
18	Earth (fast blanking)	
19	Video output	1Vp-p/75ohms
20	Video input	1Vp-p/75ohms
21	Screening plug	

**SAFETY-RELATED COMPONENT WARNING !!**

COMPONENTS IDENTIFIED BY SHADING AND MARK  ON THE SCHEMATIC DIAGRAMS, EXPLODED VIEWS AND IN THE PARTS LIST ARE CRITICAL TO SAFE OPERATION. REPLACE THESE COMPONENTS WITH SONY PARTS WHOSE PART NUMBERS APPEAR AS SHOWN IN THIS MANUAL OR IN SUPPLEMENTS PUBLISHED BY SONY.

## TABLE OF CONTENTS

<u>Section</u>	<u>Title</u>	<u>Page</u>
<b>1. GENERAL</b>		
1-1.	Index of the Parts .....	4
1-2.	To Preset Cannels .....	5
1-3.	Daily Use of the TV .....	5
1-4.	Picture and Sound Adjustment .....	6
1-5.	Viewing Teletext .....	6
<b>2. DISASSEMBLY</b>		
2-1.	Rear Cover Removal .....	7
2-2.	V Board Removal .....	7
2-3.	Service Position .....	7
2-4.	Picture Tube Removal .....	8
<b>3. SET-UP ADJUSTMENTS</b>		
3-1.	Beam Landing .....	9
3-2.	Convergence .....	10
3-3.	Focus .....	11
3-4.	Screen (G-2) and White Barance .....	12
<b>4. CIRCUIT ADJUSTMENTS</b>		
4-1.	A Board Adjustments .....	12
4-2.	V Board Adjustments .....	13
<b>5. DIAGRAMS</b>		
5-1.	Circuit Boards Location .....	14
5-2.	Schematic Diagrams and Printed Wiring Boards ..	15
5-3.	Semiconductors .....	24
<b>6. EXPLODED VIEW .....</b>		
		26
<b>7. ELECTRICAL PARTS LIST .....</b>		
		27

For Service Manuals Contact  
**MAURITRON TECHNICAL SERVICES**  
 8 Cherry Tree Rd, Chinnor  
 Oxon OX9 4QY  
 Tel:- 01844-351694 Fax:- 01844-352554  
 Email:- enquires@mauritron.co.uk

# SECTION 1 GENERAL

TV set

Note) The layout, etc., will be slightly different from the operating instructions packed with the units.

## 1-1. INDEX OF THE PARTS

In the following you will find a short description of the parts and their function on the set or on the remote commander using the respective symbols. For more details refer to the page number given in the index.

TV set

Front

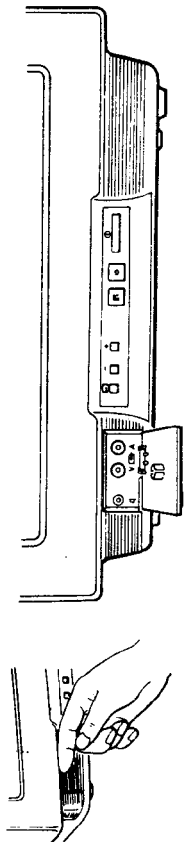

Pull to open the panel

Rear

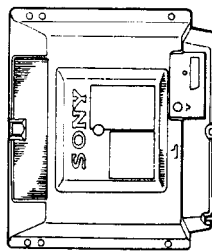

Remote Commander

Remote Commander

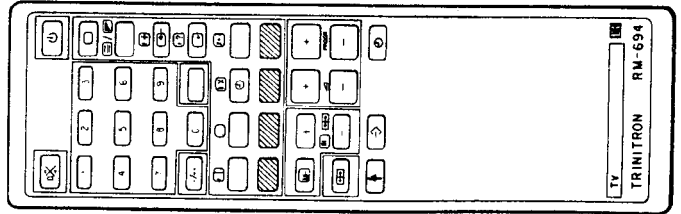

Symbol	Function
	Headphones jack (mini-jack)
	Video input jack
	Audio input jack
	Buttons for Sound and picture adjustment
	Programme scanning buttons
	Remote control detector
	Standby indicator
	Power switch
	Aerial socket (rear of the set)
	21-Pin connector (rear of the set)

Symbol	Function
	Mute button
1-9, 0, -/---	Number buttons — in case of two digit numbers first press button —/— and then two number buttons
	Button has no function
	Select button for picture adjustment item
	Buttons for adjustment picture items
	Buttons for manual fine tuning of a channel
	Button for resetting the picture adjustment items to standard
	Button for clearing a programme position (in preset mode)
	Functions only in combination with other buttons
	Preset mode on/off buttons
	Buttons for switching the TV set into standby mode
	Used to return to TV-mode from standby and video input modes
	Button for selecting the video input mode
	On/off button for onscreen display
	Time feature (only for KV-M1421U)
	Programme scanning buttons
	Buttons for adjusting the volume
	Button for activating the sleep timer
Note	Buttons not referred to in this index have no function.

## 1-2. TO PRESET CHANNELS

The control buttons to preset channels are located on the Remote Commander. (Up to 60 programme positions are at your disposal.)

- 1 Press the power switch on the set to switch it on.
- 2 Press both the **⇧** (shift) button and the **⇨** (preset) button simultaneously. You are now in the preset mode.
- 3 Use either button **PROGR +** (upwards) or **PROGR -** (downwards) to select the required programme position.
- 4 Press both the **⇧** button and the **⇨** or **⇩** button repeatedly until the desired TV station is found.
- 5 Repeat steps 3 and 4 for all other channels.
- 6 Press once more both the **⇧** button and the **⇨** (preset) button in order to return to the TV mode and to store the channels.

### Skipping of programme positions

Using both the button **C** and the **⇧** button you have the possibility to skip unused programme positions (e.g. without a stored station) when pressing the **PROGR +/-** buttons.

- 1 Press both the **⇧** button and the **⇨** (preset) button to select the preset mode.
- 2 Select the programme position to be skipped by pressing the **+** or **-** **PROGR** button.
- 3 Press the **C** button.
- 4 Press both the **⇨** (preset) button and the **⇧** button to return to the TV mode.

### Manual Fine Tuning

If the reception of a channel is not satisfactory you have the possibility to deactivate the Automatic Fine Tuning which usually tunes in the best possible picture during presetting. Press both the **⇧** button and the **⇨** or **⇩** button to fine tune the channel. By pressing the respective programme number the automatic Fine Tuning will be restored.

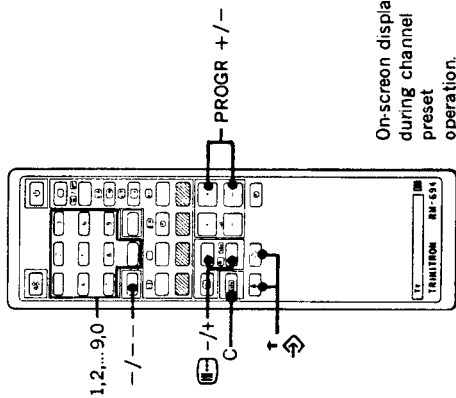

On-screen display during channel preset operation.

Programme position flashes.

Indicates the approximate location in the band of the channel being tuned in.

Programme number stops flashing.

On-screen display after presetting.

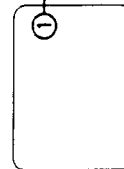
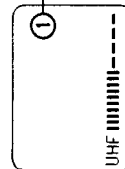
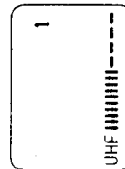
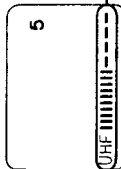

## 1-3. DAILY USE OF THE TV

Your TV set is supposed to be operated with the Remote Commander, for the basic functions however it is also possible to use the buttons on the set itself.

- **Switching the set on**  
Press the power switch on the set to switch the TV on, if the set is switched on, the green indicator on the set lights up, if it is in standby mode the red indicator lights up (see also 'Standby mode').
- **Switching the set off**  
Press the power switch on the set to switch the TV off.
- **Selection of programmes**  
Press the respective number button 1, 2, ..., 9 on the remote commander.  
In the case of two digit numbers, first press button **- / -** and then the two respective number buttons.  
With the **PROGR +/-** buttons you can scan the programme positions (**+** upwards, **-** downwards).
- **On the Set**  
Press the **-** button for lower programme positions and the **+** button for higher ones.
- **Standby mode**  
There are two possibilities to put the set into standby mode.

### 1. Directly

Press the button **⏻** on the remote commander. The red indicator **Ⓛ** on the set lights up.

### Note :

Use the standby button only for short breaks. If the set will not be used for a longer time span, use the power switch **⏻** to switch the set off.

### 2. By using the sleep timer

Press the **⌚** button repeatedly until the required time period is displayed on the screen (30, 60, 90 or 0 for cancelling of the operation).

In this way you can select the time period after which the set switches itself automatically into standby mode.

### Switching the set on out of standby mode

Press the **⏻** button or one of the number buttons on the remote commander.

### • On-screen display

Press the **Ⓛ** button to display the programme number on the screen and press the button once more to make (only for KV.M1421U) it disappear.

### • Time feature

In TV mode, if teletext is broadcast on the selected channel, press the button **Ⓛ** to display the current time.

### • Selecting the signal of the connected device

Press the **Ⓛ** button to receive the signal of the device (e.g. a video recorder) connected at the **V** or **A** connectors or the 21-pin connector (rear of the set). Press the **Ⓛ** button to return to the TV mode.

For Service Manuals Contact  
MAURITRON TECHNICAL SERVICES  
8 Cherry Tree Rd, Chinnor  
Oxon OX9 4QY  
Tel:- 01844-351694 Fax:- 01844-352554  
Email:- enquires@mauritron.co.uk

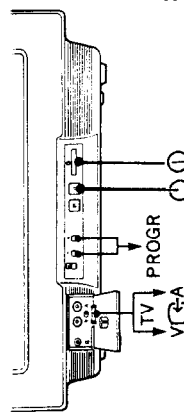

## 1-4. PICTURE AND SOUND ADJUSTMENTS

- Volume**  
 Press the button  $\triangle$  + to increase the volume and the button  $\nabla$  - to decrease it.
- On the set**  
 Press the button until  $\triangle$  is displayed on the screen and adjust the volume with the + or - button.
- Modification of the picture presettings**  
 Press the button on the commander to select either contrast  $\odot$ , colour intensity  $\odot$  or brightness  $\odot$  (the respective indication is displayed on the screen). Adjust the settings by pressing the + or - button.
- To return to factory-set levels**  
 Press the reset button  $\rightarrow \leftarrow$  to return to the preset picture levels.
- On the set**  
 Press the button in order to select the requested item (contrast  $\odot$ , colour intensity  $\odot$ , brightness  $\odot$ ), and adjust with the + or - button.
- Muting the sound**  
 Press the button to switch off the sound. Press the button again to restore the sound.

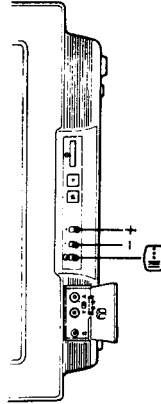
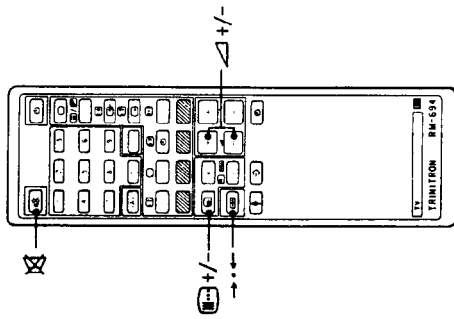

## 1-5. VIEWING TELETEXT (KV-M1411U only)

To view the teletext service, use the Remote Commander. RM-694 has teletext buttons indicated in green: teletext operation are indicated in green.

**Operation**

- Select the TV channel for the desired teletext service. Press  $\odot$  (TEXT/MIX) to display the teletext service.
- Once  $\odot$  has been pressed, the TV channel cannot be changed.
- Key in the three digits for the desired page using the number buttons. If an error is made, complete the three digit sequence by laying in any digit. Then re-enter the correct page number. The requested teletext page is displayed.

To return to the TV mode, press TV on the Remote Commander.

The teletext service can be displayed directly from the standby mode, by pressing  $\odot$ .

To receive the teletext service of a different TV channel:

- Press TV to return to the TV mode.
- Select the desired TV channel.
- Press  $\odot$ .

To enlarge the teletext display. Press  $\odot$ . Press once to enlarge the upper half of the display; press again to enlarge the lower half of the display; press again to return to the normal display.

To reveal concealed information such as the answers to a quiz Press  $\odot$  (REVEAL). Press again to conceal the answers.

To adjust the contrast of the teletext display. Press  $\odot$  + or - button.

To watch the TV program while waiting for a requested page to be displayed.

- Press  $\odot$  to watch the TV program. The requested page number appears at the top left of the screen. When the requested page has been found, the page number is displayed on the top left hand corner of the screen.



To view this page, press  $\odot$ .

To have a requested page displayed at a pre-determined time.

- Request a time coded page (e.g. alarm page). Press  $\odot$  (TP ON).
- "T\*\*\*\*" will appear at the bottom of the screen.



- Enter your request time with the number buttons, using four digits. For example, 07:30.



To watch the TV program until the requested time, press  $\odot$ . At the requested time, the page number will be displayed at the top of the screen. To view this page, press  $\odot$ . To cancel the request, first ensure that the teletext page is displayed, then press  $\odot$  (TP OFF).



To resume normal teletext reception, press  $\odot$ .

# SECTION 2 DISASSEMBLY

## 2-1. REAR COVER REMOVAL

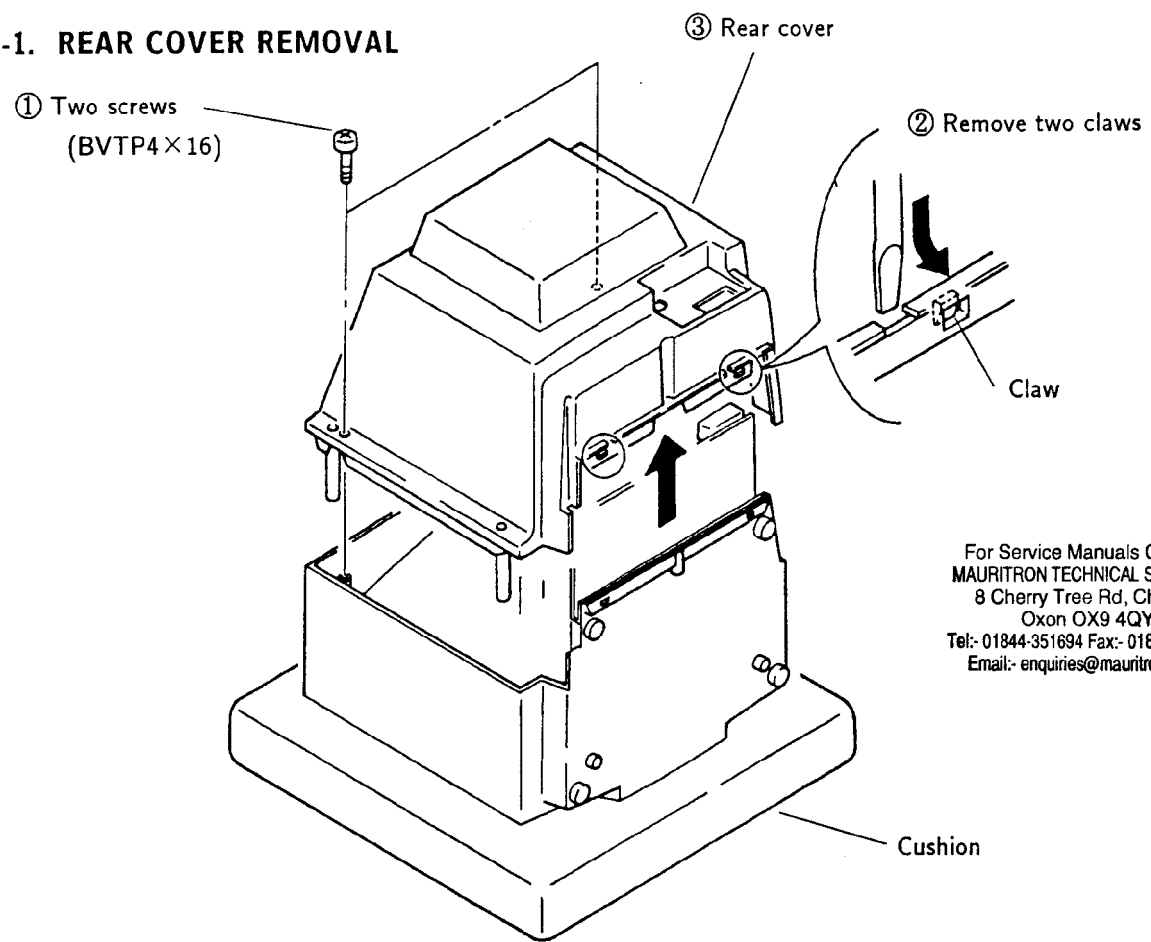

For Service Manuals Contact  
**MAURITRON TECHNICAL SERVICES**  
 8 Cherry Tree Rd, Chinnor  
 Oxon OX9 4QY  
 Tel: 01844-351694 Fax: 01844-352554  
 Email: enquiries@mauritron.co.uk

## 2-2. V BOARD REMOVAL

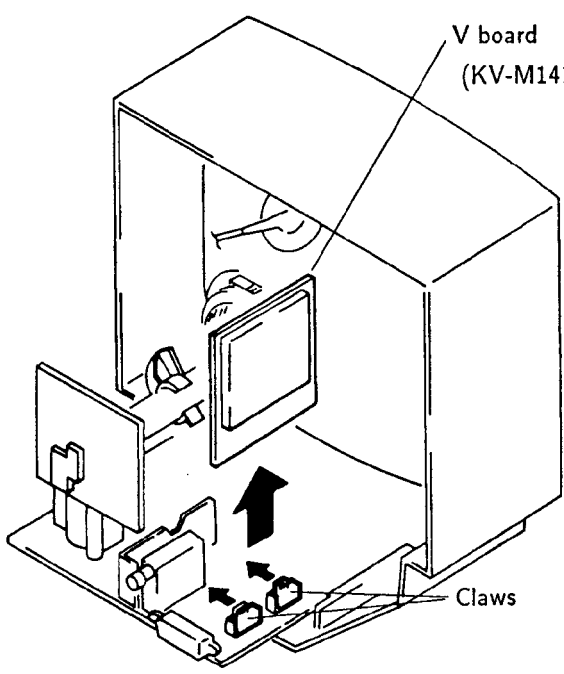

## 2-3. SERVICE POSITION

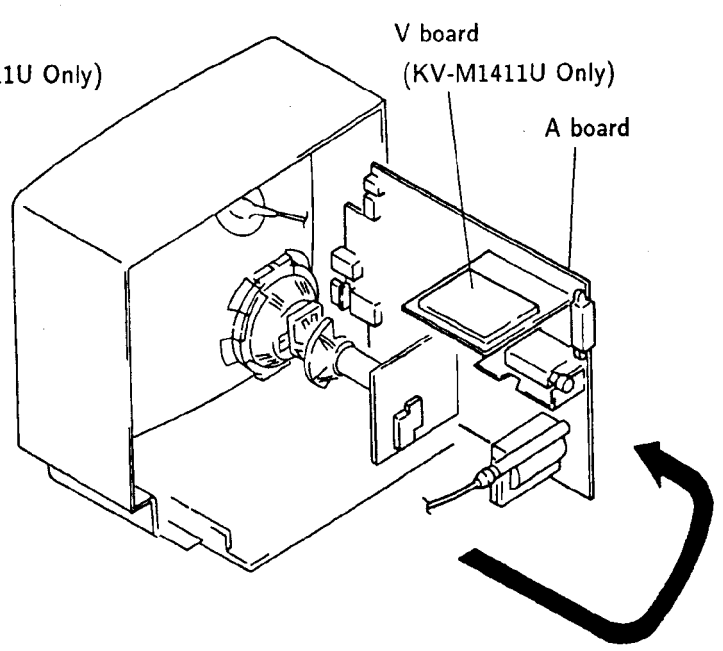

## 2-4. PICTURE TUBE REMOVAL

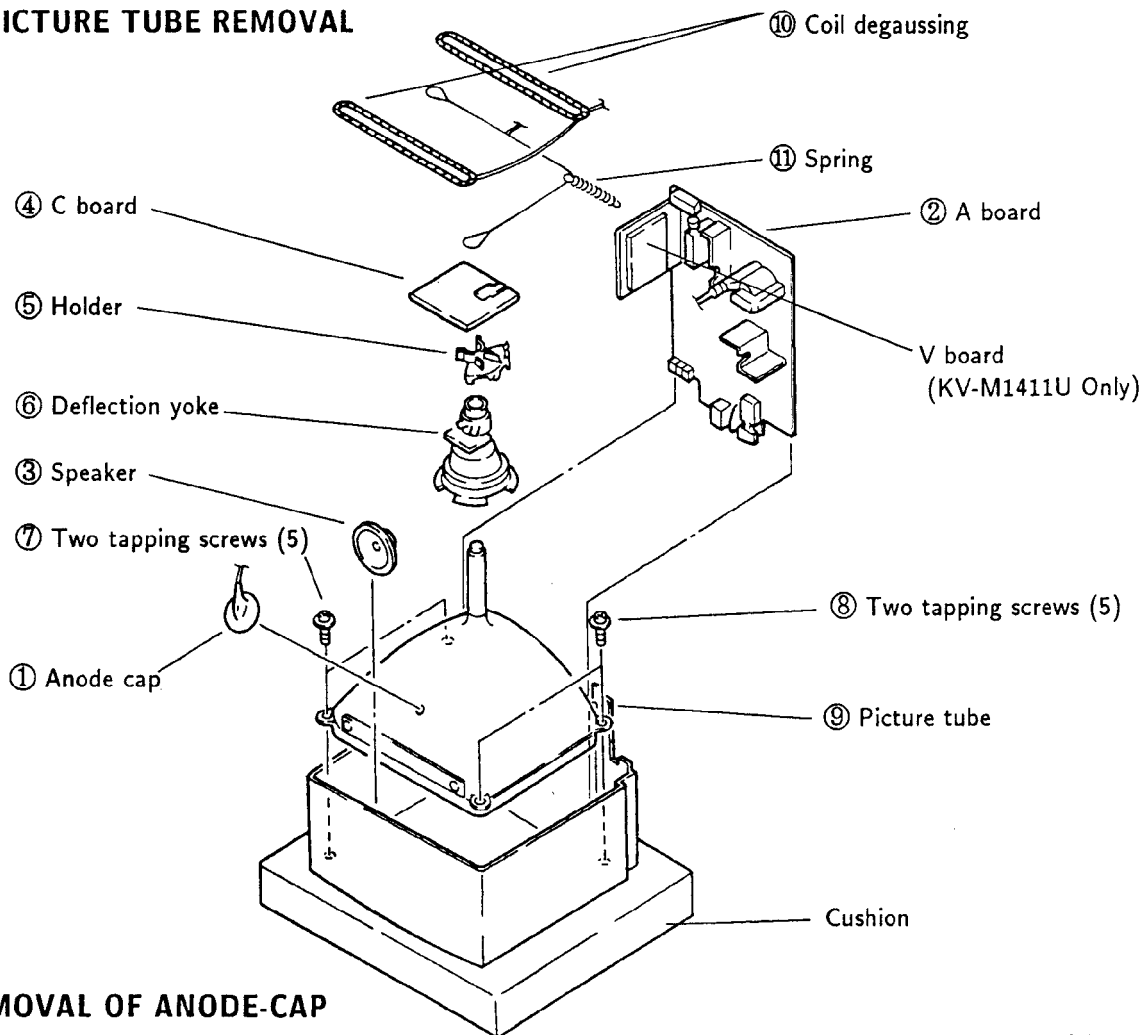

### • REMOVAL OF ANODE-CAP

NOTE : Short circuit the anode of the picture tube and the anode cap to the metal chassis, CRT shield or carbon painted on the CRT, after removing the anode.

#### • REMOVING PROCEDURES

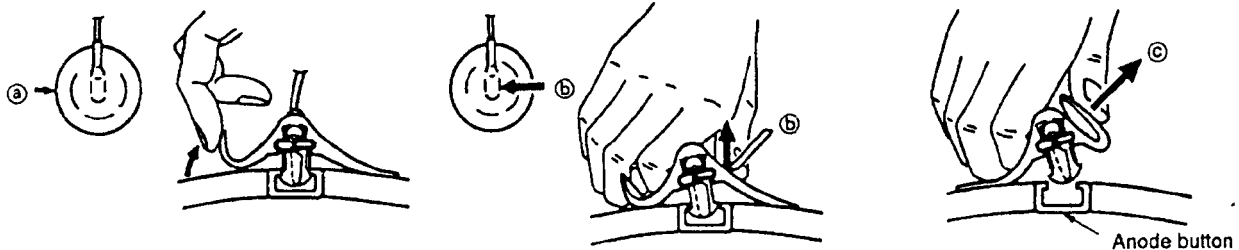

- ① Turn up one side of the rubber cap in the direction indicated by the arrow ③.
- ② Using a thumb pull up the rubber cap firmly in the direction indicated by the arrow ②.
- ③ When one side of the rubber cap is separated from the anode button, the anode-cap can be removed by turning up the rubber cap and pulling up it in the direction of the arrow ③.

#### • HOW TO HANDLE AN ANODE-CAP

- ① Don't hurt the surface of anode-caps with sharp shaped material!
- ② Don't press the rubber hardly not to hurt inside of anode-caps!  
A material fitting called as shatter-hook terminal is built in the rubber.
- ③ Don't turn the foot of rubber over hardly!  
The shatter-hook terminal will stick out or hurt the rubber.

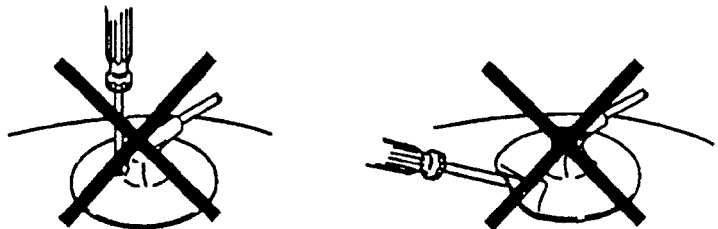



# SECTION 3 SET-UP ADJUSTMENTS

- The following adjustments should be made when a complete realignment is required or a new picture tube is installed.
  - These adjustments should be performed with rated power supply voltage unless otherwise noted.
- The controls and switch below should be set as follows unless otherwise noted :

- CONTRAST control..... 80%(or Normal by commander)
- ⊗ BRIGHTNESS control..... 50%

Perform the adjustments in order as follows:

### Preparation:

- Set the side of the unit with the PICTURE TUBE so that it faces east or west in order to reduce the influence of external magnetic force.
- Turn the power switch for the unit ON and erase the magnetic force using a degausser..

### 3-1. BEAM LANDING

Demagnetize with a degausser

1. Input a raster signal with the pattern generator.
 

CONTRAST	} normal
BRIGHTNESS	
2. Turn the raster signal of the pattern generator to red.
3. Move the deflection yoke backward, and adjust with the purity control so that red is in the center and blue and green are at the sides evenly. (Fig.3-1 - 3-3)
4. Move the deflection yoke forward, and adjust so that the entire screen becomes red. (Fig.3-1)
5. Switch over the raster signal to blue and blue and confirm the condition.
6. When the position of the deflection yoke is determined,tighten it with a deflection yoke mounting screw.
7. When landing at the corner is not right, adjust by using the disk magnets. (Fig.3-4)

1. Beam Landing
2. Convergence
3. Focus
4. Screen (G 2) and White Balance

**Note:** Test Equipment Required.

1. Color bar/Pattern Generator
2. Degausser
3. DC Power Supply
4. Digital multimeter
5. Oscilloscope

For Service Manuals Contact  
**MAURITRON TECHNICAL SERVICES**  
 8 Cherry Tree Rd, Chinnor  
 Oxon OX9 4QY  
 Tel:- 01844-351694 Fax:- 01844-352554  
 Email:- enquiries@mauritron.co.uk

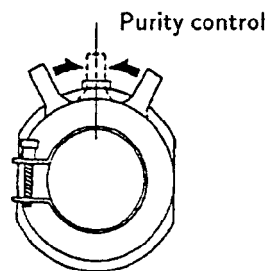

Fig.3-2

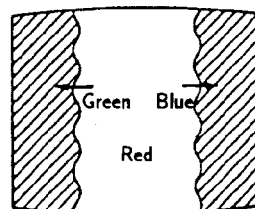

Fig.3-3

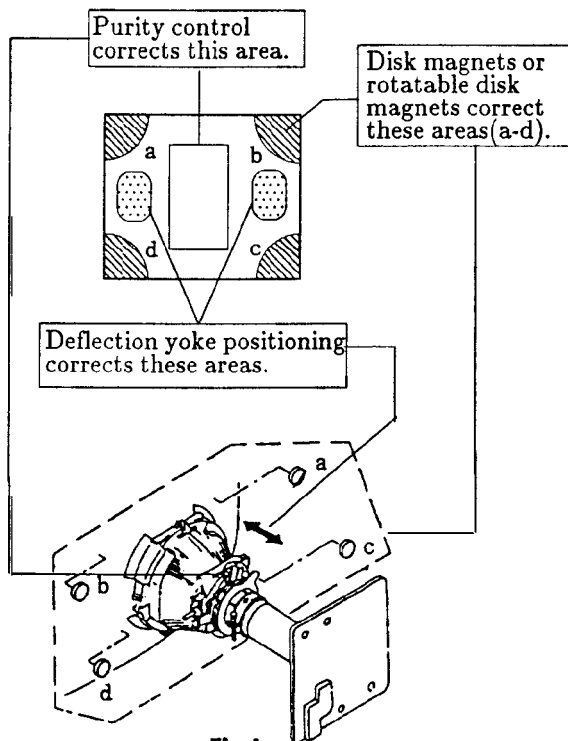

Fig.4

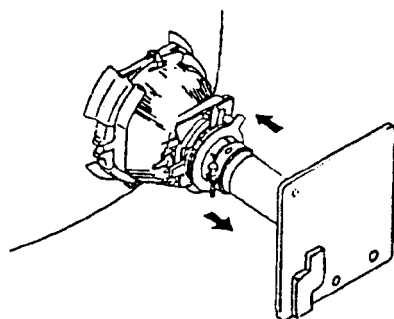

Fig.3-1

### 3-2. CONVERGENCE

**Preparation:**

- Before starting, perform FOCUS, H.SIZE, and V. SIZE adjustments.
- Set BRIGHTNESS control to minimum.
- Feed in the dot pattern.

**(1) Horizontal and Vertical Static Convergence**

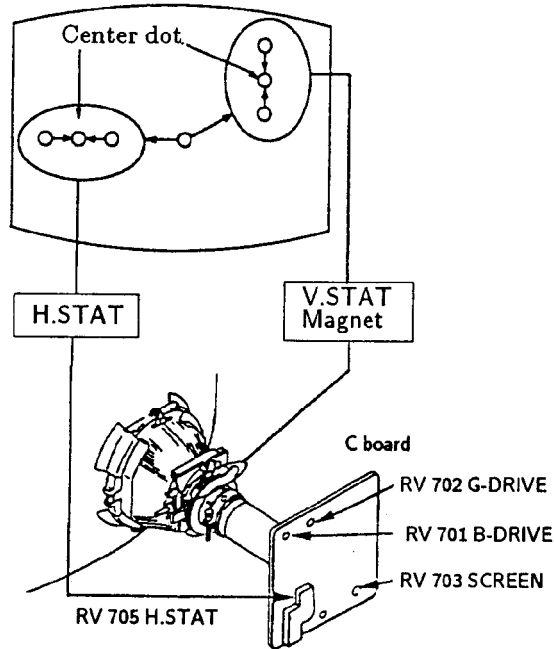

1. Adjust H.STAT VR to converge red, green and blue dots the in center of the screen.(Horizontal movement)
  2. Adjust V. STAT magnet to converge red, green and blue dots in the center of the screen. (Vertical movement)
  3. If the red, green and blue dots do not converge on the center of screen with H.STAT VR, perform horizontal convergence adjustment using H.STAT VR and V.STAT magnet as shown below. (In this case, H.STAT VR and V.STAT magnet effect each other.)
- Tilt the V.STAT magnet and adjust static convergence to open or close the V.STAT magnet.

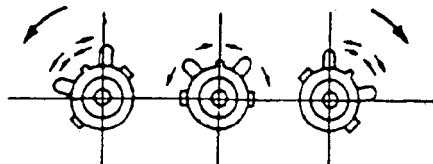

4. When the V.STAT magnet is moved in the direction of arrow (a) and (b), red, green and blue dots move as shown below.

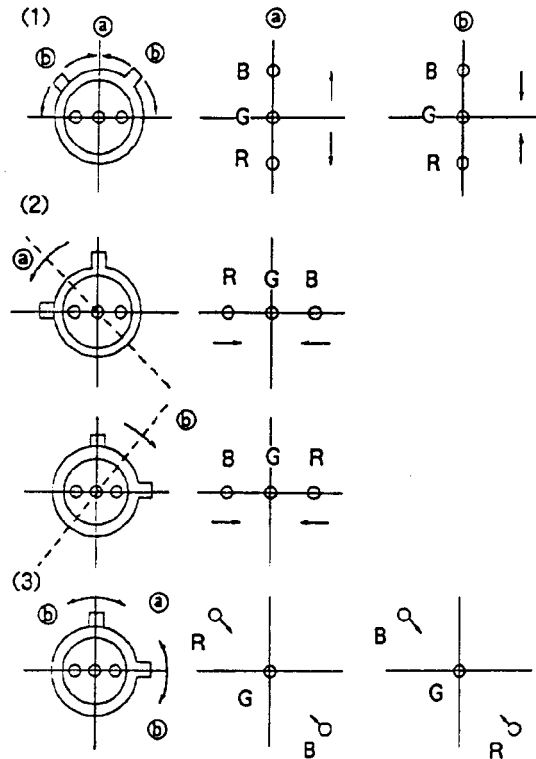

If the red and blue dot do not converge with green dots, perform following steps.

Move BMC magnet (a) to correct insufficient H.static convergence.

Rotate BMC magnet (b) to correct insufficient V.static convergence.

In either case, repeat Beam Landing Adjustment.

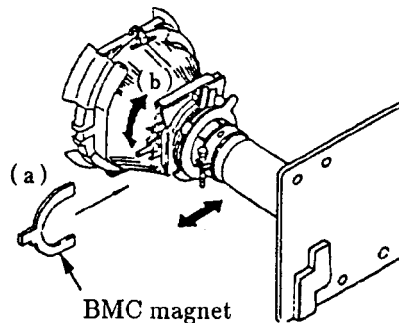

# SECTION 4 CIRCUIT ADJUSTMENTS

## (2) Dynamic Convergence Adjustment

### Preparation:

- Before starting perform Horizontal and Vertical static convergence Adjustment.

1. Slightly loosen deflection yoke screw.
2. Remove deflection yoke spacers.

3. Move the deflection yoke for best convergence as shown below.

4. Tighten the deflection yoke screw.
5. Install the deflection yoke spacers.

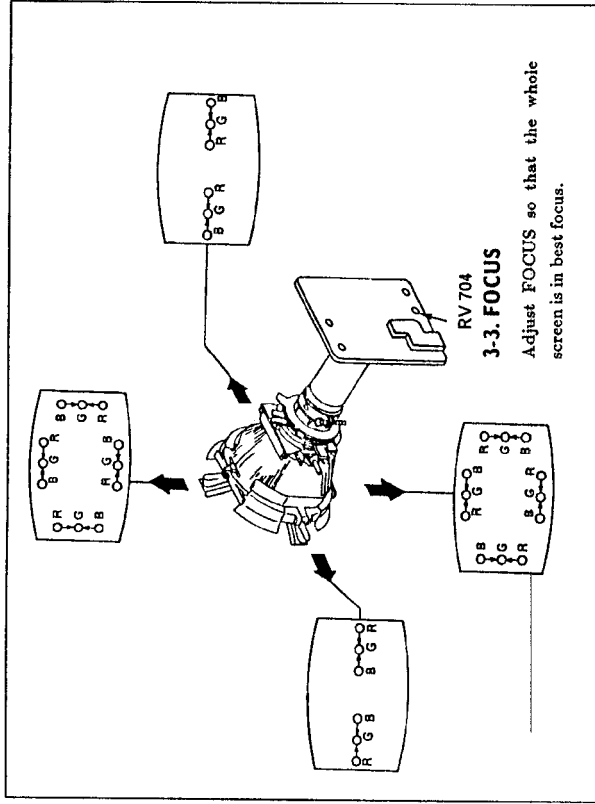

### 3-3. FOCUS

Adjust FOCUS so that the whole screen is in best focus.

## 3-4. SCREEN (G 2) and WHITE BALANCE

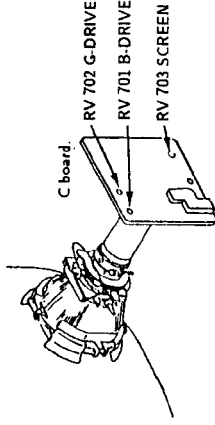

### Screen (G 2) Setting

1. Input dot signal from the pattern generator.
2. Set the picture BRIGHTNESS control to minimum level.
3. Apply 140 V DC to the cathodes of R, G and B from an external power power source.
4. While watching the picture, adjust the G 2 volume (RV703) immediately before fly-back line disappears.

### White Balance Adjustment

1. Input all-white signal from the pattern generator.
2. Adjust the BRIGHTNESS and COLOR controls to the standard level.
3. Adjust the following using RV 701 (B DRIVE) and RV 702 (G DRIVE)

In the following adjustments, the CONTRAST, COLOR and BRIGHTNESS controls are set to normal unless otherwise specified.

## (3) Screen-corner Convergence

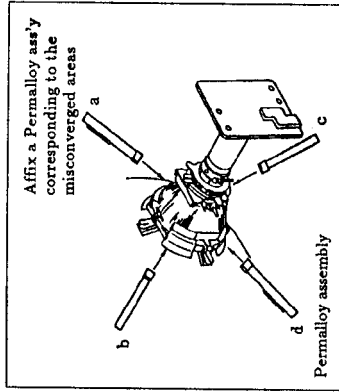
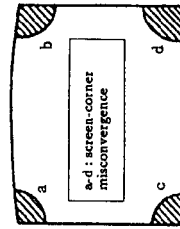

## 4-1. A BORAD ADJUSTMENTS

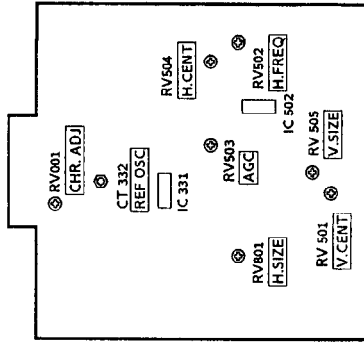

A BOARD  
-Component side-

### TU AGC Adjustment (RV 503)

1. Tune in air signal.
2. Adjust AGC VR (RV 503) so that snow-noise cross-modulation just disappear from the picture.

### RV 504 H.CENT (HORIZONTAL CENTER)

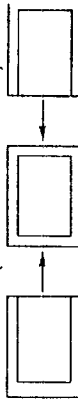

### RV 801 H.SIZE (HORIZONTAL SIZE)

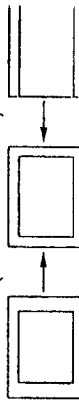

### RV 501 V.CENT (VERTICAL CENTER)

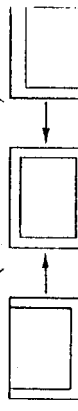

### RV 505 V.SIZE (VERTICAL SIZE)



For Service Manuals Contact  
MAURITRON TECHNICAL SERVICES  
8 Cherry Tree Rd, Chinnor  
Oxon OX9 4QY  
Tel: 01844-351694 Fax: 01844-352554  
Email: enquiries@mauritron.co.uk

**H.FREQ Adjustment (RV 502)**

1. Input a PAL COLOR BAR signal, then connect an electrolytic capacitor (100  $\mu$ /16 V) between pin ⑳ and GND of IC 502.
2. Adjust RV 502 (H.FREQ) to stop scrolling of the picture in the horizontal direction.
3. After adjustment, remove the electrolytic capacitor.

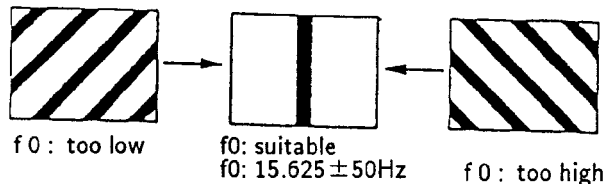

**REF OSC 8.8 MHz Adjustment (CT 332)**

1. Input a PAL COLOR BAR pattern.
2. Short circuit between pin ⑪ of IC 331 and ground.
3. Adjust CT 332 to obtain color synchronization.
4. Remove the jumper wire from IC 331.

**CHARACTER POSITION Adjustment (RV 001)**

d

1. Input PAL COLOR BAR pattern.
2. Adjust RV 001 to position the character display at the point indicated by the arrow below.

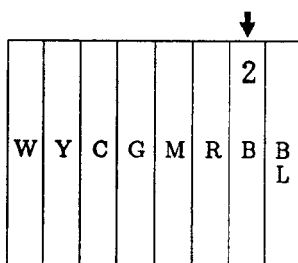

**4-2. V BOARD ADJUSTMENTS**

(KV-M 1411 U Only)

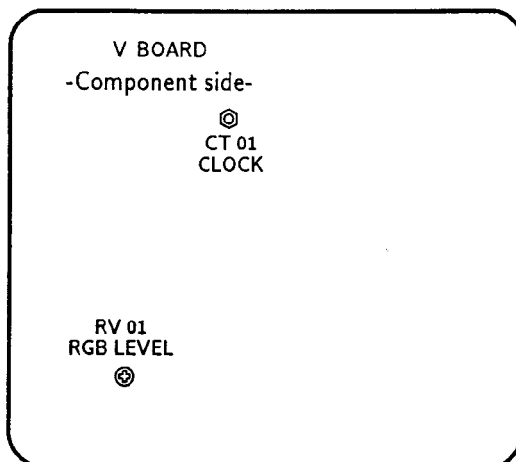

**Clock Adjustment (CT 01)**

1. Raies pin ③ of CNV 01.
2. Set up the TELETEXT mode.
3. Adjust CT 01 to stop the pictures from scrolling.

**RGB Level Adjustment (RV 01)**

1. Set PICTURE to maximum.
2. Adjust RV01 till the RGB output becomes maximum.

For Service Manuals Contact  
MAURITRON TECHNICAL SERVICES  
8 Cherry Tree Rd, Chinnor  
Oxon OX9 4QY  
Tel:- 01844-351694 Fax:- 01844-352554  
Email:- enquiries@mauritron.co.uk

# SECTION 5 DIAGRAMS

## 5-1. CIRCUIT BOARDS LOCATION

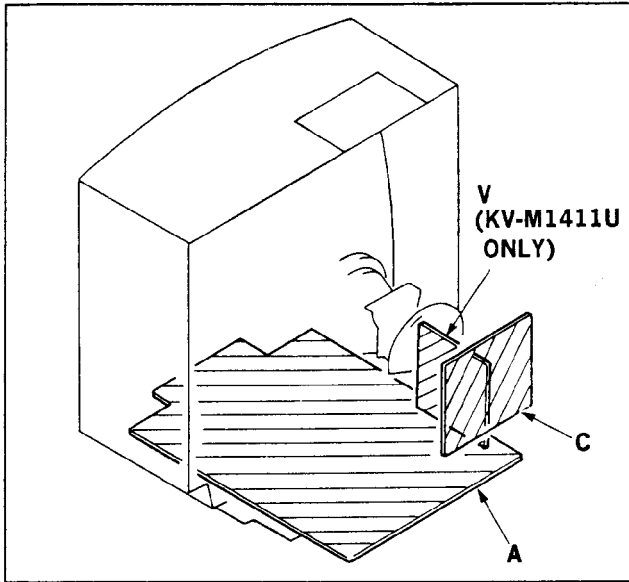

### Reference information

RESISTOR	: RN	METAL FILM
	: RC	SOLID
	: FPRD	NONFLAMMABLE CARBON
	: FUSE	NONFLAMMABLE FUSIBLE
	: RS	NONFLAMMABLE METAL OXIDE
	: RB	NONFLAMMABLE CEMENT
	: RW	NONFLAMMABLE WIREWOUND
	: *	ADJUSTMENT RESISTOR
COIL	: LF-BL	MICRO INDUCTOR
CAPACITOR	: TA	TANTALUM
	: PS	STYROL
	: PP	POLYPROPYLENE
	: PT	MYLAR
	: MPS	METALIZED POLYESTER
	: MPP	METALIZED POLYPROPYLENE
	: ALB	BIPOLAR
	: ALT	HIGH TEMPERATURE
	: ALR	HIGH RIPPLE

**Note:** The components identified by shading and mark are critical for safety. Replace only with part number specified.

### Note :

- All capacitors are in  $\mu\text{F}$  unless otherwise noted.  
 $\mu\text{F}$  :  $\mu\mu\text{F}$  50WV or less are not indicated except for electrolytics.
- Indication of resistance, which does not have one for rating electrical power, is as follows.

Pitch : 5mm Rating electrical power : 1/4W
---

- Chip resistor is in 1/10W.
- All resistors are in ohms.  $\text{k}\Omega = 1000\Omega$ ,  $\text{M}\Omega = 1000\text{k}\Omega$
- : nonflammable resistor.
- : fusible resistor.
- $\Delta$  : internal component.
- : panel designation and adjustment for repair.
- All variable and adjustable resistors have characteristic curve B, unless otherwise noted.
- All voltages are in V.
- Readings are taken with a  $10\text{M}\Omega$  digital multimeter.
- Readings are taken with a color-bar signal input.
- Voltage variations may be noted due to normal production tolerances.
- : B + line.
- : signal path.

Reference information

- RESISTOR : RN METAL FILM  
 : RC SOLID  
 : FPRD NONFLAMMABLE CARBON  
 : FUSE NONFLAMMABLE FUSIBLE  
 : RS NONFLAMMABLE METAL OXIDE  
 : RB NONFLAMMABLE CEMENT  
 : RW NONFLAMMABLE WIREWOUND  
 : \* ADJUSTMENT RESISTOR  
 COIL : LF-8L MICRO INDUCTOR  
 CAPACITOR : TA TANTALUM  
 : PS STYROL  
 : PP POLYPROPYLENE  
 : PT MYLAR  
 : MPS METALIZED POLYESTER  
 : MPP METALIZED POLYPROPYLENE  
 : ALB BIPOLAR  
 : ALT HIGH TEMPERATURE  
 : ALR HIGH RIPPLE

For Service Manuals Contact  
**MAURITRON TECHNICAL SERVICES**  
 8 Cherry Tree Rd, Chinnor  
 Oxon OX9 4QY  
 Tel: 01844-351694 Fax: 01844-352554  
 Email: enquiries@mauritron.co.uk

5-2. SCHEMATIC DIAGRAMS AND PRINTED WIRING BOARD

—A Board—

IC			
IC001	C-9	D306	B-6
IC002	D-9	D313	A-3
IC003	D-10	D321	C-5
IC004	E-9	D324	A-7
IC005	B-8	D402	A-1
IC102	B-5	D403	B-1
IC201	F-8	D404	B-1
IC301	D-5	D405	A-1
IC302	B-7	D406	C-1
IC331	C-6	D410	A-1
IC501	D-2	D411	A-1
IC502	C-3	D417	D-1
IC601	G-5	D418	A-4
IC801	E-3	D426	C-1
IC802	E-4	D501	D-3
		D503	E-4
		D504	G-2
		D519	C-8
		D601	F-7
		D602	F-6
		D603	F-5
		D604	E-4
		D605	E-6
		D606	D-5
		D607	G-5
		D608	G-5
		D609	G-5
		D610	G-5
		D611	F-4
		D801	G-3
		D802	G-4
		D803	G-4
		D805	G-1
		D806	F-1
		D807	F-3
		D808	E-3
		D810	E-1
		D811	E-1
		D820	F-4
TRANSISTOR		VARIABLE RESISTOR	
Q001	D-8	RV001	D-9
Q003	D-9	RV501	D-2
Q004	D-10	RV502	B-4
Q005	B-8	RV503	C-4
Q006	C-8	RV504	B-4
Q007	B-4	RV505	D-2
Q009	A-8	RV801	F-4
Q015	D-3		
Q016	D-10		
Q017	E-9		
Q019	D-10		
Q020	D-8		
Q104	B-1		
Q106	A-2		
Q107	A-2		
Q112	A-7		
Q114	B-5		
Q115	A-6		
Q123	A-2		
Q141	C-3		
Q302	C-7		
Q304	B-6		
Q305	B-6		
Q307	B-6		
Q310	A-3		
Q311	A-3		
Q401	B-1		
Q457	D-1		
Q504	C-3		
Q505	B-3		
Q601	G-5		
Q801	F-4		
Q802	G-3		
Q803	E-3		
DIODE		TRIMMER	
D002	E-10	CT332	C-7
D004	C-9		
D007	B-8		
D008	D-10		
D009	B-8		
D020	B-8		
D110	C-5		
D301	C-6		
D302	A-2		
D303	B-6		
D305	A-2		

—A Board—

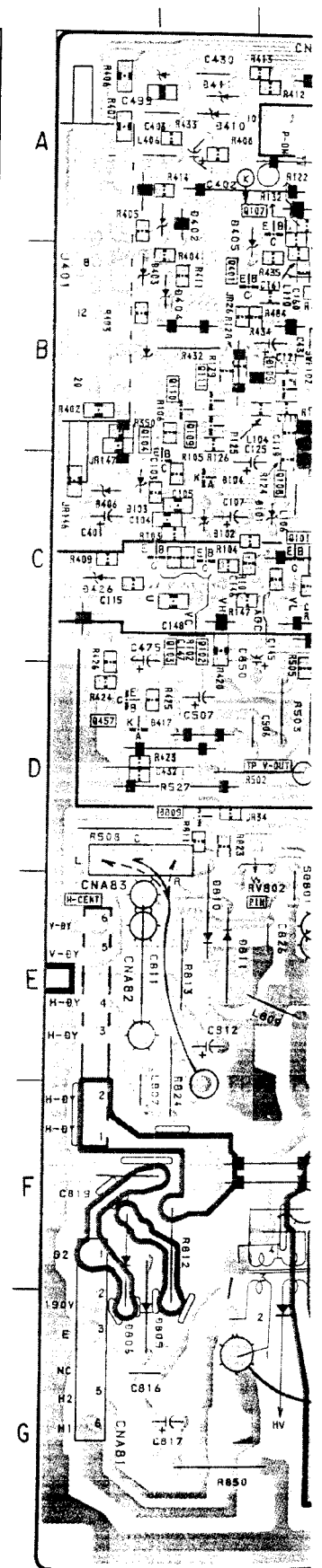

SYSTEM CONTROL, A/V OUT,  
H/V OUT, MEMORY, CHROMA

A

A

IC DIAGRAMS AND PRINTED WIRING BOARDS

- A Board -

D306	B.6
D313	A.3
D321	C.5
D324	A.7
D402	A.1
D403	B.1
D404	B.1
D405	A.1
D406	C.1
D410	A.1
D411	A.1
D417	D.1
D418	A.4
D426	C.1
D501	D.3
D503	E.4
D504	G.2
D519	C.8
D601	F.7
D602	F.6
D603	F.5
D604	E.4
D605	E.6
D606	D.5
D607	G.5
D608	G.5
D609	G.5
D610	G.5
D611	F.4
D801	G.3
D802	G.4
D803	G.4
D805	G.1
D806	F.1
D807	F.3
D808	E.3
D810	E.1
D811	E.1
D820	F.4

VARIABLE RESISTOR	
V001	D-9
V501	D-2
V502	B-4
V503	C-4
V504	B-4
V505	D-2
V801	F-4

TRIMMER	
T332	C-7

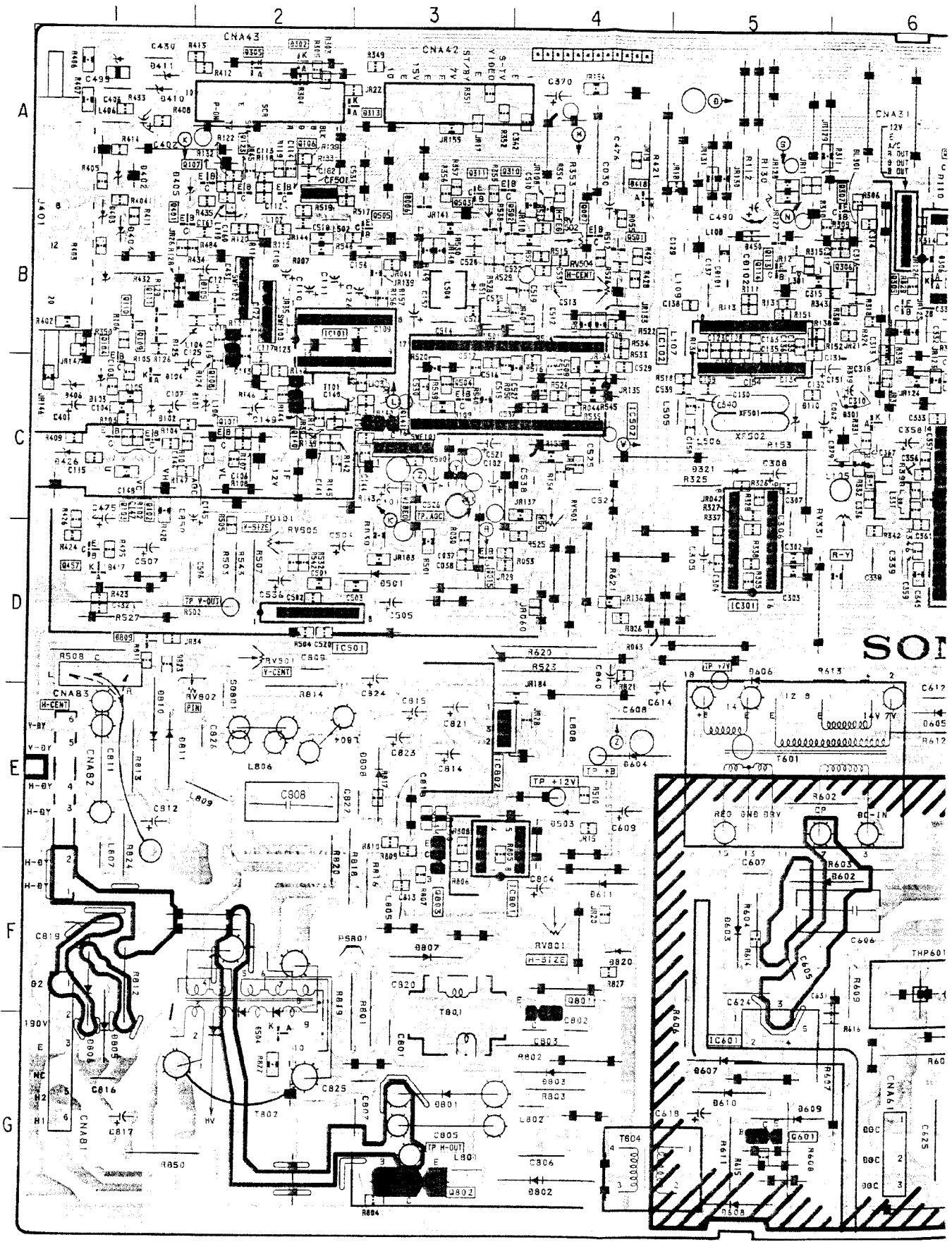

A



NOTE:

The circuit indicated as left contains high voltage of over 600 Vp-p. Care must be paid to prevent an electric shock in inspection or repairing.

4 5 6 7 8 9 10

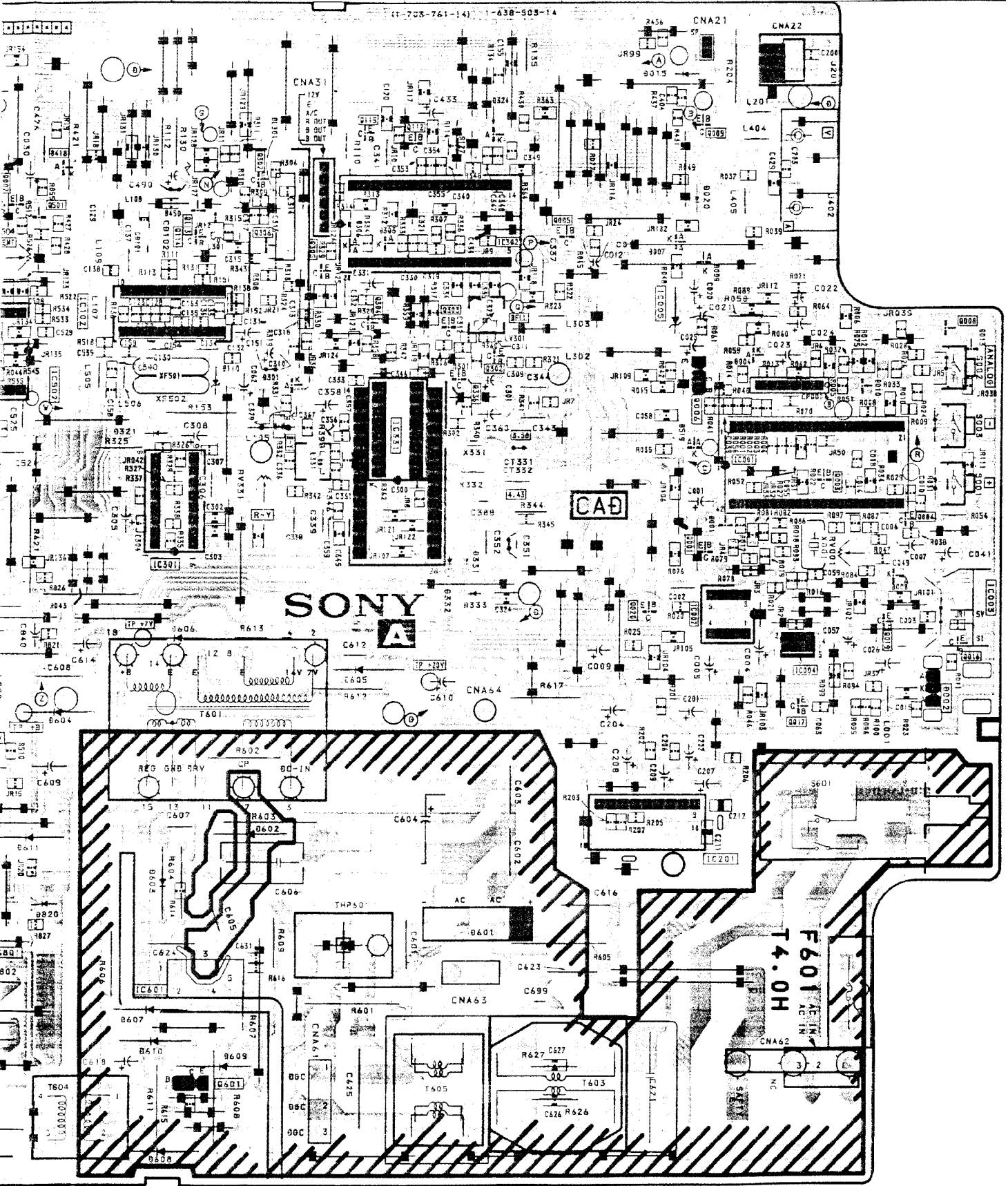

For Service Manuals Contact  
MAURITRON TECHNICAL SERVICES  
8 Cherry Tree Rd, Chinnor  
Oxon OX9 4QY  
Tel: 01844-351694 Fax: 01844-352554  
Email: enquiries@mauritron.co.uk



1 2 3 4 5 6 7 8

A  
B  
C  
D  
E  
F  
G  
H

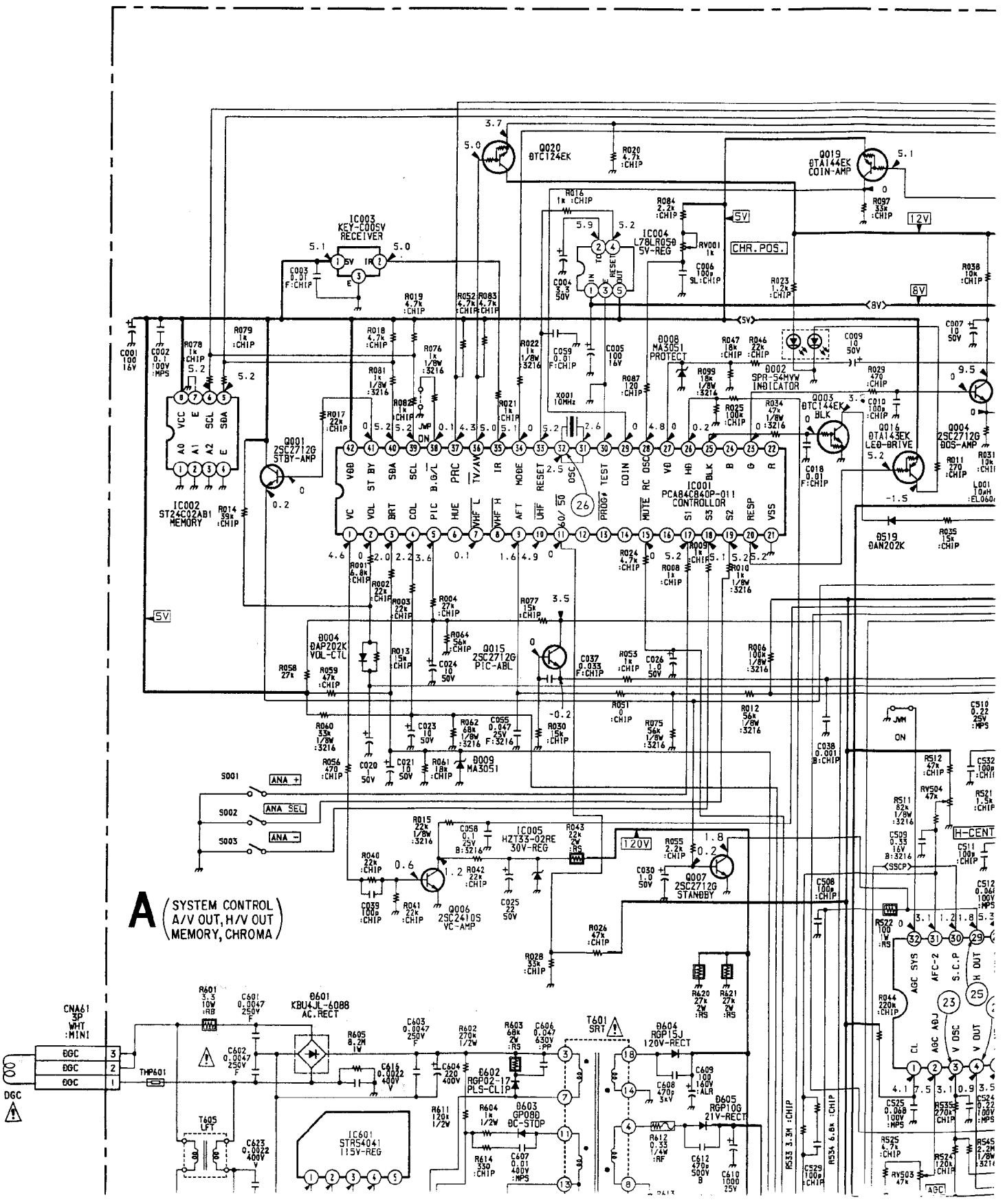

**A** (SYSTEM CONTROL)  
 (A/V OUT, H/V OUT)  
 MEMORY, CHROMA

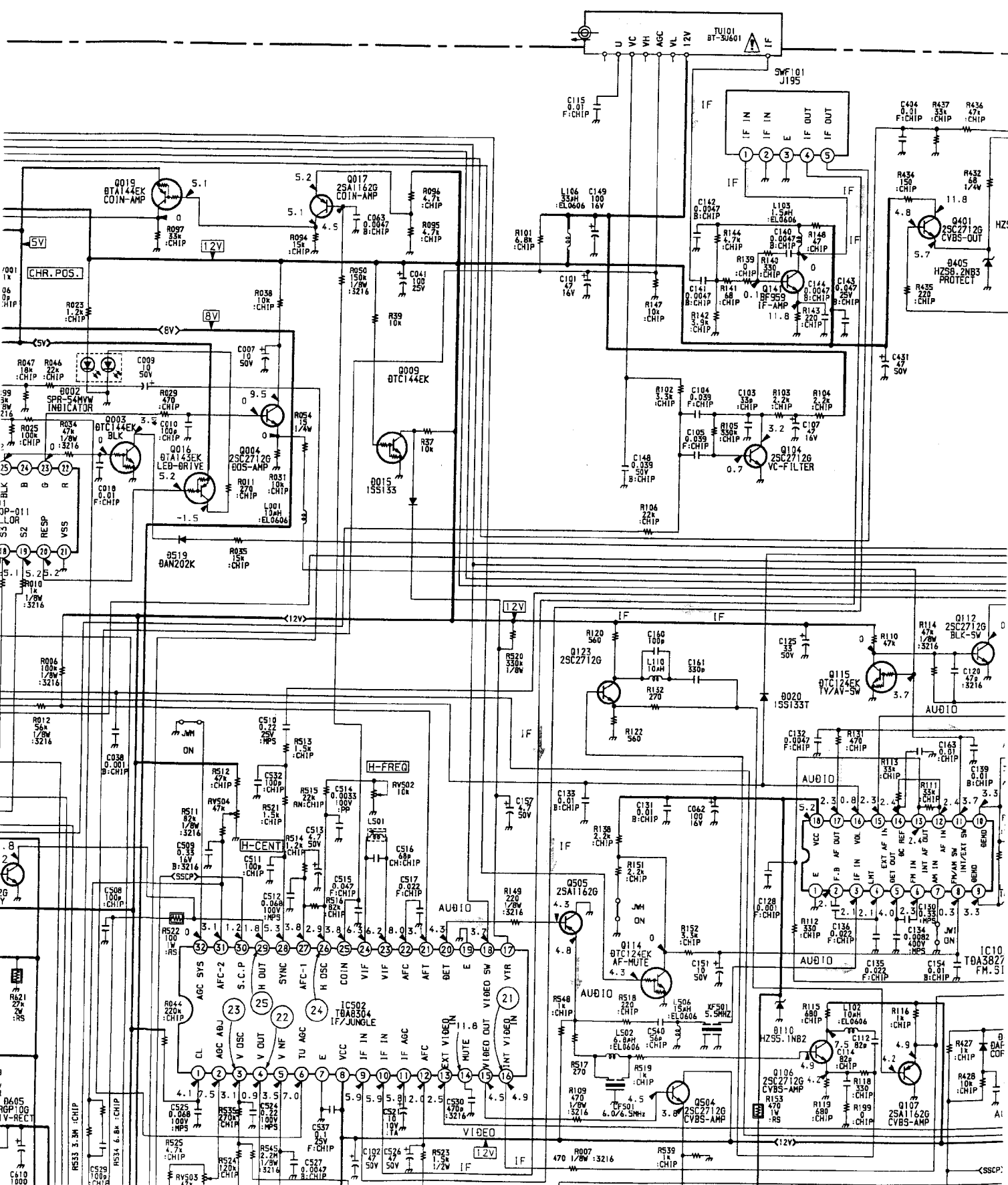

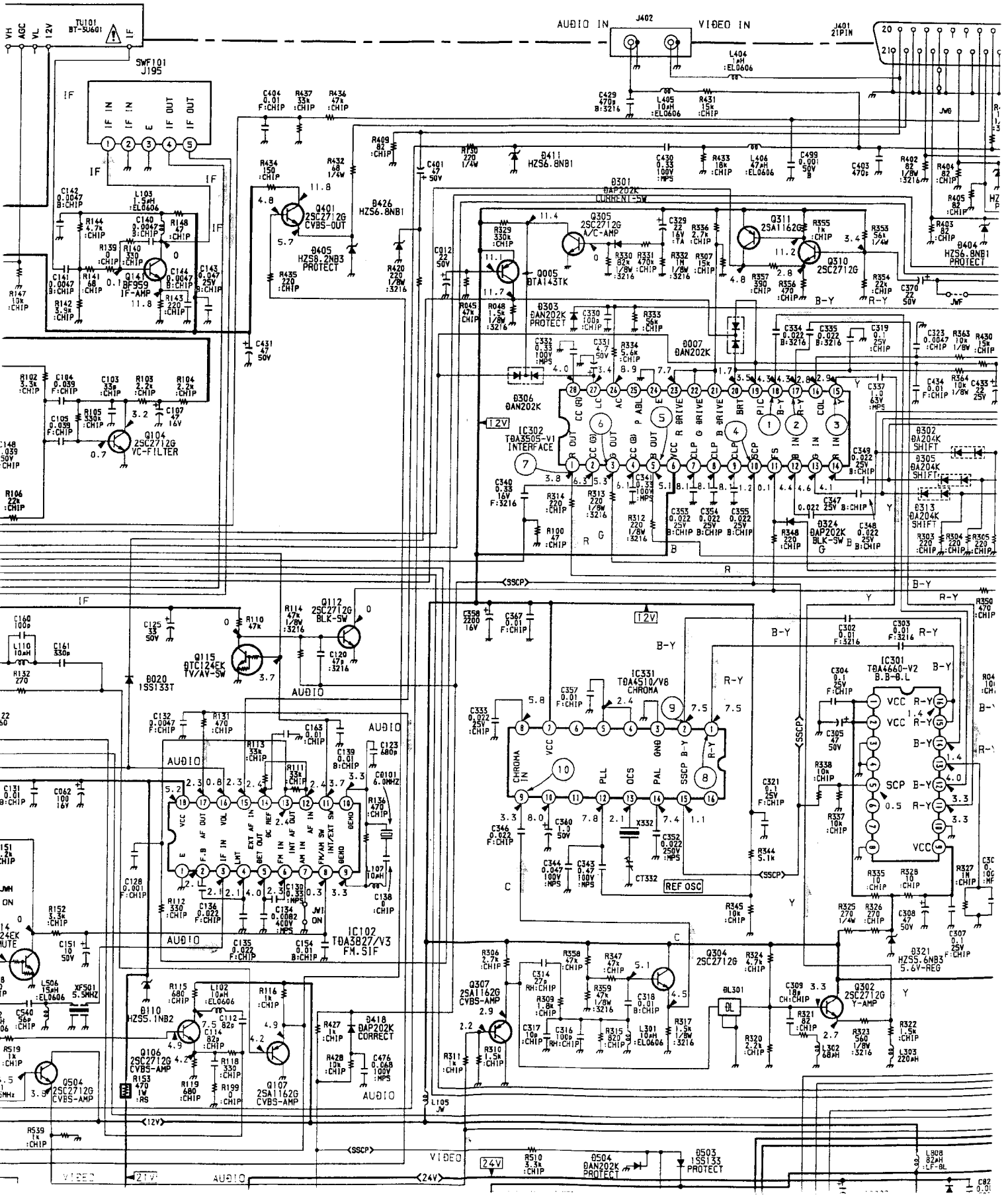

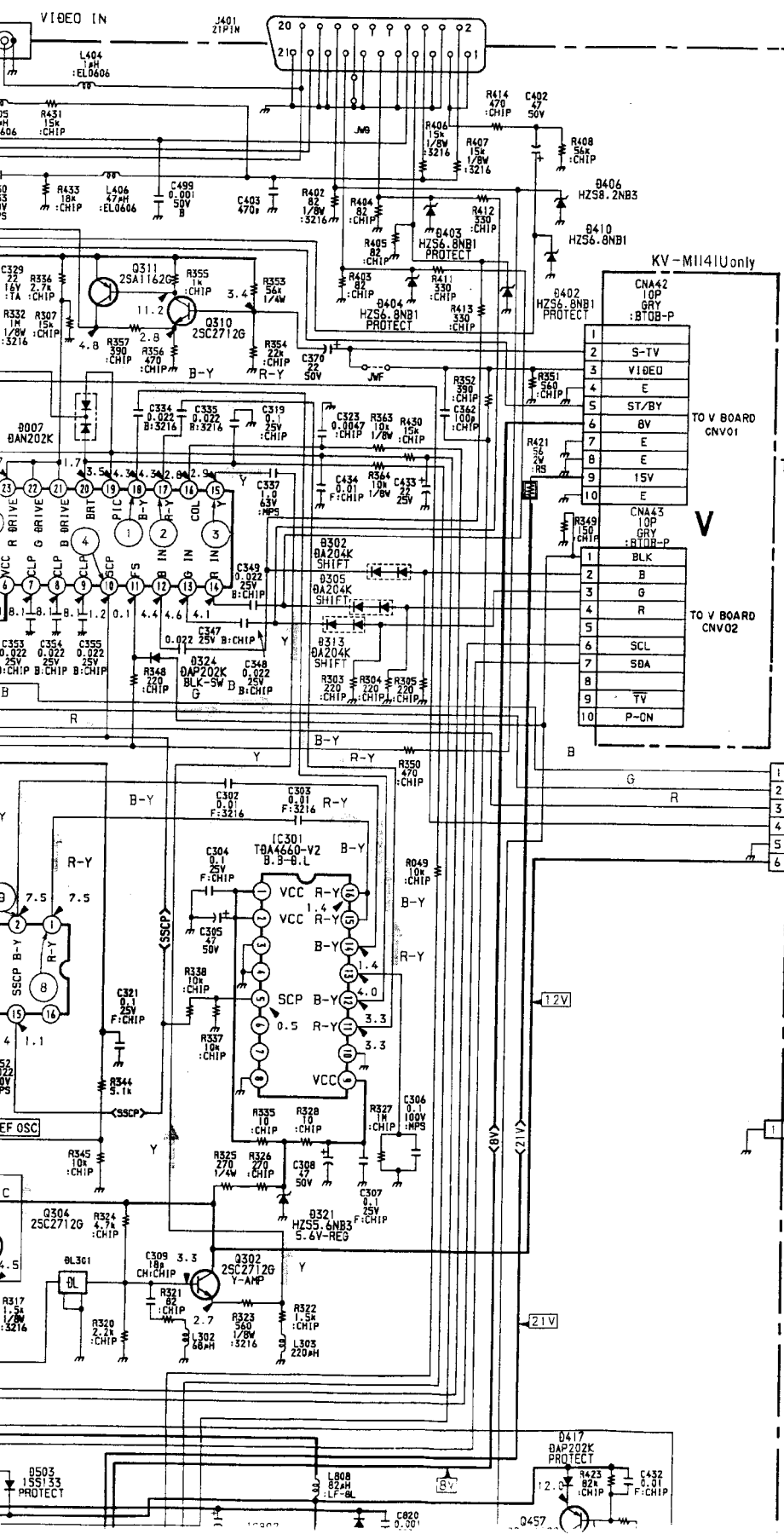

For Service Manuals Contact  
**MAURITRON TECHNICAL SERVICES**  
 8 Cherry Tree Rd, Chinnor  
 Oxon OX9 4QY  
 Tel: 01844-351694 Fax: 01844-352554  
 Email: enquiries@mauritron.co.uk

**A BOARD IC331 TDA4**

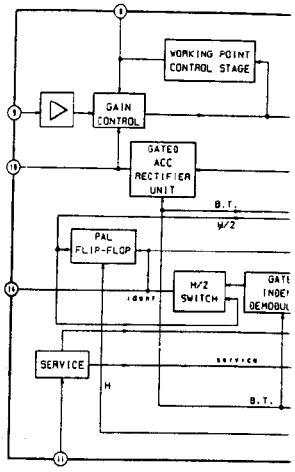

**A BOARD IC302 TDA35**

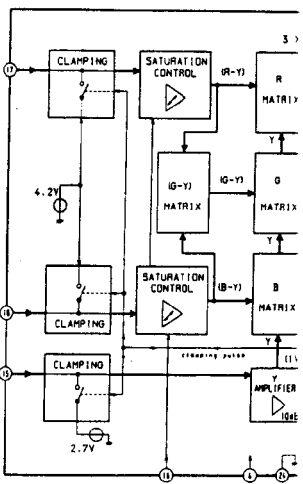

**• A Board**

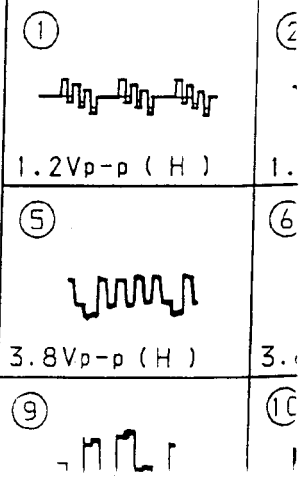

**A BOARD IC331 TDA4510/V8**

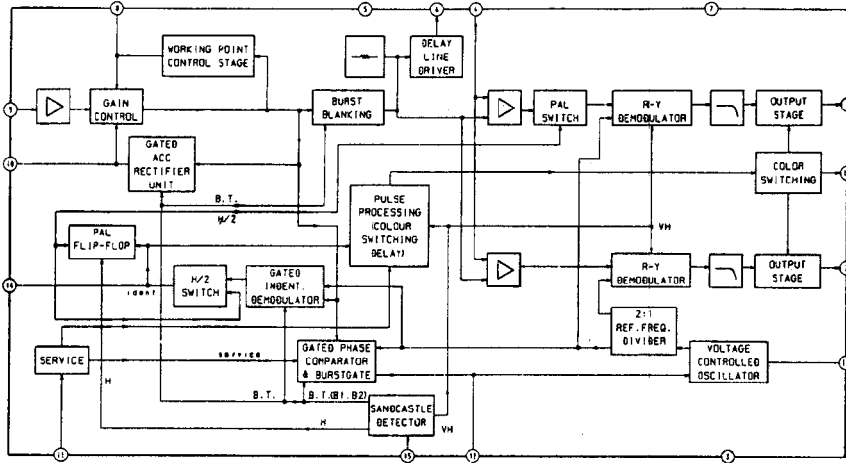

**A BOARD IC302 TDA3505-V1**

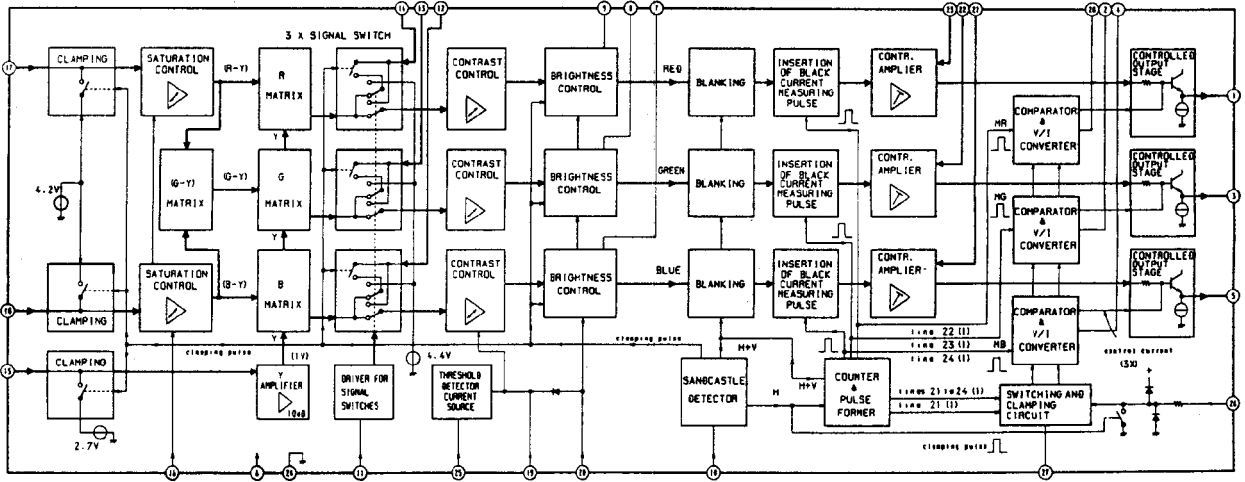

**• A Board**

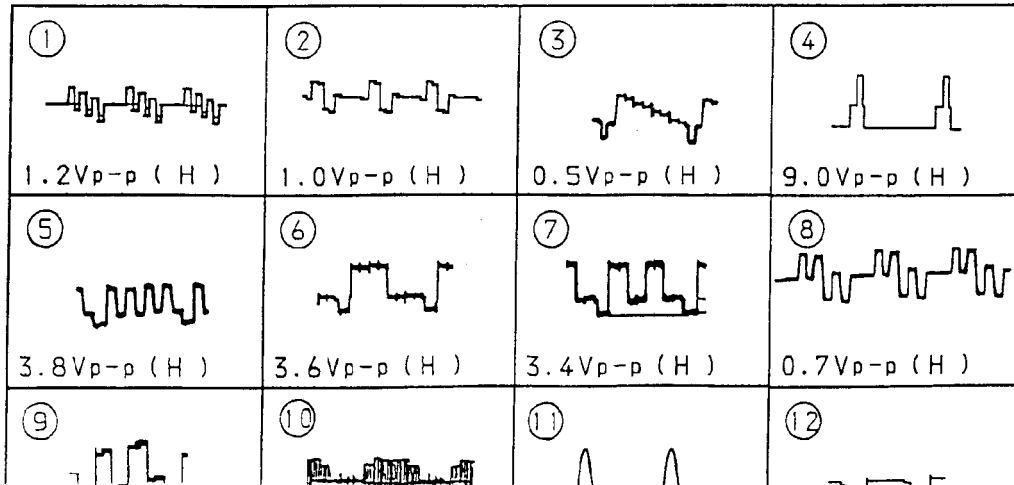

TO COATING E

D  
E  
F  
G  
H  
I  
J  
K  
L  
M  
N

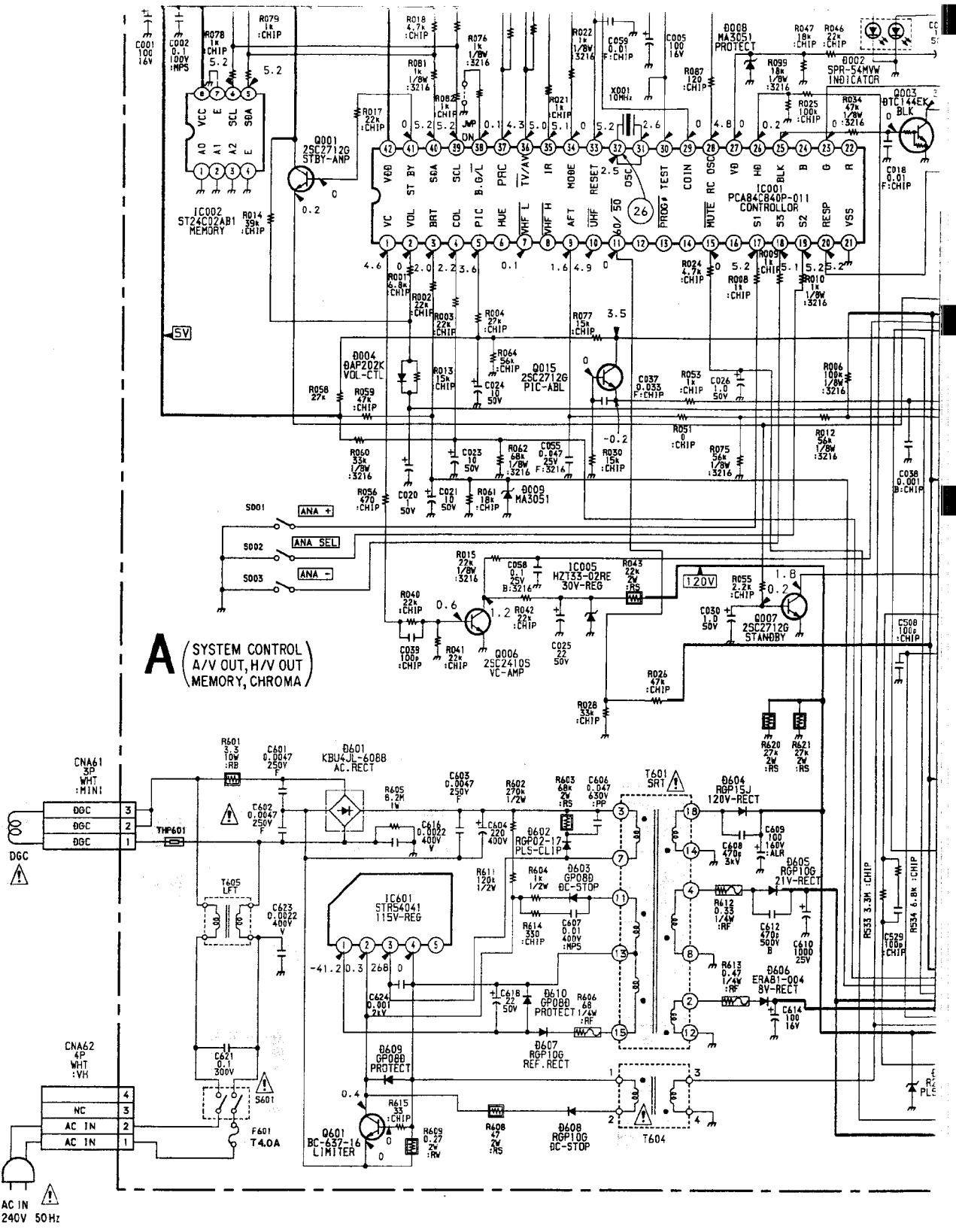







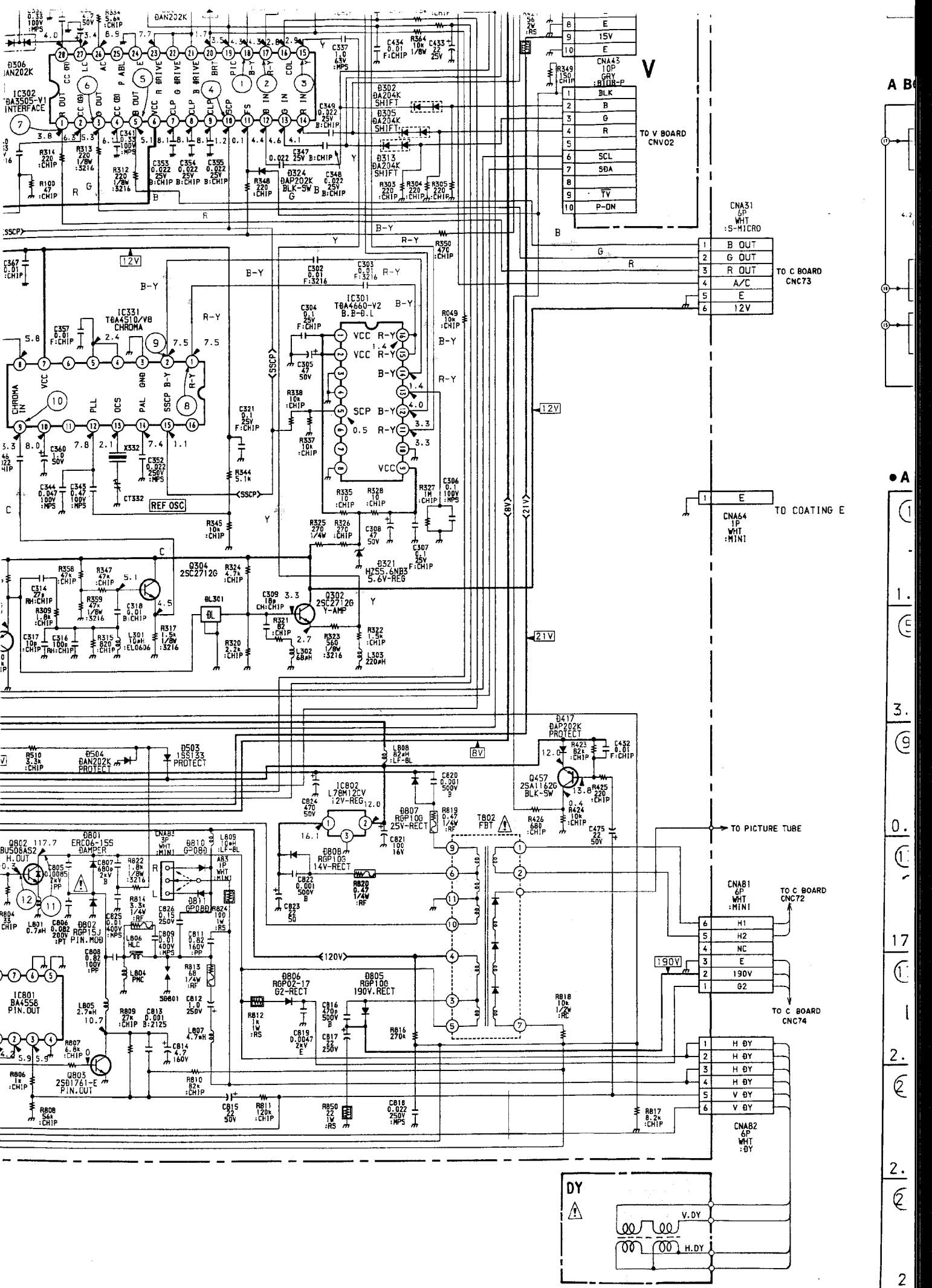

A B

1. (E)

3. (E)

9. (E)

0. (E)

17. (E)

1. (E)

2. (E)

2. (E)

2. (E)

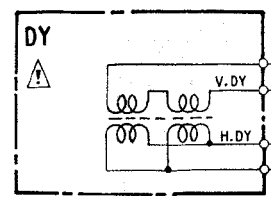

**A BOARD IC302 TDA3505-V1**

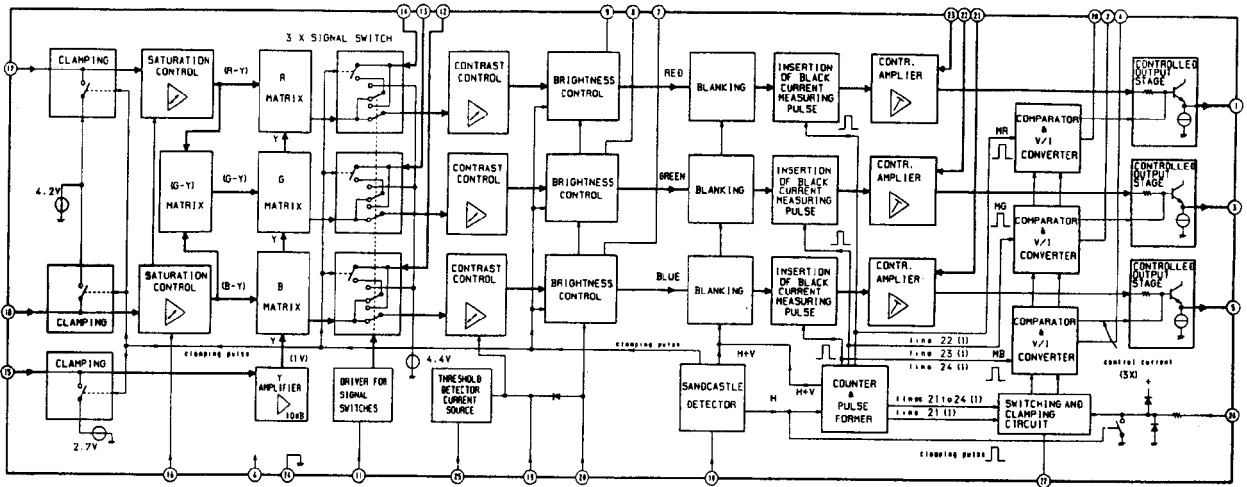

**• A Board**

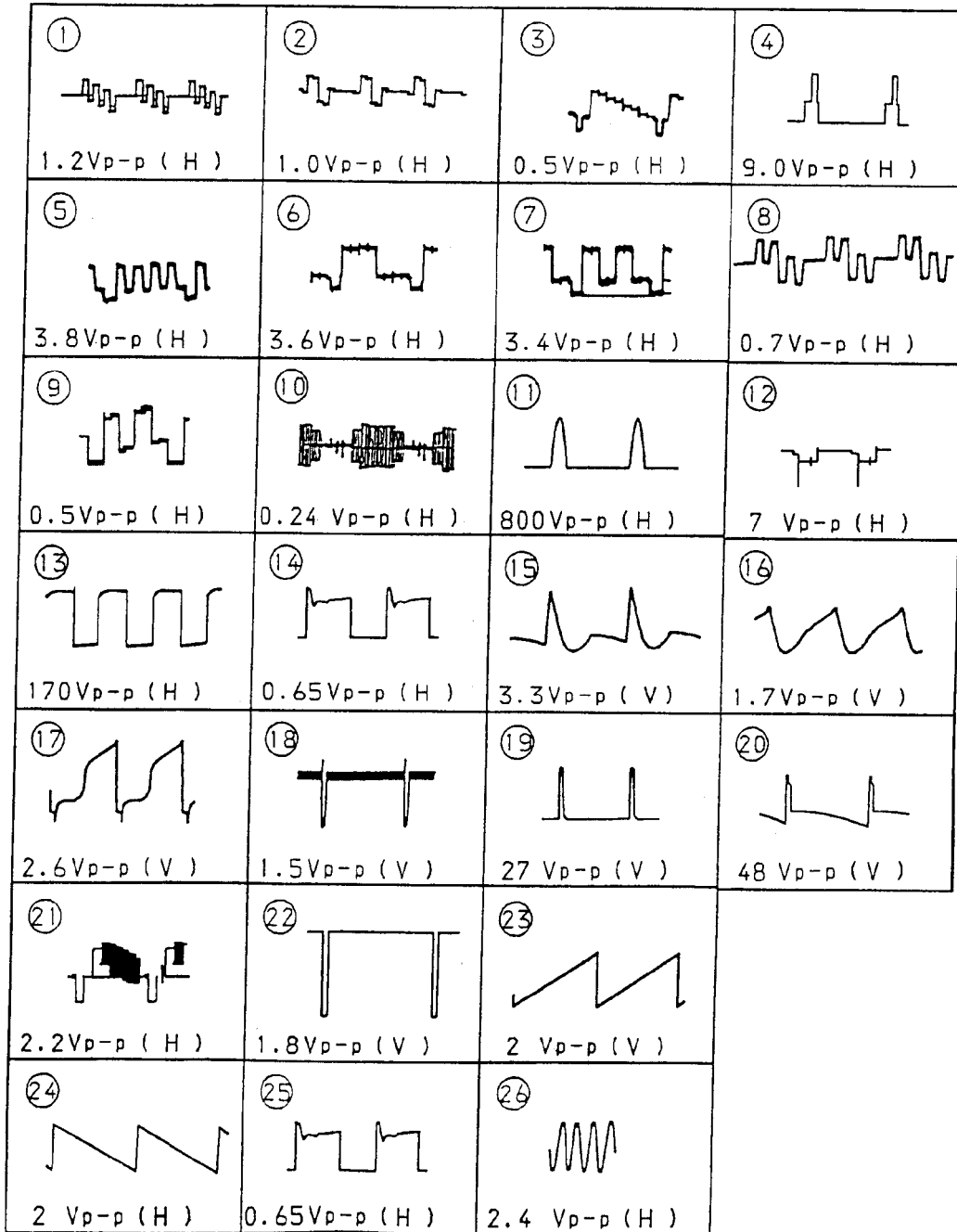

TO C BOARD  
CNC73

TO COATING E

PICTURE TUBE

TO C BOARD  
CNC72

TO C BOARD  
CNC74

Y  
Y  
Y  
Y  
Y  
Y  
82  
Y



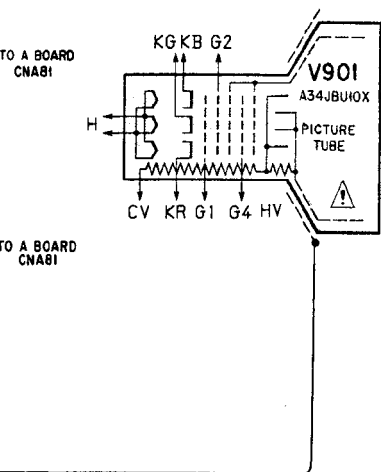

• C Board

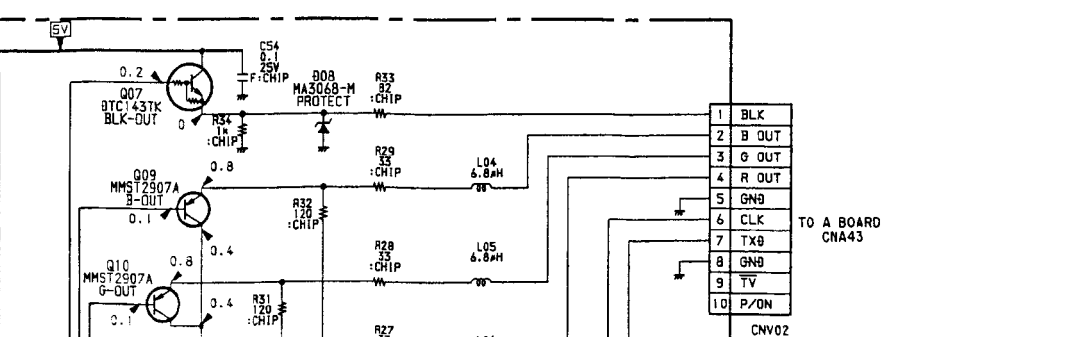
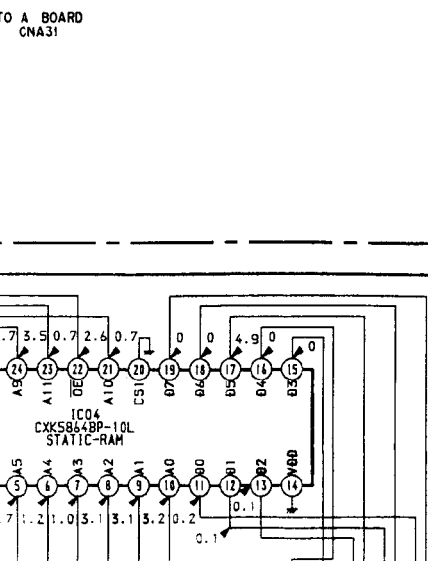
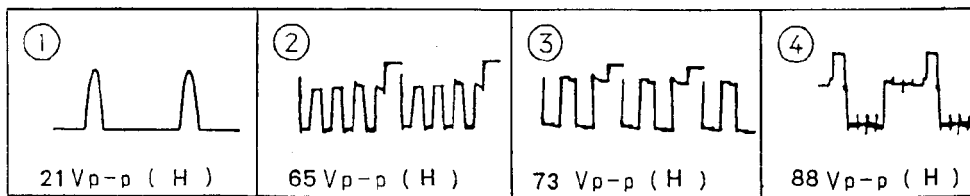

— C Board —

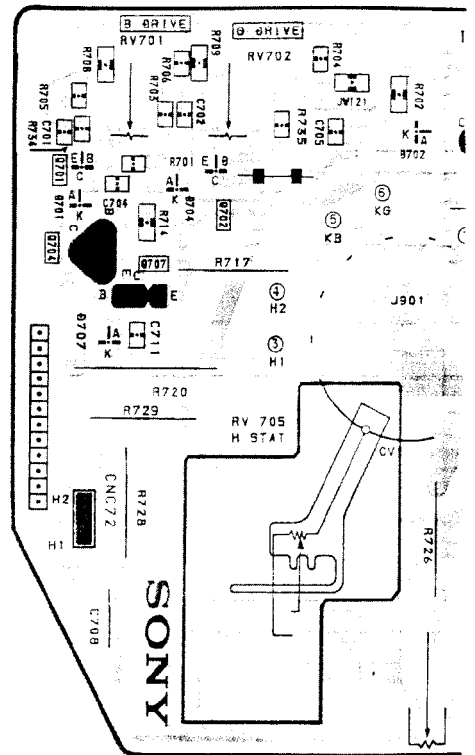

For Service Manuals Contact  
**MAURITRON TECHNICAL SERVICES**  
 8 Cherry Tree Rd, Chinnor  
 Oxon OX9 4QY  
 Tel:- 01844-351694 Fax:- 01844-352554  
 Email:- enquiries@mauritron.co.uk

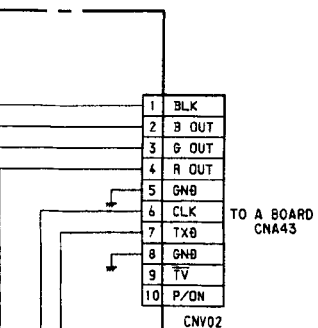
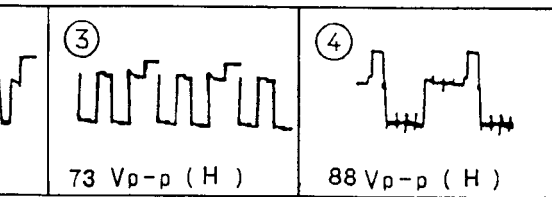

— V Board — (KV-M1411U ONLY)

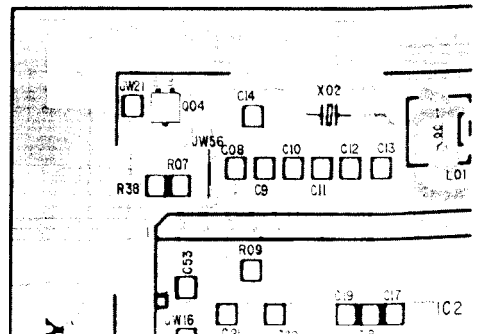

- C Board -

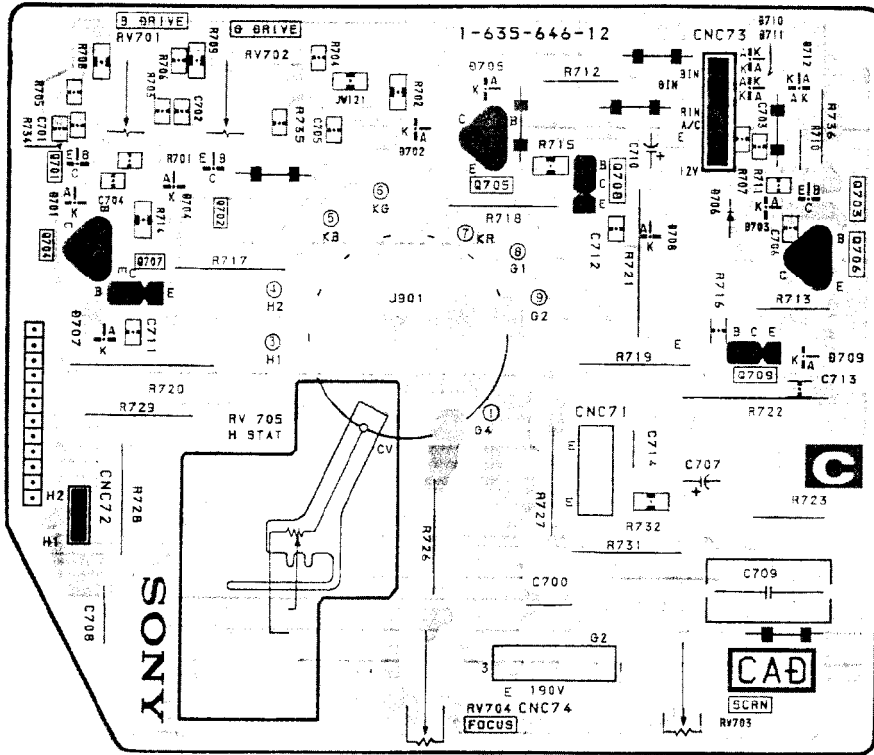

- V Board - (KV-M1411U ONLY)

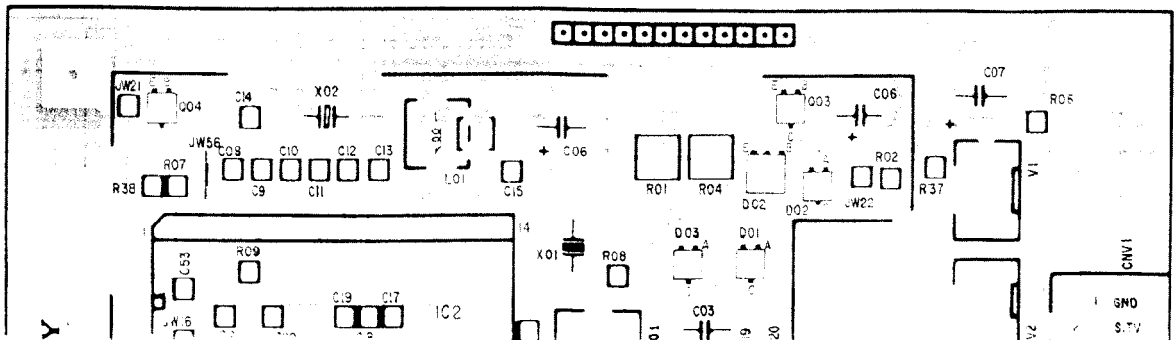

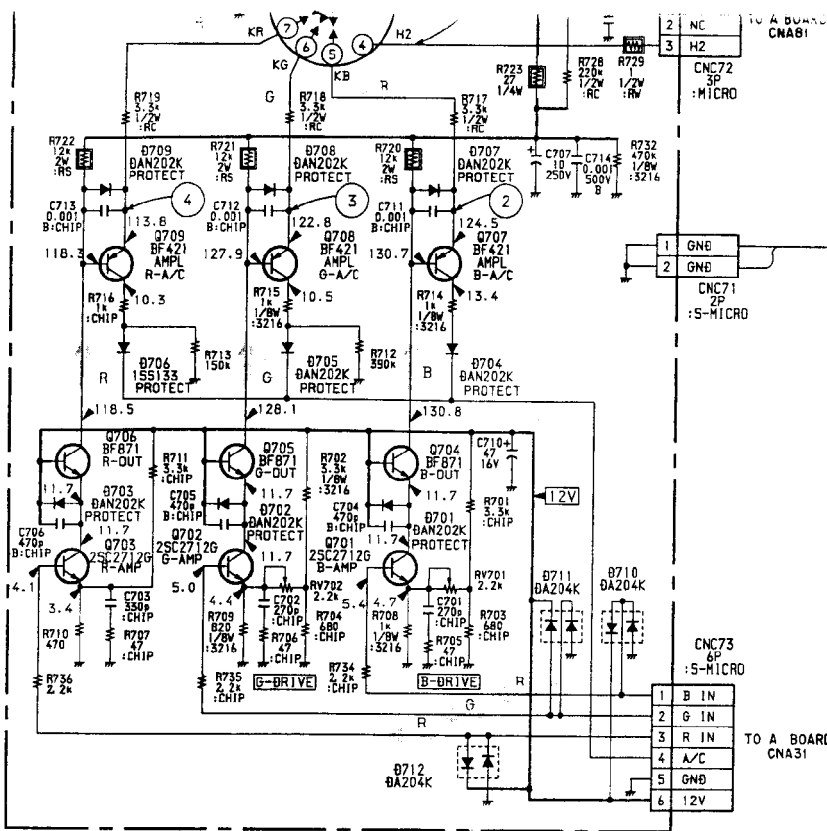

For Service Manuals Contact  
**MAURITRON TECHNICAL SERVICES**  
 8 Cherry Tree Rd, Chinnor  
 Oxon OX9 4QY  
 Tel: 01844-351694 Fax: 01844-352554  
 Email: enquiries@mauritron.co.uk

(KV-M1411U ONLY)

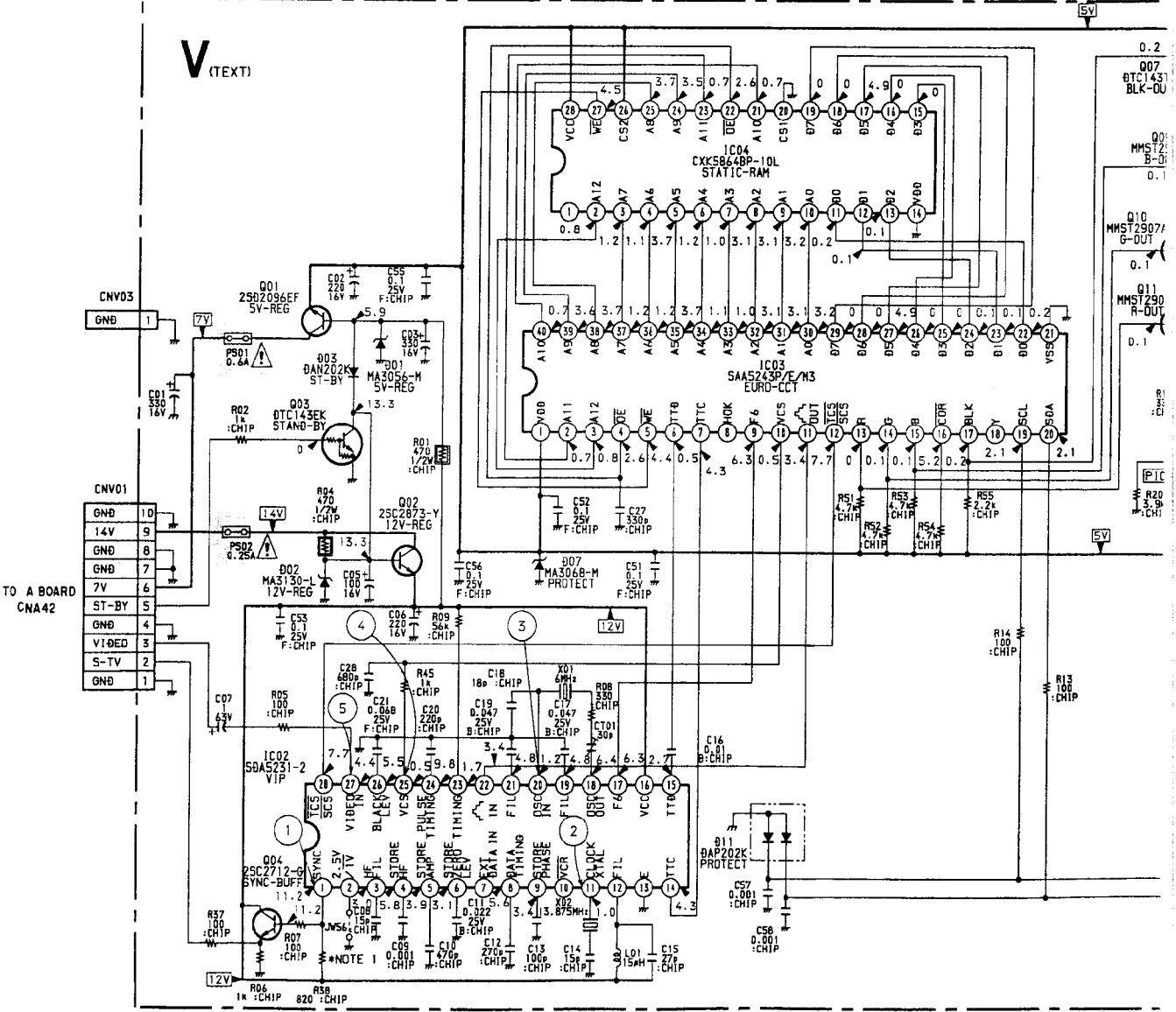

C  
D  
E  
F  
G  
H  
I  
J  
K  
L  
M

• C  
1  
2

• C Board

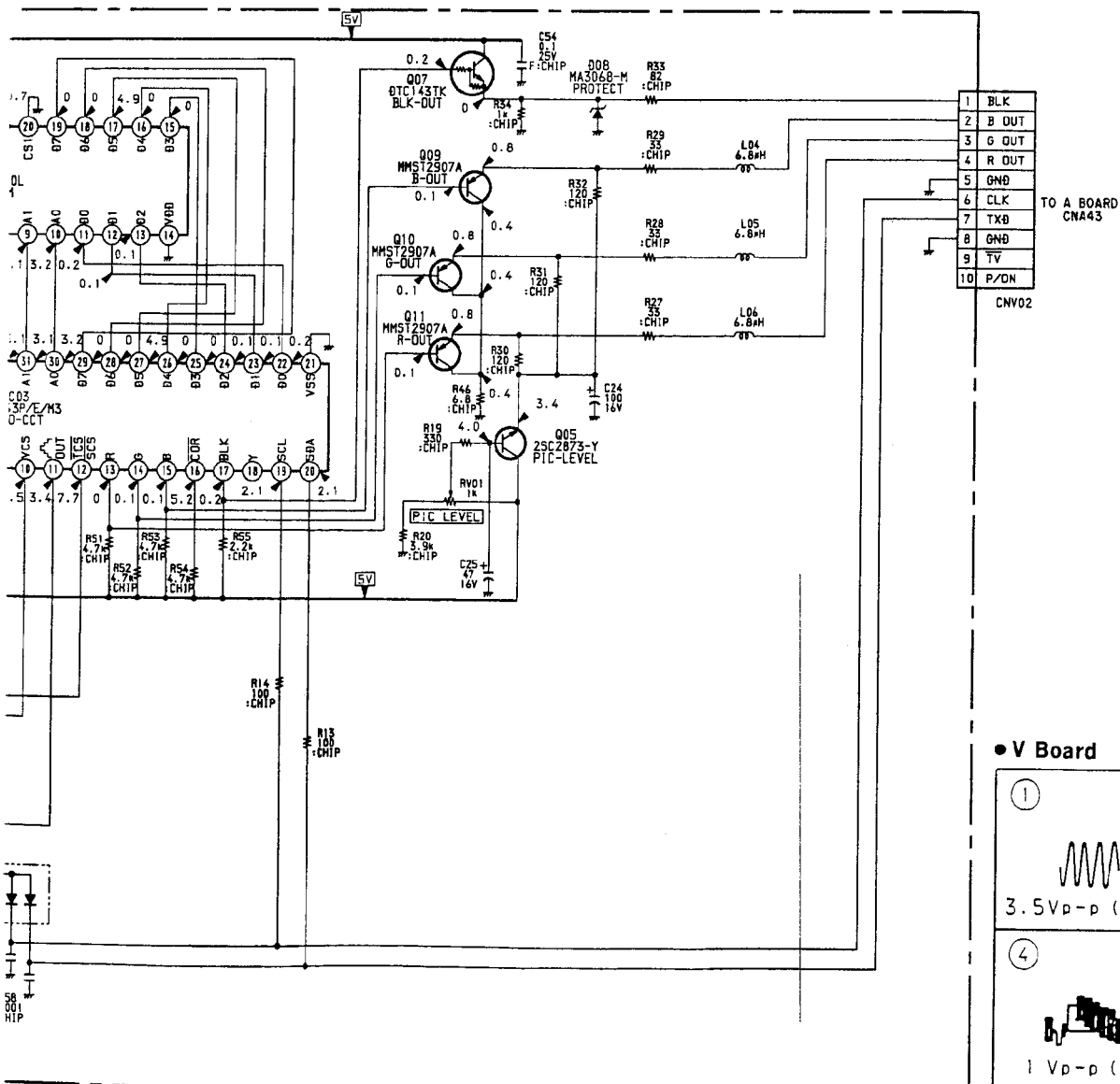
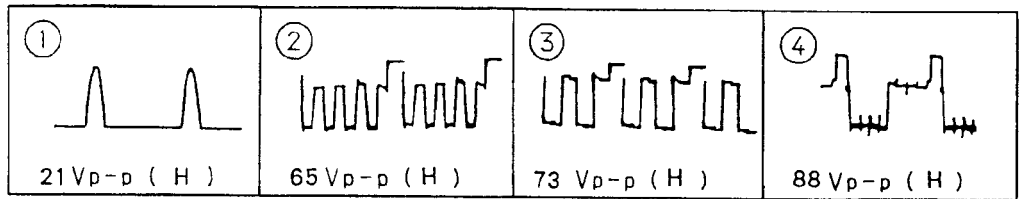

• V Board

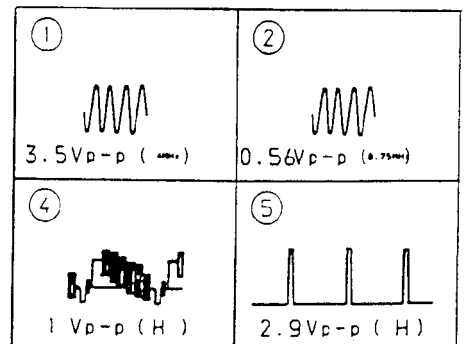



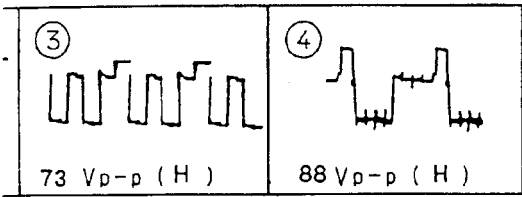
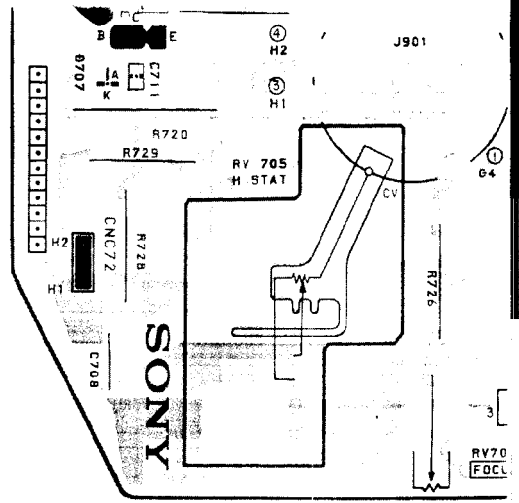

For Service Manuals Contact  
**MAURITRON TECHNICAL SERVICES**  
 8 Cherry Tree Rd, Chinnor  
 Oxon OX9 4QY  
 Tel: 01844-351694 Fax: 01844-352554  
 Email: enquiries@mauritron.co.uk

— V Board — (KV-M1411U ONLY)

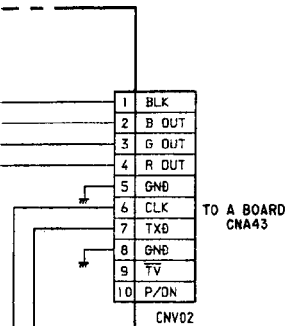
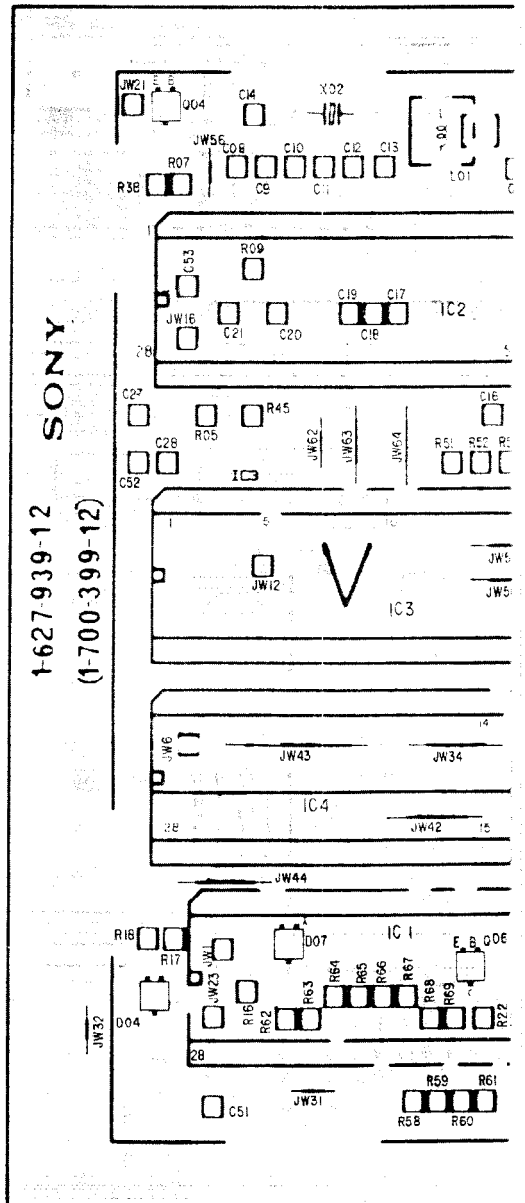

• V Board

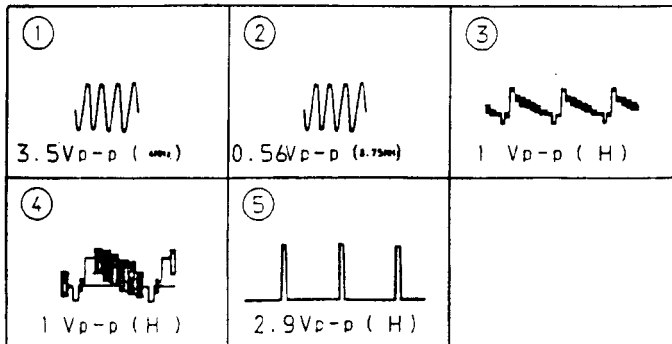

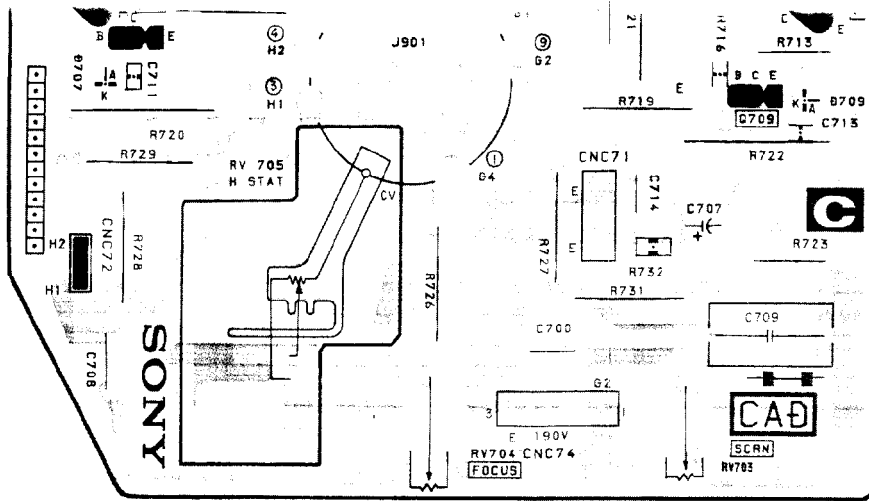

For Service Manuals Contact  
**MAURITRON TECHNICAL SERVICES**  
 8 Cherry Tree Rd, Chinnor  
 Oxon OX9 4QY  
 Tel: 01844-351694 Fax: 01844-352554  
 Email: enquiries@mauritron.co.uk

— V Board — (KV-M1411U ONLY)

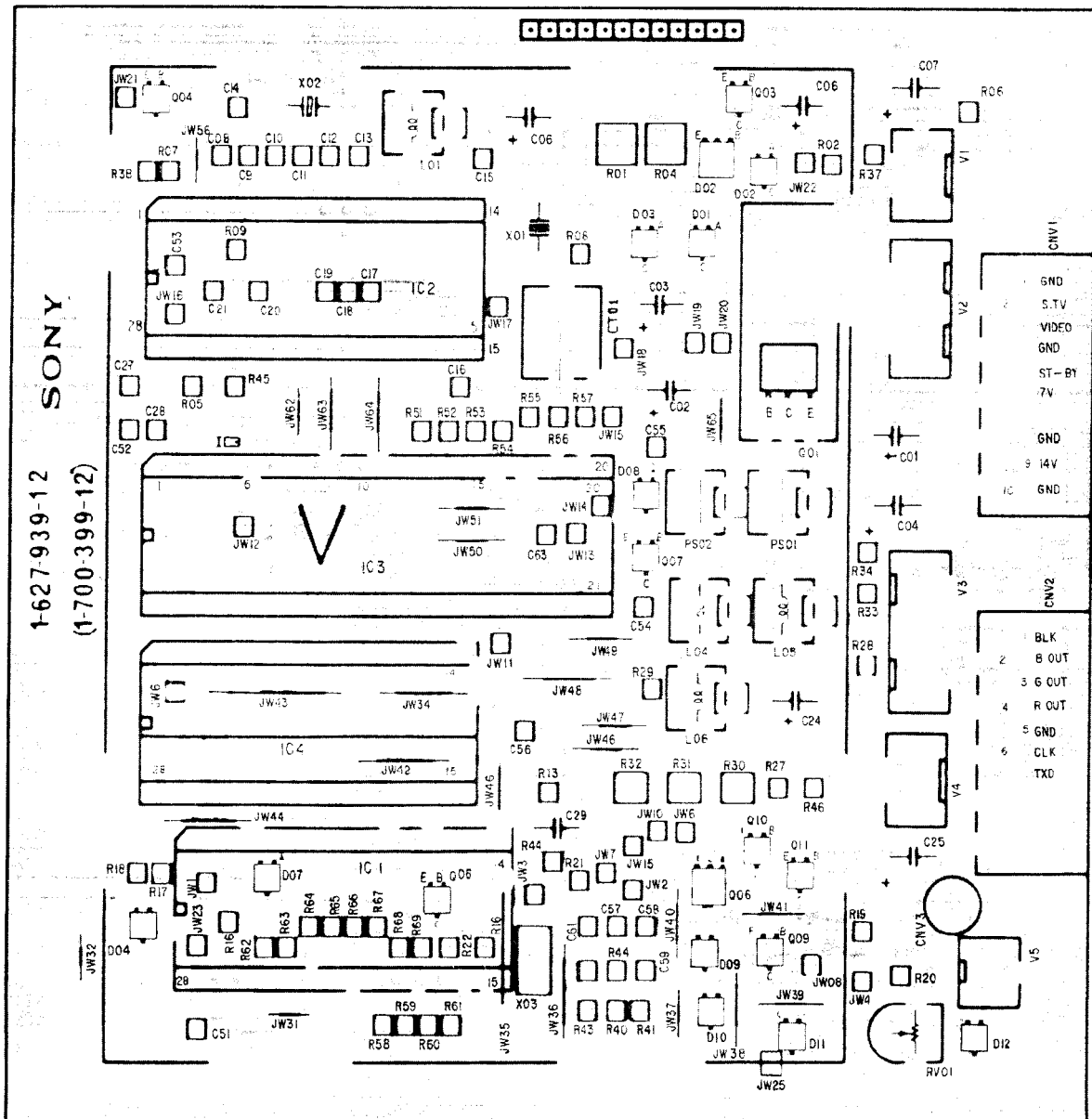

### 5-3. SEMICONDUCTORS

KEY-C00SV-F

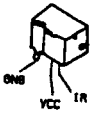

STR54041

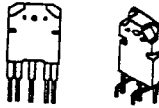

$\mu$ PC1488H

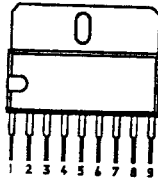

DTA143EK  
DTA143TK  
DTA144EK  
DTC124EK  
DTC143EK  
DTC143TK  
DTC144EK  
2SA1162G  
2SB1295-UL6  
2SC2712YG

2SD2096-EF



L78LR05D-MA



SDA5231-2  
CXK5864BP-10L  
TDA3505-V1  
FCB61C65-70P  
TC5565APL-15L

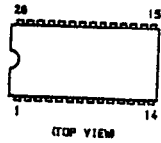

$\mu$ PC574J

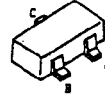
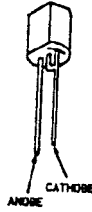

MA152WK

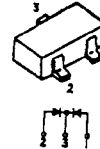

BC637-16  
2SA1091-0

M5F78M12L

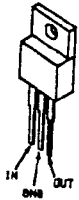

TDA3827-V3  
TDA7245

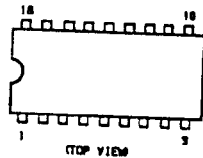

BF871



DAP202K



PCA84C840P-011

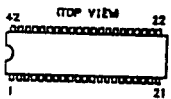

TDA4510/V8  
TDA4660V2

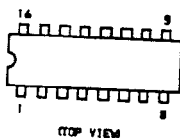

BF959-AMMO



2SC2410SN

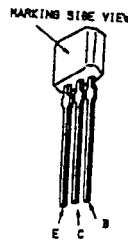

1SS226

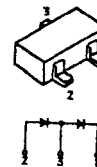

RC4558P  
ST24C02AB1

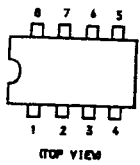

TDA8304

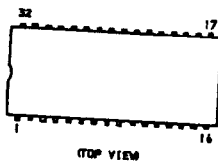

BU508AS2

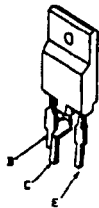

2SC2688-LK



ERA83-006  
RD5.6ES-B2  
RD6.8ES-B1  
UZ5.1BS-B  
HZS8.2N-B3  
1SS119  
1SS120

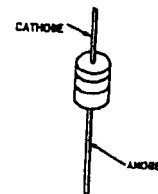

SAA3246P/E/M3

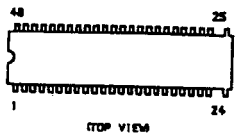

2SD1623R

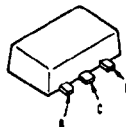

2SD1408-Y



For Service Manuals Contact  
MAURITRON TECHNICAL SERVICES  
8 Cherry Tree Rd, Chinnor  
Oxon OX9 4QY  
Tel:- 01844-351694 Fax:- 01844-352554  
Email:- enquiries@mauritron.co.uk

ERC06-15S

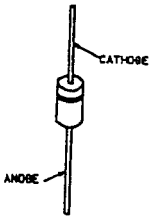

SPR-54MVW

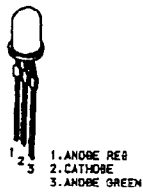

EGP20G  
RGP02-17  
R2M  
RU-3AM

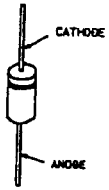

RBV-406H-01

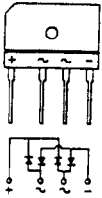

RD13M1  
RD5.1M-B2  
RD5.6M-B2  
RD6.8M-B2

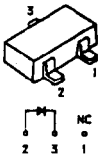

For Service Manuals Contact  
**MAURITRON TECHNICAL SERVICES**  
 8 Cherry Tree Rd, Chinnor  
 Oxon OX9 4QY  
 Tel: 01844-351664 Fax: 01844-352554  
 Email: enquiries@maurtron.co.uk

U05G



## SECTION 6 EXPLODED VIEW

**NOTE:**

- Items with no part number and no description are not stocked because they are seldom required for routine service.
- The construction parts of an assembled part are indicated with a collation number in the remark column.
- Items marked "★" are not stocked since they are seldom required for routine service. Some delay should be anticipated when ordering these items.

The components identified by shading and mark are critical for safety. Replace only with part number specified.

- : BVTP3×12 7-685-648-79
- : BVTP4×16 7-685-663-79

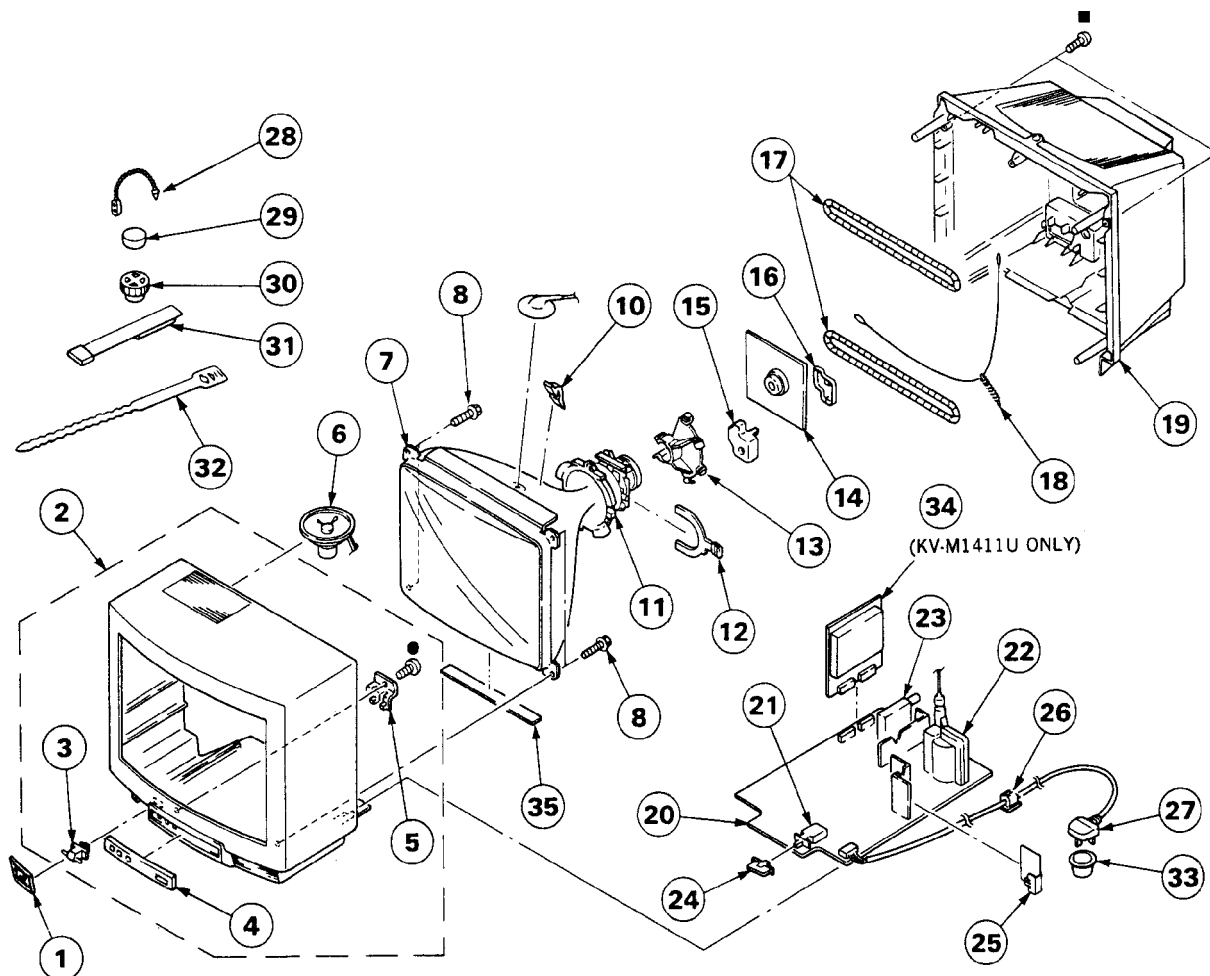

REF.NO.	PART NO.	DESCRIPTION	REMARK	REF.NO.	PART NO.	DESCRIPTION	REMARK
1	4-200-403-11	LID, CONTROL (WHITE)		19	4-200-410-01	COVER, REAR (DARK GRAY)	
	4-200-403-21	LID, CONTROL (BLACK)			4-200-410-11	COVER, REAR (LIGHT GRAY)	
2	X-4200-049-2	CABINET ASSY(WITH BEZEL ASSY)(WHITE)	3-5	20	★A-1632-012-A	A BOARD, COMPLETE	
	X-4200-049-3	CABINET ASSY(WITH BEZEL ASSY)(BLACK)	3-5	21	▲1-571-433-12	SWITCH, PUSH (AC POWER)	
3	3-703-035-11	SHAFT, LID		22	▲1-439-432-11	TRANSFORMER ASSY, FLYBACK (UX-1620)	
4	4-200-406-01	WINDOW, ORNAMENTAL		23	▲1-465-542-11	TUNER, UHF (BT-3U601)	
5	4-200-405-01	BUTTON, MULTI		24	4-200-404-01	BUTTON, POWER	
6	1-544-374-11	SPEAKER		25	★4-200-400-01	PLATE, INSULATION	
7	▲8-735-555-75	PICTURE TUBE (A34JBU10X)		26	▲4-389-202-04	HOLDER, AC CORD	
8	4-307-249-00	SCREW (5), TAPPING		27	▲1-575-807-11	CORD, POWER (WITH CONNECTOR)	
10	3-704-495-01	SPACER, DY		28	4-308-870-00	CLIP, LEAD WIRE	
11	▲1-451-249-31	DEFLECTION YOKE (Y14NDA2)		29	1-452-032-00	MAGNET, DISK: 10MM φ	
12	1-452-277-00	MAGNET, BMC		30	1-452-094-00	MAGNET, ROTATABLE DISK: 15MM φ	
13	★4-385-422-01	HOLDER, LEAD		31	X-4309-608-0	PERMALLOY ASSY, CONVERGENCE	
14	★A-1638-008-A	C BOARD, COMPLETE		32	3-701-007-00	BAND, BINDING	
15	★4-374-912-01	COVER (MAIN), CV VOL		33	★4-200-344-01	COVER, PLUG	
16	★4-374-913-01	COVER (REAR LID), CV VOL		34	★A-1645-012-A	V BOARD, COMPLETE (KV-M1411U ONLY)	
17	▲1-426-145-21	COIL, DEGAUSSING		35	4-389-350-11	CUSHION, PICTURE TUBE	
18	4-369-318-00	SPRING, TENSION					

# SECTION 7 ELECTRICAL PARTS LIST

**A**

**NOTE:**

The components identified by shading and mark  $\Delta$  are critical for safety.  
Replace only with part number specified.

• Items marked " \* " are not stocked since they are seldom required for routine service. Some delay should be anticipated when ordering these items.

When indicating parts by reference number, please include the board name.

• All variable and adjustable resistors have characteristic curve B, unless otherwise noted.

CAPACITORS                      COILS  
• MF :  $\mu$ F, PF :  $\mu$ F              • MMH : mH, UH :  $\mu$ H

**RESISTORS**

• All resistors are in ohms  
• F : nonflammable

REF.NO.	PART NO.	DESCRIPTION	REMARK	REF.NO.	PART NO.	DESCRIPTION	REMARK
	*A-1632-012-A	A BOARD, COMPLETE *****		C132	1-163-029-11	CERAMIC CHIP 0.0047MF	50V
	4-200-399-01	SPACER, IC		C133	1-164-232-11	CERAMIC CHIP 0.01MF	10% 50V
	4-201-057-01	COVER, FUSE		C134	1-106-365-00	MYLAR 0.0082MF	10% 400V
	*4-341-751-01	EYELET		C135	1-163-033-00	CERAMIC CHIP 0.022MF	50V
	*4-341-752-01	EYELET		C136	1-163-033-00	CERAMIC CHIP 0.022MF	50V
		<CAPACITOR>		C138	1-216-295-00	METAL GLAZE 0 5%	1/10W
				C139	1-164-232-11	CERAMIC CHIP 0.01MF	10% 50V
				C140	1-163-017-00	CERAMIC CHIP 0.0047MF	10% 50V
C001	1-126-101-11	ELECT 100MF	20% 16V	C141	1-163-017-00	CERAMIC CHIP 0.0047MF	10% 50V
C002	1-106-220-00	MYLAR 0.1MF	10% 100V	C142	1-163-017-00	CERAMIC CHIP 0.0047MF	10% 50V
C003	1-163-031-11	CERAMIC CHIP 0.01MF	50V	C143	1-163-809-11	CERAMIC CHIP 0.047MF	10% 25V
C004	1-123-382-00	ELECT 3.3MF	20% 50V	C144	1-163-017-00	CERAMIC CHIP 0.0047MF	10% 50V
C005	1-126-101-11	ELECT 100MF	20% 16V	C148	1-164-665-11	CERAMIC CHIP 0.039MF	10% 50V
C006	1-163-117-00	CERAMIC CHIP 100PF	5% 50V	C149	1-126-101-11	ELECT 100MF	20% 16V
C007	1-124-907-11	ELECT 10MF	20% 50V	C151	1-124-907-11	ELECT 10MF	20% 50V
C009	1-124-907-11	ELECT 10MF	20% 50V	C154	1-164-232-11	CERAMIC CHIP 0.01MF	10% 50V
C010	1-163-117-00	CERAMIC CHIP 100PF	5% 50V	C157	1-124-927-11	ELECT 4.7MF	20% 50V
C012	1-126-233-11	ELECT 22MF	20% 50V	C160	1-163-117-00	CERAMIC CHIP 100PF	5% 50V
C018	1-163-031-11	CERAMIC CHIP 0.01MF	50V	C161	1-163-129-00	CERAMIC CHIP 330PF	5% 50V
C020	1-124-903-11	ELECT 1MF	20% 50V	C163	1-164-232-11	CERAMIC CHIP 0.01MF	10% 50V
C021	1-124-907-11	ELECT 10MF	20% 50V	C201	1-126-233-11	ELECT 22MF	20% 50V
C023	1-124-907-11	ELECT 10MF	20% 50V	C202	1-124-925-11	ELECT 2.2MF	20% 50V
C024	1-124-907-11	ELECT 10MF	20% 50V	C203	1-163-009-11	CERAMIC CHIP 0.001MF	10% 50V
C025	1-126-233-11	ELECT 22MF	20% 50V	C204	1-124-480-11	ELECT 470MF	20% 25V
C026	1-124-903-11	ELECT 1MF	20% 50V	C206	1-163-011-11	CERAMIC CHIP 0.0015MF	10% 50V
C030	1-124-903-11	ELECT 1MF	20% 50V	C207	1-124-925-11	ELECT 2.2MF	20% 50V
C037	1-163-034-00	CERAMIC CHIP 0.033MF	50V	C208	1-126-104-11	ELECT 470MF	20% 35V
C038	1-163-009-11	CERAMIC CHIP 0.001MF	10% 50V	C209	1-124-910-11	ELECT 47MF	20% 50V
C039	1-163-117-00	CERAMIC CHIP 100PF	5% 50V	C211	1-163-077-00	CERAMIC CHIP 0.1MF	10% 25V
C041	1-124-478-11	ELECT 100MF	20% 25V	C212	1-164-348-11	CERAMIC CHIP 0.12MF	10% 25V
C055	1-163-075-00	CERAMIC CHIP 0.047MF	50V	C302	1-163-059-00	CERAMIC CHIP 0.01MF	50V
C058	1-163-077-00	CERAMIC CHIP 0.1MF	10% 25V	C303	1-163-059-00	CERAMIC CHIP 0.01MF	50V
C059	1-163-031-11	CERAMIC CHIP 0.01MF	50V	C304	1-163-038-00	CERAMIC CHIP 0.1MF	25V
C062	1-126-101-11	ELECT 100MF	20% 16V	C305	1-124-910-11	ELECT 47MF	20% 50V
C063	1-163-017-00	CERAMIC CHIP 0.0047MF	10% 50V	C306	1-106-220-00	MYLAR 0.1MF	10% 100V
C101	1-124-477-11	ELECT 47MF	20% 16V	C307	1-163-038-00	CERAMIC CHIP 0.1MF	25V
C102	1-124-910-11	ELECT 47MF	20% 50V	C308	1-124-910-11	ELECT 47MF	20% 50V
C103	1-163-105-00	CERAMIC CHIP 33PF	5% 50V	C309	1-163-099-00	CERAMIC CHIP 18PF	5% 50V
C104	1-164-665-11	CERAMIC CHIP 0.039MF	10% 50V	C314	1-163-103-00	CERAMIC CHIP 27PF	5% 50V
C105	1-164-665-11	CERAMIC CHIP 0.039MF	10% 50V	C316	1-163-377-11	CERAMIC CHIP 100PF	5% 50V
C107	1-124-477-11	ELECT 47MF	20% 16V	C317	1-163-093-00	CERAMIC CHIP 10PF	5% 50V
C112	1-163-115-00	CERAMIC CHIP 82PF	5% 50V	C318	1-164-232-11	CERAMIC CHIP 0.01MF	10% 50V
C114	1-163-115-00	CERAMIC CHIP 82PF	5% 50V	C319	1-163-038-00	CERAMIC CHIP 0.1MF	25V
C115	1-163-031-11	CERAMIC CHIP 0.01MF	50V	C321	1-163-038-00	CERAMIC CHIP 0.1MF	25V
C120	1-163-173-00	CERAMIC CHIP 47PF	5% 50V	C323	1-163-055-00	CERAMIC CHIP 0.0047MF	10% 50V
C123	1-163-137-00	CERAMIC CHIP 680PF	5% 50V	C329	1-131-367-00	TANTALUM 22MF	10% 16V
C125	1-124-917-11	ELECT 33MF	20% 50V	C330	1-163-117-00	CERAMIC CHIP 100PF	5% 50V
C128	1-163-025-11	CERAMIC CHIP 0.001MF	50V	C331	1-124-927-11	ELECT 4.7MF	20% 50V
C130	1-136-171-00	FILM 0.33MF	5% 50V	C332	1-130-783-00	MYLAR 0.33MF	10% 100V
C131	1-164-232-11	CERAMIC CHIP 0.01MF	10% 50V	C333	1-163-037-11	CERAMIC CHIP 0.022MF	10% 25V
				C334	1-163-063-00	CERAMIC CHIP 0.022MF	10% 50V

For Service Manuals Contact  
MAURITRON TECHNICAL SERVICES  
8 Cherry Tree Rd, Chinnor  
Oxon OX9 4QY  
Tel: 01844-351694 Fax: 01844-352554  
Email: enquiries@mauritron.co.uk







A

REF. NO.	PART NO.	DESCRIPTION	REMARK	REF. NO.	PART NO.	DESCRIPTION	REMARK
Q003	8-729-901-01	TRANSISTOR DTC144EK		JR036	1-216-295-00	METAL GLAZE 0 5% 1/10W	
Q004	8-729-230-49	TRANSISTOR 2SC2712-YG		JR037	1-216-295-00	METAL GLAZE 0 5% 1/10W	
Q005	8-729-923-54	TRANSISTOR DTA143TK					
Q006	8-729-922-66	TRANSISTOR 2SC2410SN		JR038	1-216-295-00	METAL GLAZE 0 5% 1/10W	
Q007	8-729-230-49	TRANSISTOR 2SC2712-YG		JR039	1-216-295-00	METAL GLAZE 0 5% 1/10W	
Q009	8-729-901-01	TRANSISTOR DTC144EK		JR040	1-216-295-00	METAL GLAZE 0 5% 1/10W	
Q015	8-729-230-49	TRANSISTOR 2SC2712-YG		JR041	1-216-295-00	METAL GLAZE 0 5% 1/10W	
Q016	8-729-901-47	TRANSISTOR DTA143EK		JR044	1-216-295-00	METAL GLAZE 0 5% 1/10W	
Q017	8-729-216-22	TRANSISTOR 2SA1162-G					
Q019	8-729-901-06	TRANSISTOR DTA144EK		JR050	1-216-295-00	METAL GLAZE 0 5% 1/10W	
Q020	8-729-901-00	TRANSISTOR DTC124EK		JR060	1-216-295-00	METAL GLAZE 0 5% 1/10W	
Q104	8-729-230-49	TRANSISTOR 2SC2712-YG		JR099	1-216-295-00	METAL GLAZE 0 5% 1/10W	
Q106	8-729-230-49	TRANSISTOR 2SC2712-YG		JR101	1-216-296-00	METAL GLAZE 0 5% 1/8W	
Q107	8-729-216-22	TRANSISTOR 2SA1162-G		JR102	1-216-296-00	METAL GLAZE 0 5% 1/8W	
Q112	8-729-230-49	TRANSISTOR 2SC2712-YG					
Q114	8-729-901-00	TRANSISTOR DTC124EK		JR103	1-216-296-00	METAL GLAZE 0 5% 1/8W	
Q115	8-729-901-00	TRANSISTOR DTC124EK		JR104	1-216-296-00	METAL GLAZE 0 5% 1/8W	
Q123	8-729-230-49	TRANSISTOR 2SC2712-YG		JR105	1-216-296-00	METAL GLAZE 0 5% 1/8W	
Q141	8-729-014-99	TRANSISTOR BF959-AMMO		JR106	1-216-296-00	METAL GLAZE 0 5% 1/8W	
Q302	8-729-230-49	TRANSISTOR 2SC2712-YG		JR107	1-216-296-00	METAL GLAZE 0 5% 1/8W	
Q304	8-729-230-49	TRANSISTOR 2SC2712-YG					
Q305	8-729-230-49	TRANSISTOR 2SC2712-YG		JR108	1-216-296-00	METAL GLAZE 0 5% 1/8W	
Q307	8-729-216-22	TRANSISTOR 2SA1162-G		JR109	1-216-296-00	METAL GLAZE 0 5% 1/8W	
Q310	8-729-230-49	TRANSISTOR 2SC2712-YG		JR110	1-216-296-00	METAL GLAZE 0 5% 1/8W	
Q311	8-729-216-22	TRANSISTOR 2SA1162-G		JR111	1-216-296-00	METAL GLAZE 0 5% 1/8W	
Q401	8-729-230-49	TRANSISTOR 2SC2712-YG		JR112	1-216-296-00	METAL GLAZE 0 5% 1/8W	
Q457	8-729-216-22	TRANSISTOR 2SA1162-G					
Q504	8-729-230-49	TRANSISTOR 2SC2712-YG		JR116	1-216-296-00	METAL GLAZE 0 5% 1/8W	
Q505	8-729-216-22	TRANSISTOR 2SA1162-G		JR117	1-216-296-00	METAL GLAZE 0 5% 1/8W	
Q601	8-729-906-74	TRANSISTOR BC637-16		JR118	1-216-296-00	METAL GLAZE 0 5% 1/8W	
Q801	8-729-119-80	TRANSISTOR 2SC2688-LK		JR119	1-216-296-00	METAL GLAZE 0 5% 1/8W	
Q802	8-729-925-64	TRANSISTOR BU508AS2		JR121	1-216-296-00	METAL GLAZE 0 5% 1/8W	
Q803	8-729-202-03	TRANSISTOR 2SD1408-Y					
<RESISTOR>							
JR001	1-216-295-00	METAL GLAZE 0 5% 1/10W		JR122	1-216-296-00	METAL GLAZE 0 5% 1/8W	
JR002	1-216-295-00	METAL GLAZE 0 5% 1/10W		JR123	1-216-296-00	METAL GLAZE 0 5% 1/8W	
JR003	1-216-295-00	METAL GLAZE 0 5% 1/10W		JR124	1-216-296-00	METAL GLAZE 0 5% 1/8W	
JR004	1-216-295-00	METAL GLAZE 0 5% 1/10W		JR125	1-216-296-00	METAL GLAZE 0 5% 1/8W	
JR005	1-216-295-00	METAL GLAZE 0 5% 1/10W		JR126	1-216-296-00	METAL GLAZE 0 5% 1/8W	
JR006	1-216-295-00	METAL GLAZE 0 5% 1/10W					
JR007	1-216-295-00	METAL GLAZE 0 5% 1/10W		JR127	1-216-296-00	METAL GLAZE 0 5% 1/8W	
JR008	1-216-295-00	METAL GLAZE 0 5% 1/10W		JR128	1-216-296-00	METAL GLAZE 0 5% 1/8W	
JR009	1-216-295-00	METAL GLAZE 0 5% 1/10W		JR129	1-216-296-00	METAL GLAZE 0 5% 1/8W	
JR010	1-216-295-00	METAL GLAZE 0 5% 1/10W		JR130	1-216-296-00	METAL GLAZE 0 5% 1/8W	
JR011	1-216-295-00	METAL GLAZE 0 5% 1/10W		JR131	1-216-296-00	METAL GLAZE 0 5% 1/8W	
JR012	1-216-295-00	METAL GLAZE 0 5% 1/10W					
JR015	1-216-295-00	METAL GLAZE 0 5% 1/10W		JR133	1-216-296-00	METAL GLAZE 0 5% 1/8W	
JR016	1-216-295-00	METAL GLAZE 0 5% 1/10W		JR134	1-216-296-00	METAL GLAZE 0 5% 1/8W	
JR017	1-216-295-00	METAL GLAZE 0 5% 1/10W		JR135	1-216-296-00	METAL GLAZE 0 5% 1/8W	
JR018	1-216-295-00	METAL GLAZE 0 5% 1/10W		JR136	1-216-296-00	METAL GLAZE 0 5% 1/8W	
JR019	1-216-295-00	METAL GLAZE 0 5% 1/10W		JR137	1-216-296-00	METAL GLAZE 0 5% 1/8W	
JR020	1-216-295-00	METAL GLAZE 0 5% 1/10W					
JR021	1-216-295-00	METAL GLAZE 0 5% 1/10W		JR139	1-216-296-00	METAL GLAZE 0 5% 1/8W	
JR022	1-216-295-00	METAL GLAZE 0 5% 1/10W		JR141	1-216-296-00	METAL GLAZE 0 5% 1/8W	
JR024	1-216-295-00	METAL GLAZE 0 5% 1/10W		JR144	1-216-296-00	METAL GLAZE 0 5% 1/8W	
JR026	1-216-295-00	METAL GLAZE 0 5% 1/10W		JR146	1-216-296-00	METAL GLAZE 0 5% 1/8W	
JR027	1-216-295-00	METAL GLAZE 0 5% 1/10W		JR147	1-216-296-00	METAL GLAZE 0 5% 1/8W	
JR028	1-216-295-00	METAL GLAZE 0 5% 1/10W					
JR029	1-216-295-00	METAL GLAZE 0 5% 1/10W		JR148	1-216-296-00	METAL GLAZE 0 5% 1/8W	
JR030	1-216-295-00	METAL GLAZE 0 5% 1/10W		JR149	1-216-296-00	METAL GLAZE 0 5% 1/8W	
JR034	1-216-295-00	METAL GLAZE 0 5% 1/10W		JR150	1-216-296-00	METAL GLAZE 0 5% 1/8W	
JR035	1-216-295-00	METAL GLAZE 0 5% 1/10W		JR154	1-216-296-00	METAL GLAZE 0 5% 1/8W	
				JR155	1-216-296-00	METAL GLAZE 0 5% 1/8W	
				JR182	1-216-296-00	METAL GLAZE 0 5% 1/8W	
				JR183	1-216-296-00	METAL GLAZE 0 5% 1/8W	
				JR184	1-216-296-00	METAL GLAZE 0 5% 1/8W	
				RO01	1-216-069-00	METAL GLAZE 6.8K 5% 1/10W	
				RO02	1-216-081-00	METAL GLAZE 22K 5% 1/10W	
				RO03	1-216-081-00	METAL GLAZE 22K 5% 1/10W	
				RO04	1-216-083-00	METAL GLAZE 27K 5% 1/10W	
				RO06	1-216-246-00	METAL GLAZE 100K 5% 1/8W	
				RO07	1-216-190-00	METAL GLAZE 470 5% 1/8W	
				RO08	1-216-049-00	METAL GLAZE 1K 5% 1/10W	
				RO09	1-216-049-00	METAL GLAZE 1K 5% 1/10W	



REF. NO.	PART NO.	DESCRIPTION	REMARK	REF. NO.	PART NO.	DESCRIPTION	REMARK
R010	1-216-198-00	METAL GLAZE 1K 5%	1/8W	R100	1-216-017-00	METAL GLAZE 47 5%	1/10W
R011	1-216-035-00	METAL GLAZE 270 5%	1/10W	R101	1-216-069-00	METAL GLAZE 6.8K 5%	1/10W
R012	1-216-240-00	METAL GLAZE 56K 5%	1/8W	R102	1-216-061-00	METAL GLAZE 3.3K 5%	1/10W
R013	1-216-077-00	METAL GLAZE 15K 5%	1/10W	R103	1-216-057-00	METAL GLAZE 2.2K 5%	1/10W
R014	1-216-748-11	METAL GLAZE 39K 5%	1/10W	R104	1-216-057-00	METAL GLAZE 2.2K 5%	1/10W
R015	1-216-230-00	METAL GLAZE 22K 5%	1/8W	R105	1-216-109-00	METAL GLAZE 330K 5%	1/10W
R016	1-216-049-00	METAL GLAZE 1K 5%	1/10W	R106	1-216-081-00	METAL GLAZE 22K 5%	1/10W
R017	1-216-081-00	METAL GLAZE 22K 5%	1/10W	R109	1-216-190-00	METAL GLAZE 470 5%	1/8W
R018	1-216-065-00	METAL GLAZE 4.7K 5%	1/10W	R110	1-249-437-11	CARBON 47K 5%	1/4W
R019	1-216-065-00	METAL GLAZE 4.7K 5%	1/10W	R111	1-216-085-00	METAL GLAZE 33K 5%	1/10W
R020	1-216-065-00	METAL GLAZE 4.7K 5%	1/10W	R112	1-249-411-11	CARBON 330 5%	1/4W
R021	1-216-049-00	METAL GLAZE 1K 5%	1/10W	R113	1-216-085-00	METAL GLAZE 33K 5%	1/10W
R022	1-216-198-00	METAL GLAZE 1K 5%	1/8W	R114	1-216-238-00	METAL GLAZE 47K 5%	1/8W
R023	1-216-051-00	METAL GLAZE 1.2K 5%	1/10W	R115	1-216-045-00	METAL GLAZE 680 5%	1/10W
R024	1-216-065-00	METAL GLAZE 4.7K 5%	1/10W	R116	1-216-049-00	METAL GLAZE 1K 5%	1/10W
R025	1-216-097-00	METAL GLAZE 100K 5%	1/10W	R118	1-216-037-00	METAL GLAZE 330 5%	1/10W
R026	1-216-089-00	METAL GLAZE 47K 5%	1/10W	R119	1-216-045-00	METAL GLAZE 680 5%	1/10W
R028	1-216-085-00	METAL GLAZE 33K 5%	1/10W	R120	1-216-043-00	METAL GLAZE 560 5%	1/10W
R029	1-216-041-00	METAL GLAZE 470 5%	1/10W	R122	1-216-043-00	METAL GLAZE 560 5%	1/10W
R030	1-216-077-00	METAL GLAZE 15K 5%	1/10W	R130	1-249-409-11	CARBON 220 5%	1/4W
R031	1-216-073-00	METAL GLAZE 10K 5%	1/10W	R131	1-216-041-00	METAL GLAZE 470 5%	1/10W
R034	1-216-238-00	METAL GLAZE 47K 5%	1/8W	R132	1-216-035-00	METAL GLAZE 270 5%	1/10W
R035	1-216-077-00	METAL GLAZE 15K 5%	1/10W	R136	1-216-041-00	METAL GLAZE 470 5%	1/10W
R037	1-216-073-00	METAL GLAZE 10K 5%	1/10W	R138	1-216-057-00	METAL GLAZE 2.2K 5%	1/10W
R038	1-216-073-00	METAL GLAZE 10K 5%	1/10W	R139	1-216-295-00	METAL GLAZE 0 5%	1/10W
R039	1-216-073-00	METAL GLAZE 10K 5%	1/10W	R140	1-216-037-00	METAL GLAZE 330 5%	1/10W
R040	1-216-081-00	METAL GLAZE 22K 5%	1/10W	R141	1-216-021-00	METAL GLAZE 68 5%	1/10W
R041	1-216-081-00	METAL GLAZE 22K 5%	1/10W	R142	1-216-063-00	METAL GLAZE 3.9K 5%	1/10W
R042	1-216-081-00	METAL GLAZE 22K 5%	1/10W	R143	1-216-033-00	METAL GLAZE 220 5%	1/10W
R043	1-215-900-11	METAL OXIDE 22K 5%	2W	R144	1-216-065-00	METAL GLAZE 4.7K 5%	1/10W
R044	1-216-105-00	METAL GLAZE 220K 5%	1/10W	R147	1-216-073-00	METAL GLAZE 10K 5%	1/10W
R045	1-216-089-00	METAL GLAZE 47K 5%	1/10W	R148	1-216-017-00	METAL GLAZE 47 5%	1/10W
R046	1-216-081-00	METAL GLAZE 22K 5%	1/10W	R149	1-216-182-00	METAL GLAZE 220 5%	1/8W
R047	1-216-079-00	METAL GLAZE 18K 5%	1/10W	R151	1-216-057-00	METAL GLAZE 2.2K 5%	1/10W
R048	1-216-202-00	METAL GLAZE 1.5K 5%	1/8W	R152	1-216-061-00	METAL GLAZE 3.3K 5%	1/10W
R049	1-216-073-00	METAL GLAZE 10K 5%	1/10W	R153	1-215-867-00	METAL OXIDE 470 5%	1W
R050	1-216-250-00	METAL GLAZE 150K 5%	1/8W	R199	1-216-295-00	METAL GLAZE 0 5%	1/10W
R051	1-216-295-00	METAL GLAZE 0 5%	1/10W	R201	1-216-073-00	METAL GLAZE 10K 5%	1/10W
R052	1-216-065-00	METAL GLAZE 4.7K 5%	1/10W	R202	1-216-057-00	METAL GLAZE 2.2K 5%	1/10W
R053	1-216-049-00	METAL GLAZE 1K 5%	1/10W	R203	1-216-298-00	METAL GLAZE 2.2 5%	1/10W
R054	1-249-395-11	CARBON 15 5%	1/4W	R204	1-247-741-11	CARBON 150 5%	1/2W
R055	1-216-057-00	METAL GLAZE 2.2K 5%	1/10W	R205	1-216-083-00	METAL GLAZE 27K 5%	1/10W
R056	1-216-041-00	METAL GLAZE 470 5%	1/10W	R206	1-216-035-00	METAL GLAZE 270 5%	1/10W
R058	1-249-434-11	CARBON 27K 5%	1/4W	R207	1-216-298-00	METAL GLAZE 2.2 5%	1/10W
R059	1-216-089-00	METAL GLAZE 47K 5%	1/10W	R303	1-216-033-00	METAL GLAZE 220 5%	1/10W
R060	1-216-234-00	METAL GLAZE 33K 5%	1/8W	R304	1-216-033-00	METAL GLAZE 220 5%	1/10W
R061	1-216-079-00	METAL GLAZE 18K 5%	1/10W	R305	1-216-033-00	METAL GLAZE 220 5%	1/10W
R062	1-216-242-00	METAL GLAZE 68K 5%	1/8W	R306	1-216-059-00	METAL GLAZE 2.7K 5%	1/10W
R064	1-216-091-00	METAL GLAZE 56K 5%	1/10W	R307	1-216-077-00	METAL GLAZE 15K 5%	1/10W
R075	1-216-240-00	METAL GLAZE 56K 5%	1/8W	R309	1-216-055-00	METAL GLAZE 1.8K 5%	1/10W
R076	1-216-198-00	METAL GLAZE 1K 5%	1/8W	R310	1-216-049-00	METAL GLAZE 1K 5%	1/10W
R077	1-216-077-00	METAL GLAZE 15K 5%	1/10W	R311	1-216-051-00	METAL GLAZE 1.2K 5%	1/10W
R078	1-216-049-00	METAL GLAZE 1K 5%	1/10W	R312	1-216-182-00	METAL GLAZE 220 5%	1/8W
R079	1-216-049-00	METAL GLAZE 1K 5%	1/10W	R313	1-216-182-00	METAL GLAZE 220 5%	1/8W
R081	1-216-198-00	METAL GLAZE 1K 5%	1/8W	R314	1-216-033-00	METAL GLAZE 220 5%	1/10W
R082	1-216-049-00	METAL GLAZE 1K 5%	1/10W	R315	1-216-047-00	METAL GLAZE 820 5%	1/10W
R083	1-216-065-00	METAL GLAZE 4.7K 5%	1/10W	R317	1-216-202-00	METAL GLAZE 1.5K 5%	1/8W
R084	1-216-057-00	METAL GLAZE 2.2K 5%	1/10W	R320	1-216-057-00	METAL GLAZE 2.2K 5%	1/10W
R087	1-216-027-00	METAL GLAZE 120 5%	1/10W	R321	1-216-023-00	METAL GLAZE 82 5%	1/10W
R094	1-216-077-00	METAL GLAZE 15K 5%	1/10W	R322	1-216-053-00	METAL GLAZE 1.5K 5%	1/10W
R095	1-216-065-00	METAL GLAZE 4.7K 5%	1/10W	R323	1-216-192-00	METAL GLAZE 560 5%	1/8W
R096	1-216-065-00	METAL GLAZE 4.7K 5%	1/10W	R324	1-216-065-00	METAL GLAZE 4.7K 5%	1/10W
R097	1-216-085-00	METAL GLAZE 33K 5%	1/10W	R325	1-249-410-11	CARBON 270 5%	1/4W
R099	1-216-228-00	METAL GLAZE 18K 5%	1/8W				

For Service Manuals Contact  
**MAURITRON TECHNICAL SERVICES**  
 8 Cherry Tree Rd, Chinnor  
 Oxon OX9 4QY  
 Tel: 01844-351894 Fax: 01844-352554  
 Email: enquiries@mauritron.co.uk

The components identified by shading and mark  $\Delta$  are critical for safety. Replace only with part number specified.

**A**

REF. NO.	PART NO.	DESCRIPTION	REMARK	REF. NO.	PART NO.	DESCRIPTION	REMARK
R326	1-216-035-00	METAL GLAZE 270 5%	1/10W	R508	1-215-867-00	METAL OXIDE 470 5%	1W
R327	1-216-121-00	METAL GLAZE 1M 5%	1/10W	R510	1-216-061-00	METAL GLAZE 3.3K 5%	1/10W
R328	1-216-001-00	METAL GLAZE 10 5%	1/10W	R511	1-216-244-00	METAL GLAZE 82K 5%	1/8W
R329	1-216-109-00	METAL GLAZE 330K 5%	1/10W	R512	1-216-089-00	METAL GLAZE 47K 5%	1/10W
R330	1-216-244-00	METAL GLAZE 82K 5%	1/8W	R513	1-216-053-00	METAL GLAZE 1.5K 5%	1/10W
R331	1-216-113-00	METAL GLAZE 470K 5%	1/10W	R514	1-216-051-00	METAL GLAZE 1.2K 5%	1/10W
R332	1-216-270-00	METAL GLAZE 1M 5%	1/8W	R515	1-216-683-11	METAL CHIP 22K 0.50%	1/10W
R333	1-216-091-00	METAL GLAZE 56K 5%	1/10W	R516	1-216-095-00	METAL GLAZE 82K 5%	1/10W
R334	1-216-067-00	METAL GLAZE 5.6K 5%	1/10W	R517	1-216-035-00	METAL GLAZE 270 5%	1/10W
R335	1-216-001-00	METAL GLAZE 10 5%	1/10W	R518	1-216-033-00	METAL GLAZE 220 5%	1/10W
R336	1-216-059-00	METAL GLAZE 2.7K 5%	1/10W	R519	1-216-049-00	METAL GLAZE 1K 5%	1/10W
R337	1-216-073-00	METAL GLAZE 10K 5%	1/10W	R520	1-216-258-00	METAL GLAZE 330K 5%	1/8W
R338	1-216-073-00	METAL GLAZE 10K 5%	1/10W	R521	1-216-053-00	METAL GLAZE 1.5K 5%	1/10W
R344	1-247-848-11	CARBON 5.1K 5%	1/4W	R522	1-215-863-11	METAL OXIDE 100 5%	1W
R345	1-216-073-00	METAL GLAZE 10K 5%	1/10W	R523	1-247-754-11	CARBON 1.5K 5%	1/2W
R347	1-216-089-00	METAL GLAZE 47K 5%	1/10W	R524	1-216-099-00	METAL GLAZE 120K 5%	1/10W
R348	1-216-033-00	METAL GLAZE 220 5%	1/10W	R525	1-216-065-00	METAL GLAZE 4.7K 5%	1/10W
R349	1-216-029-00	METAL GLAZE 150 5%	1/10W	R527	1-215-869-11	METAL OXIDE 1K 5%	1W
R350	1-216-041-00	METAL GLAZE 470 5%	1/10W	R532	1-216-081-00	METAL GLAZE 22K 5%	1/10W
R351	1-216-043-00	METAL GLAZE 560 5%	1/10W	R533	1-216-133-00	METAL GLAZE 3.3M 5%	1/10W
R352	1-216-039-00	METAL GLAZE 390 5%	1/10W	R534	1-216-069-00	METAL GLAZE 6.8K 5%	1/10W
R353	1-249-438-11	CARBON 56K 5%	1/4W	R535	1-216-107-00	METAL GLAZE 270K 5%	1/10W
R354	1-216-081-00	METAL GLAZE 22K 5%	1/10W	R539	1-216-049-00	METAL GLAZE 1K 5%	1/10W
R355	1-216-049-00	METAL GLAZE 1K 5%	1/10W	R542	1-216-025-00	METAL GLAZE 100 5%	1/10W
R356	1-216-041-00	METAL GLAZE 470 5%	1/10W	R543	1-249-408-11	CARBON 180 5%	1/4W
R357	1-216-039-00	METAL GLAZE 390 5%	1/10W	R545	1-216-278-00	METAL GLAZE 2.2M 5%	1/8W
R358	1-216-089-00	METAL GLAZE 47K 5%	1/10W	R548	1-216-049-00	METAL GLAZE 1K 5%	1/10W
R359	1-216-238-00	METAL GLAZE 47K 5%	1/8W	R601 $\Delta$	1-205-909-11	WIREWOUND 3.3 5%	10W F
R363	1-216-222-00	METAL GLAZE 10K 5%	1/8W	R602	1-214-923-00	CARBON 270K 5%	1/2W
R364	1-216-222-00	METAL GLAZE 10K 5%	1/8W	R603	1-215-903-11	METAL OXIDE 68K 5%	2W
R402	1-216-172-00	METAL GLAZE 82 5%	1/8W	R604	1-247-752-11	CARBON 1K 5%	1/2W
R403	1-216-023-00	METAL GLAZE 82 5%	1/10W	R605 $\Delta$	1-218-265-91	METAL GLAZE 8.2M 5%	1W
R404	1-216-023-00	METAL GLAZE 82 5%	1/10W	R606	1-212-877-11	FUSIBLE 68 5%	1/4W
R405	1-216-023-00	METAL GLAZE 82 5%	1/10W	R608	1-215-884-11	METAL OXIDE 47 5%	2W
R406	1-216-226-00	METAL GLAZE 15K 5%	1/8W	R609	1-207-905-00	WIREWOUND 0.27 10%	2W
R407	1-216-226-00	METAL GLAZE 15K 5%	1/8W	R611	1-214-915-00	CARBON 120K 5%	1/2W
R408	1-216-091-00	METAL GLAZE 56K 5%	1/10W	R612	1-219-137-11	FUSIBLE 0.33 5%	1/4W
R409	1-216-023-00	METAL GLAZE 82 5%	1/10W	R613	1-217-811-11	FUSIBLE 0.47 5%	1/4W
R411	1-216-037-00	METAL GLAZE 330 5%	1/10W	R614	1-216-037-00	METAL GLAZE 330 5%	1/10W
R412	1-216-037-00	METAL GLAZE 330 5%	1/10W	R615	1-216-013-00	METAL GLAZE 33 5%	1/10W
R413	1-216-037-00	METAL GLAZE 330 5%	1/10W	R617	1-216-354-11	METAL OXIDE 2.7 5%	1W F
R414	1-216-041-00	METAL GLAZE 470 5%	1/10W	R620	1-216-465-11	METAL OXIDE 27K 5%	2W
R420	1-216-182-00	METAL GLAZE 220 5%	1/8W	R621	1-216-465-11	METAL OXIDE 27K 5%	2W
R421	1-216-449-11	METAL OXIDE 56 5%	2W	R801	1-217-778-11	FUSIBLE 1K 5%	1W F
R423	1-216-095-00	METAL GLAZE 82K 5%	1/10W	R802	1-217-826-11	FUSIBLE 10K 5%	1/4W F
R424	1-216-073-00	METAL GLAZE 10K 5%	1/10W	R803	1-216-355-11	METAL OXIDE 3.3 5%	1W F
R425	1-216-033-00	METAL GLAZE 220 5%	1/10W	R804	1-216-013-00	METAL GLAZE 33 5%	1/10W
R426	1-216-045-00	METAL GLAZE 680 5%	1/10W	R805	1-216-065-00	METAL GLAZE 4.7K 5%	1/10W
R427	1-216-049-00	METAL GLAZE 1K 5%	1/10W	R806	1-216-049-00	METAL GLAZE 1K 5%	1/10W
R428	1-216-073-00	METAL GLAZE 10K 5%	1/10W	R807	1-216-069-00	METAL GLAZE 6.8K 5%	1/10W
R430	1-216-077-00	METAL GLAZE 15K 5%	1/10W	R808	1-216-091-00	METAL GLAZE 56K 5%	1/10W
R431	1-216-077-00	METAL GLAZE 15K 5%	1/10W	R809	1-216-083-00	METAL GLAZE 27K 5%	1/10W
R432	1-249-403-11	CARBON 68 5%	1/4W	R810	1-216-095-00	METAL GLAZE 82K 5%	1/10W
R433	1-216-079-00	METAL GLAZE 18K 5%	1/10W	R811	1-216-099-00	METAL GLAZE 120K 5%	1/10W
R434	1-216-029-00	METAL GLAZE 150 5%	1/10W	R812	1-217-778-11	FUSIBLE 1K 5%	1W F
R435	1-216-033-00	METAL GLAZE 220 5%	1/10W	R813	1-212-877-11	FUSIBLE 68 5%	1/4W
R436	1-216-089-00	METAL GLAZE 47K 5%	1/10W	R814	1-217-820-11	FUSIBLE 3.3K 5%	1/4W
R437	1-216-085-00	METAL GLAZE 33K 5%	1/10W	R816	1-247-889-00	CARBON 270K 5%	1/4W
R501	1-216-214-00	METAL GLAZE 4.7K 5%	1/8W	R817	1-216-071-00	METAL GLAZE 8.2K 5%	1/10W
R502	1-247-743-11	CARBON 220 5%	1/2W	R818	1-202-830-00	SOLID 10K 10%	1/2W
R503	1-249-437-11	CARBON 47K 5%	1/4W	R819	1-217-811-11	FUSIBLE 0.47 5%	1/4W
R504	1-216-017-00	METAL GLAZE 47 5%	1/10W	R820	1-217-811-11	FUSIBLE 0.47 5%	1/4W
R505	1-216-073-00	METAL GLAZE 10K 5%	1/10W	R821	1-216-059-00	METAL GLAZE 2.7K 5%	1/10W
R507	1-216-350-11	METAL OXIDE 1.2 5%	1W F				

The components identified by shading and mark **A** are critical for safety.  
Replace only with part number specified.



REF.NO.	PART NO.	DESCRIPTION	REMARK
R822	1-216-204-00	METAL GLAZE 1.8K 5%	1/8W
R824	1-215-863-11	METAL OXIDE 100 5%	1W F
R826	1-216-025-00	METAL GLAZE 100 5%	1/10W
R827	1-216-081-00	METAL GLAZE 22K 5%	1/10W F
R850	1-215-882-00	METAL OXIDE 22 5%	2W F
R851	1-247-895-00	CARBON 470K 5%	1/4W
<VARIABLE RESISTOR>			
RV001	1-238-012-11	RES. ADJ. CARBON 1K	
RV501	1-238-016-11	RES. ADJ. CARBON 10K	
RV502	1-226-703-11	RES. ADJ. METAL GLAZE 10K	
RV503	1-238-019-11	RES. ADJ. CARBON 47K	
RV504	1-238-019-11	RES. ADJ. CARBON 47K	
RV505	1-238-009-11	RES. ADJ. CARBON 220	
RV801	1-238-019-11	RES. ADJ. CARBON 47K	
<SWITCH>			
S001	1-571-532-21	SWITCH, TACTIL	
S002	1-571-532-21	SWITCH, TACTIL	
S003	1-571-532-21	SWITCH, TACTIL	
S601	A 1-571-433-12	SWITCH, PUSH (AC POWER)	
<SPARK GAP>			
SG801	1-519-422-11	GAP, SPARK	
<TRANSFORMER>			
T601	A 1-450-217-22	S.R.T	
T604	A 1-424-078-11	TRANSFORMER, TRIGGER PULSE	
T605	A 1-421-862-11	LFT	
T801	1-437-090-00	HDT	
T802	A 1-439-432-11	TRANSFORMER ASSY, FLYBACK (UX-1620)	
<THERMISTOR>			
THP601A	1-806-165-12	THERMISTOR (POSITIVE)	
<TUNER>			
TU101A	1-465-542-11	TUNER, UHF (BT-3U601)	
<CRYSTAL>			
X001	1-577-619-11	VIBRATOR, CRYSTAL	
X332	1-567-131-00	OSCILLATOR, CRYSTAL	
*****			
*A-1638-008-A	C BOARD, COMPLETE		
*****			
*4-374-912-01	COVER (MAIN), CV VOL		
*4-374-913-01	COVER (REAR LID), CV VOL		
<CAPACITOR>			
C700	1-137-146-11	FILM 0.15MF	10% 250V
C701	1-163-127-00	CERAMIC CHIP 270PF	5% 50V
C702	1-163-127-00	CERAMIC CHIP 270PF	5% 50V
C703	1-163-129-00	CERAMIC CHIP 330PF	5% 50V
C704	1-163-005-11	CERAMIC CHIP 470PF	10% 50V
C705	1-163-005-11	CERAMIC CHIP 470PF	10% 50V

REF.NO.	PART NO.	DESCRIPTION	REMARK
C706	1-163-005-11	CERAMIC CHIP 470PF	10% 50V
C707	1-123-947-00	ELECT 10MF	20% 250V
C708	1-162-116-00	CERAMIC 680PF	10% 2KV
C709	1-136-666-11	FILM 0.01MF	5% 1KV
C710	1-124-477-11	ELECT 47MF	20% 16V
C711	1-163-009-11	CERAMIC CHIP 0.001MF	10% 50V
C712	1-163-009-11	CERAMIC CHIP 0.001MF	10% 50V
C713	1-163-009-11	CERAMIC CHIP 0.001MF	10% 50V
C714	1-162-318-11	CERAMIC 0.001MF	10% 500V
<CONNECTOR>			
CNC71	*1-508-786-00	PIN, CONNECTOR (5MM PITCH) 2P	
CNC72	*1-560-123-00	PLUG, CONNECTOR (2.5MM) 3P	
CNC73	*1-568-881-51	PIN, CONNECTOR 6P	
CNC74	*1-508-765-00	PIN, CONNECTOR (5MM PITCH) 3P	
<DIODE>			
D701	8-719-400-18	DIODE MA152WK	
D702	8-719-400-18	DIODE MA152WK	
D703	8-719-400-18	DIODE MA152WK	
D704	8-719-400-18	DIODE MA152WK	
D705	8-719-400-18	DIODE MA152WK	
D706	8-719-911-19	DIODE 1SS119	
D707	8-719-400-18	DIODE MA152WK	
D708	8-719-400-18	DIODE MA152WK	
D709	8-719-400-18	DIODE MA152WK	
D710	8-719-800-76	DIODE 1SS226	
D711	8-719-800-76	DIODE 1SS226	
D712	8-719-800-76	DIODE 1SS226	
<JACK>			
J901	1-526-819-11	SOCKET, PICTURE TUBE	
<TRANSISTOR>			
Q701	8-729-230-49	TRANSISTOR 2SC2712-YG	
Q702	8-729-230-49	TRANSISTOR 2SC2712-YG	
Q703	8-729-230-49	TRANSISTOR 2SC2712-YG	
Q704	8-729-906-70	TRANSISTOR BF871	
Q705	8-729-906-70	TRANSISTOR BF871	
Q706	8-729-906-70	TRANSISTOR BF871	
Q707	8-729-200-17	TRANSISTOR 2SA1091-0	
Q708	8-729-200-17	TRANSISTOR 2SA1091-0	
Q709	8-729-200-17	TRANSISTOR 2SA1091-0	
<RESISTOR>			
JW121	1-216-296-00	METAL GLAZE 0	5% 1/8W
R701	1-216-061-00	METAL GLAZE 3.3K	5% 1/10W
R702	1-216-210-00	METAL GLAZE 3.3K	5% 1/8W
R703	1-216-045-00	METAL GLAZE 680	5% 1/10W
R704	1-216-045-00	METAL GLAZE 680	5% 1/10W
R705	1-216-017-00	METAL GLAZE 47	5% 1/10W
R706	1-216-017-00	METAL GLAZE 47	5% 1/10W
R707	1-216-017-00	METAL GLAZE 47	5% 1/10W
R708	1-216-198-00	METAL GLAZE 1K	5% 1/8W
R709	1-216-196-00	METAL GLAZE 820	5% 1/8W
R710	1-249-413-11	CARBON 470	5% 1/4W
R711	1-216-061-00	METAL GLAZE 3.3K	5% 1/10W
R712	1-247-893-11	CARBON 390K	5% 1/4W
R713	1-247-883-00	CARBON 150K	5% 1/4W
R714	1-216-198-00	METAL GLAZE 1K	5% 1/8W

For Service Manuals  
**MAURITRON SERVICES S**  
 8 Cherry Tree Road, Chinnor  
 Oxfordshire, OX9 4QY.  
 Tel (01844) 351694  
 Fax (01844) 352654  
 email: - mauritron@dial.pipex.com

C

V

The components identified by shading and mark  $\Delta$  are critical for safety.  
Replace only with part number specified.

REF. NO.	PART NO.	DESCRIPTION	REMARK	REF. NO.	PART NO.	DESCRIPTION	REMARK
R715	1-216-198-00	METAL GLAZE 1K 5%	1/8W	C57	1-163-117-00	CERAMIC CHIP 100PF 5%	50V
R716	1-216-049-00	METAL GLAZE 1K 5%	1/10W	C58	1-163-117-00	CERAMIC CHIP 100PF 5%	50V
R717	1-202-824-00	SOLID 3.3K 10%	1/2W	<CONNECTOR>			
R718	1-202-824-00	SOLID 3.3K 10%	1/2W	CNV01	*1-565-393-11	CONNECTOR, BOARD TO BOARD	
R719	1-202-824-00	SOLID 3.3K 10%	1/2W	CNV02	*1-565-393-11	CONNECTOR, BOARD TO BOARD	
R720	1-216-463-00	METAL OXIDE 12K 5%	2W	CNV03	*1-508-784-00	PIN, CONNECTOR (5MM PITCH) 1P	
R721	1-216-463-00	METAL OXIDE 12K 5%	2W	<TRIMMER>			
R722	1-216-463-00	METAL OXIDE 12K 5%	2W	CT01	1-141-392-11	CAP, VAR, TRIMMER (1 GANG)	
R723	1-249-398-11	CARBON 27 5%	1/4W F	<DIODE>			
R726	1-202-719-00	SOLID 1M 10%	1/2W	D01	8-719-105-91	DIODE RD5.6M-B2	
R727	1-202-838-00	SOLID 100K 10%	1/2W	D02	8-719-106-79	DIODE RD13M-B1	
R728	1-202-842-11	SOLID 220K 10%	1/2W	D03	8-719-400-18	DIODE MA152WK	
R729	1-216-349-00	METAL OXIDE 1 5%	1W F	D07	8-719-106-17	DIODE RD6.8M-B2	
R731	1-202-719-00	SOLID 1M 10%	1/2W	D08	8-719-106-17	DIODE RD6.8M-B2	
R732	1-216-262-00	METAL GLAZE 470K 5%	1/8W	D11	8-719-914-44	DIODE DAP202K	
R734	1-216-057-00	METAL GLAZE 2.2K 5%	1/10W	<IC>			
R735	1-216-057-00	METAL GLAZE 2.2K 5%	1/10W	IC2	8-759-037-64	IC SDA5231-2	
R736	1-249-421-11	CARBON 2.2K 5%	1/4W	IC3	8-759-503-42	IC SAA5243P/E/W3	
<VARIABLE RESISTOR>				IC4	8-759-510-49	IC FCB61C65L-70P	
RV701	1-237-749-11	RES, ADJ, CARBON 2200		<COIL>			
RV702	1-237-749-11	RES, ADJ, CARBON 2200		L01	1-408-411-00	INDUCTOR 15UH	
RV703	1-230-641-11	RES, ADJ, METAL GLAZE 2.2M		L04	1-408-407-00	INDUCTOR 6.8UH	
RV704	1-230-641-11	RES, ADJ, METAL GLAZE 2.2M		L05	1-408-407-00	INDUCTOR 6.8UH	
RV705	1-230-798-11	RES, ADJ, METAL GLAZE 90M		L06	1-408-407-00	INDUCTOR 6.8UH	
*****				<IC LINK>			
*A-1645-012-A V BOARD, COMPLETE (KV-M1411U ONLY)				PS01	$\Delta$ 1-532-679-91	LINK, IC (ICP-N15) 0.6A	
*****				PS02	$\Delta$ 1-532-727-91	LINK, IC 0.25A	
*4-380-699-01 CASE (UPPER LID), SHIELD, A1				<TRANSISTOR>			
<CAPACITOR>				Q01	8-729-920-92	TRANSISTOR 2SD2096-EF	
C01	1-124-119-00	ELECT 330MF 20%	16V	Q02	8-729-807-50	TRANSISTOR 2SD1623-R	
C02	1-124-120-11	ELECT 220MF 20%	16V	Q03	8-729-923-80	TRANSISTOR DTC143EK	
C03	1-124-119-00	ELECT 330MF 20%	16V	Q04	8-729-230-49	TRANSISTOR 2SC2712-YG	
C05	1-126-101-11	ELECT 100MF 20%	16V	Q05	8-729-807-50	TRANSISTOR 2SD1623-R	
C06	1-124-120-11	ELECT 220MF 20%	16V	Q07	8-729-900-98	TRANSISTOR DTC143TK	
C07	1-130-834-00	MYLAR 1MF 10%	63V	Q09	8-729-807-87	TRANSISTOR 2SB1295-UL6	
C08	1-163-097-00	CERAMIC CHIP 15PF 5%	50V	Q10	8-729-807-87	TRANSISTOR 2SB1295-UL6	
C09	1-163-141-00	CERAMIC CHIP 0.001MF 5%	50V	Q11	8-729-807-87	TRANSISTOR 2SB1295-UL6	
C10	1-163-133-00	CERAMIC CHIP 470PF 5%	50V	<RESISTOR>			
C11	1-163-037-11	CERAMIC CHIP 0.022MF 10%	25V	JW1	1-216-295-00	METAL GLAZE 0 5%	1/10W
C12	1-163-127-00	CERAMIC CHIP 270PF 5%	50V	JW2	1-216-295-00	METAL GLAZE 0 5%	1/10W
C13	1-163-117-00	CERAMIC CHIP 100PF 5%	50V	JW3	1-216-295-00	METAL GLAZE 0 5%	1/10W
C14	1-163-097-00	CERAMIC CHIP 15PF 5%	50V	JW4	1-216-295-00	METAL GLAZE 0 5%	1/10W
C15	1-163-103-00	CERAMIC CHIP 27PF 5%	50V	JW5	1-216-295-00	METAL GLAZE 0 5%	1/10W
C16	1-164-232-11	CERAMIC CHIP 0.01MF 10%	50V	JW6	1-216-295-00	METAL GLAZE 0 5%	1/10W
C17	1-163-809-11	CERAMIC CHIP 0.047MF 10%	25V	JW7	1-216-295-00	METAL GLAZE 0 5%	1/10W
C18	1-163-099-00	CERAMIC CHIP 18PF 5%	50V	JW8	1-216-295-00	METAL GLAZE 0 5%	1/10W
C19	1-163-809-11	CERAMIC CHIP 0.047MF 10%	25V	JW9	1-216-295-00	METAL GLAZE 0 5%	1/10W
C20	1-163-125-00	CERAMIC CHIP 220PF 5%	50V	JW10	1-216-295-00	METAL GLAZE 0 5%	1/10W
C21	1-163-833-00	CERAMIC CHIP 0.068MF 25V					
C24	1-126-101-11	ELECT 100MF 20%	16V				
C25	1-124-477-11	ELECT 47MF 20%	16V				
C27	1-163-129-00	CERAMIC CHIP 330PF 5%	50V				
C28	1-163-137-00	CERAMIC CHIP 680PF 5%	50V				
C51	1-163-038-00	CERAMIC CHIP 0.1MF 25V					
C52	1-163-038-00	CERAMIC CHIP 0.1MF 25V					
C53	1-163-038-00	CERAMIC CHIP 0.1MF 25V					
C54	1-163-038-00	CERAMIC CHIP 0.1MF 25V					
C55	1-163-038-00	CERAMIC CHIP 0.1MF 25V					
C56	1-163-038-00	CERAMIC CHIP 0.1MF 25V					



The components identified by shading and mark  $\Delta$  are critical for safety. Replace only with part number specified.

REF. NO.	PART NO.	DESCRIPTION	REMARK
JW11	1-216-295-00	METAL GLAZE 0 5% 1/10W	
JW12	1-216-295-00	METAL GLAZE 0 5% 1/10W	
JW13	1-216-295-00	METAL GLAZE 0 5% 1/10W	
JW14	1-216-295-00	METAL GLAZE 0 5% 1/10W	
JW15	1-216-295-00	METAL GLAZE 0 5% 1/10W	
JW16	1-216-295-00	METAL GLAZE 0 5% 1/10W	
JW17	1-216-295-00	METAL GLAZE 0 5% 1/10W	
JW18	1-216-295-00	METAL GLAZE 0 5% 1/10W	
JW19	1-216-295-00	METAL GLAZE 0 5% 1/10W	
JW20	1-216-295-00	METAL GLAZE 0 5% 1/10W	
JW21	1-216-295-00	METAL GLAZE 0 5% 1/10W	
JW22	1-216-295-00	METAL GLAZE 0 5% 1/10W	
JW23	1-216-295-00	METAL GLAZE 0 5% 1/10W	
JW24	1-216-295-00	METAL GLAZE 0 5% 1/10W	
JW25	1-216-295-00	METAL GLAZE 0 5% 1/10W	
R01	1-218-326-11	METAL GLAZE 470 5% 1/2W	
R02	1-216-049-00	METAL GLAZE 1K 5% 1/10W	
R04	1-218-326-11	METAL GLAZE 470 5% 1/2W	
R05	1-216-025-00	METAL GLAZE 100 5% 1/10W	
R06	1-216-049-00	METAL GLAZE 1K 5% 1/10W	
R07	1-216-025-00	METAL GLAZE 100 5% 1/10W	
R08	1-216-037-00	METAL GLAZE 330 5% 1/10W	
R09	1-216-091-00	METAL GLAZE 56K 5% 1/10W	
R13	1-216-025-00	METAL GLAZE 100 5% 1/10W	
R14	1-216-025-00	METAL GLAZE 100 5% 1/10W	
R19	1-216-037-00	METAL GLAZE 330 5% 1/10W	
R20	1-216-063-00	METAL GLAZE 3.9K 5% 1/10W	
R27	1-216-013-00	METAL GLAZE 33 5% 1/10W	
R28	1-216-013-00	METAL GLAZE 33 5% 1/10W	
R29	1-216-013-00	METAL GLAZE 33 5% 1/10W	
R30	1-218-325-11	METAL GLAZE 120 5% 1/4W	
R31	1-218-325-11	METAL GLAZE 120 5% 1/4W	
R32	1-218-325-11	METAL GLAZE 120 5% 1/4W	
R33	1-216-023-00	METAL GLAZE 82 5% 1/10W	
R34	1-216-049-00	METAL GLAZE 1K 5% 1/10W	
R37	1-216-025-00	METAL GLAZE 100 5% 1/10W	
R38	1-216-047-00	METAL GLAZE 820 5% 1/10W	
R45	1-216-049-00	METAL GLAZE 1K 5% 1/10W	
R46	1-216-311-00	METAL GLAZE 6.8 5% 1/10W	
R51	1-216-065-00	METAL GLAZE 4.7K 5% 1/10W	
R52	1-216-065-00	METAL GLAZE 4.7K 5% 1/10W	
R53	1-216-065-00	METAL GLAZE 4.7K 5% 1/10W	
R54	1-216-065-00	METAL GLAZE 4.7K 5% 1/10W	
R55	1-216-057-00	METAL GLAZE 2.2K 5% 1/10W	

<VARIABLE RESISTOR>

RV01	1-238-012-11	RES. ADJ, CARBON 1K
------	--------------	---------------------

<CRYSTAL>

X01	1-567-162-00	OSCILLATOR, CRYSTAL
X02	1-567-495-11	OSCILLATOR, CRYSTAL

REF. NO.	PART NO.	DESCRIPTION	REMARK
		MISCELLANEOUS	
		*****	
	$\Delta$ 1-426-145-21	COIL, DEGAUSSING	
	$\Delta$ 1-451-249-31	DEFLECTION YOKE (Y14NDA2)	
	1-452-032-00	MAGNET, DISK; 10MM $\phi$	
	1-452-094-00	MAGNET, ROTATABLE DISK; 15MM $\phi$	
	1-452-277-00	MAGNET, BMC	
	1-544-374-11	SPEAKER	
	$\Delta$ 1-575-807-11	CORD, POWER (WITH CONNECTOR)	
V901	$\Delta$ 8-735-555-75	PICTURE TUBE (A34JBU10X)	

\*\*\*\*\*

ACCESSORIES AND PACKING MATERIALS

PART NO.	DESCRIPTION	REMARK
1-417-154-11	MATCHING TRANSFORMER, ANTENNA	
1-501-385-11	ANTENNA, ROOP	
*4-200-423-01	CUSHION (LOWER) (ASSY)	
*4-200-424-01	CUSHION (UPPER) (ASSY)	
*4-200-426-01	INDIVIDUAL CARTON	
*4-384-927-01	BAG, PROTECTION	
4-200-981-51	MANUAL, INSTRUCTION (ENGLISH)	
REMOTE COMMANDER		
1-465-562-12	CONTROL UNIT, REMOTE (RM-694)	
4-035-049-01	COVER, BATTERY (FOR RM-694)	

For Service Manuals Contact MAURITRON TECHNICAL SERVICES 8 Cherry Tree Rd, Chinnor Oxon OX9 4QY Tel: 01844-351694 Fax: 01844-352554 Email: enquires@mauritron.co.uk

9-964-792-01

**Sony Corporation**  
TV Group

—36—

**English**  
92BU0417-1  
Printed in Japan  
© 1992. 2