



三洋半導体ニュース

No. N7411

62503

新

SBFP420M — NPN エピタキシャルプレーナ型シリコントランジスタ

UHF ~ C バンド低雑音増幅、低位相雑音発振用

- 特長**
- ・低雑音である : $NF=1.1\text{dB typ}(f=1.8\text{GHz})$
 - ・しゃ断周波数が高い : $f_T=18\text{GHz typ}(V_{CE}=1\text{V})$
: $f_T=25\text{GHz typ}(V_{CE}=3\text{V})$
 - ・低電圧動作。
 - ・高利得である : $|S_{21e}|^2=17\text{dB typ}(f=1.8\text{GHz})$

絶対最大定格 Absolute Maximum Ratings / Ta=25

			unit
コレクタ・ベース電圧	V_{CBO}	15	V
コレクタ・エミッタ電圧	V_{CEO}	4.5	V
エミッタ・ベース電圧	V_{EBO}	1.5	V
コレクタ電流	I_C	35	mA
コレクタ損失	P_C	160	mW
接合部温度	T_j	150	
保存周囲温度	T_{stg}	- 55 ~ + 150	

電気的特性 Electrical Characteristics / Ta=25

			min	typ	max	unit
コレクタしゃ断電流	I_{CBO}	$V_{CB}=5\text{V}, I_E=0$			200	nA
エミッタしゃ断電流	I_{EBO}	$V_{EB}=1.5\text{V}, I_C=0$			35	μA
直流電流増幅率	h_{FE}	$V_{CE}=4\text{V}, I_C=20\text{mA}$	50		150	
利得帯域幅積	f_T1	$V_{CE}=1\text{V}, I_C=10\text{mA}$	13	18		GHz
	f_T2	$V_{CE}=3\text{V}, I_C=30\text{mA}$	18	25		GHz
帰還容量	C_{re}	$V_{CB}=2\text{V}, f=1\text{MHz}$		0.15	0.3	pF
順方向伝達利得	$ S_{21e} ^2_1$	$V_{CE}=2\text{V}, I_C=5\text{mA}, f=1.8\text{GHz}$	12	15		dB
	$ S_{21e} ^2_2$	$V_{CE}=2\text{V}, I_C=20\text{mA}, f=1.8\text{GHz}$	14	17		dB
雑音指数	NF	$V_{CE}=2\text{V}, I_C=5\text{mA}, f=1.8\text{GHz}$		1.1		dB

単体品名表示 : MB

電気的接続図

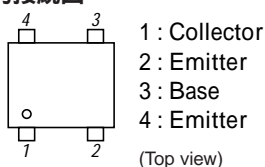

本製品は、高周波プロセスを採用しています。静電気等への影響を受けやすくなっていますので取扱いにご注意下さい。

■本書記載の製品は、極めて高度の信頼性を要する用途(生命維持装置、航空機のコントロールシステム等、多大な人的・物的損害を及ぼす恐れのある用途)に対応する仕様にはなっていません。そのような場合には、あらかじめ三洋電機販売窓口までご相談下さい。

■本書記載の規格値(最大定格、動作条件範囲等)を瞬時たりとも越えて使用し、その結果発生した機器の欠陥について、弊社は責任を負いません。

外形図 2213

(unit : mm)

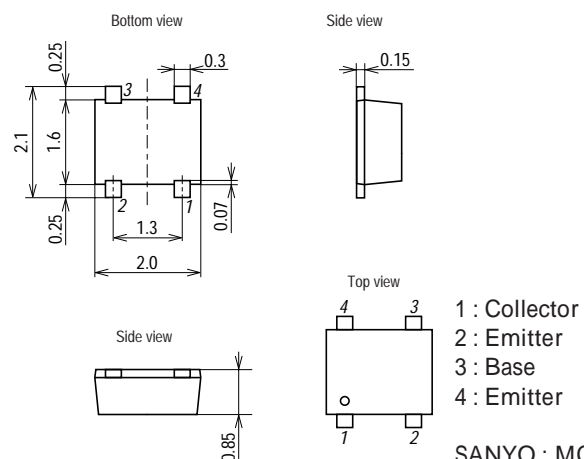

SANYO : MCPH4

SBPF420M

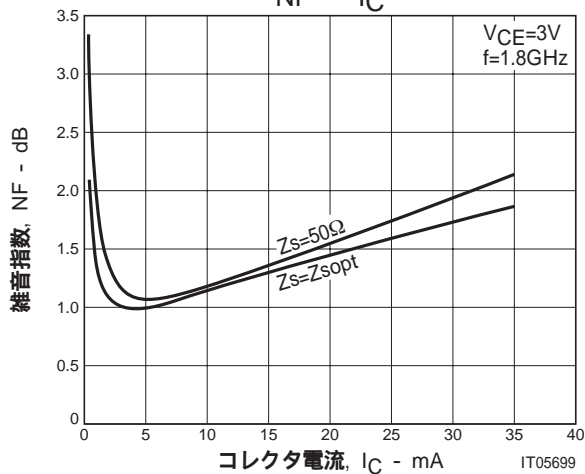
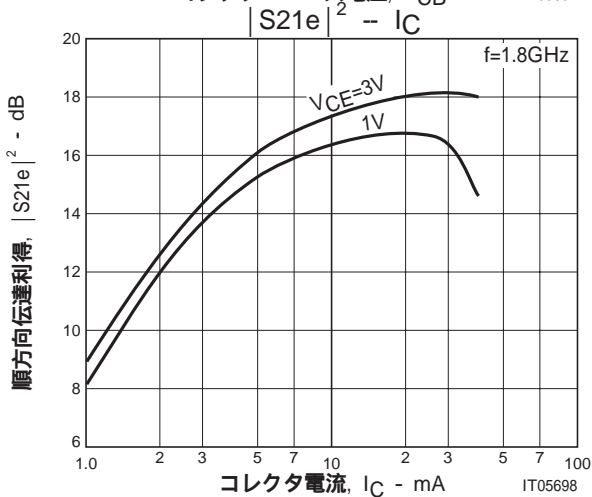
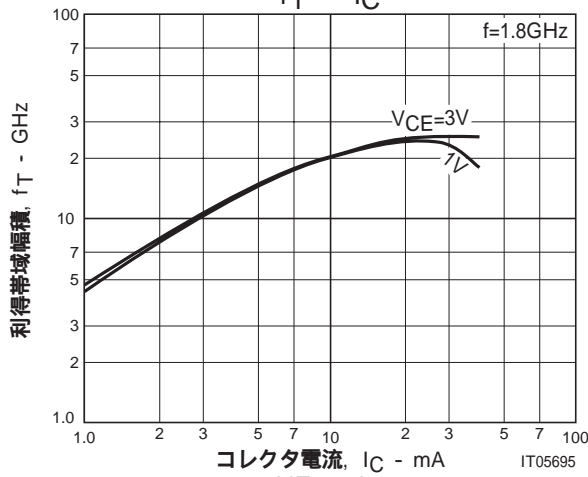
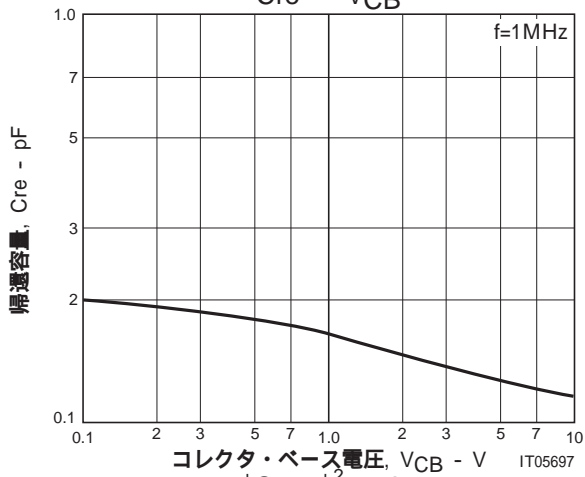
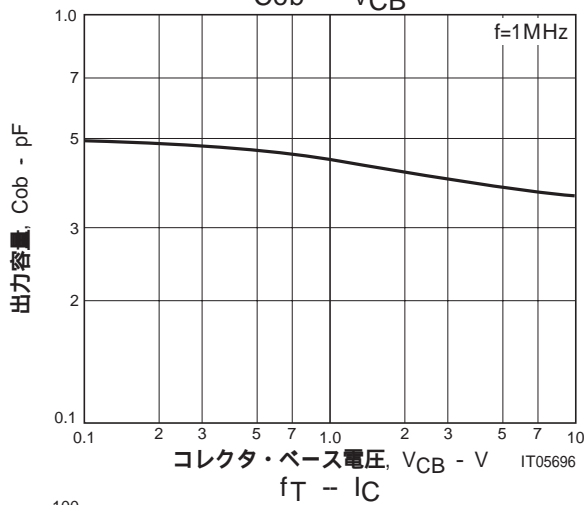
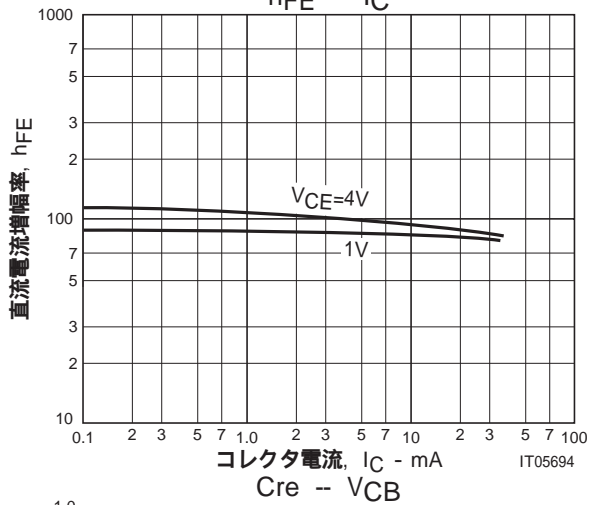
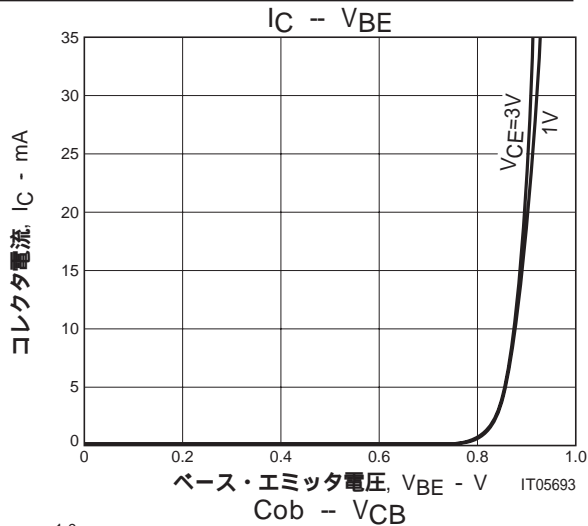
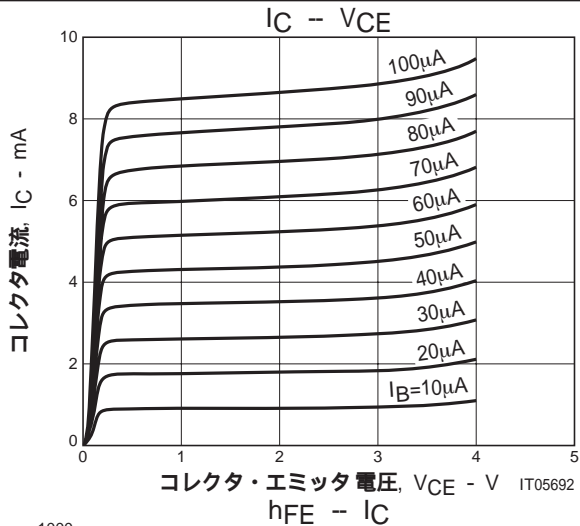

SBPF420M

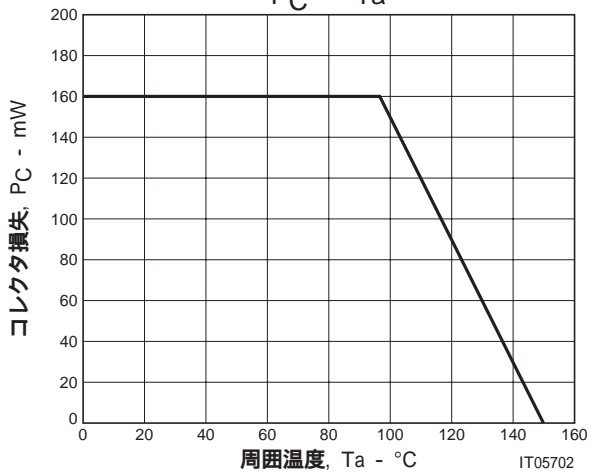
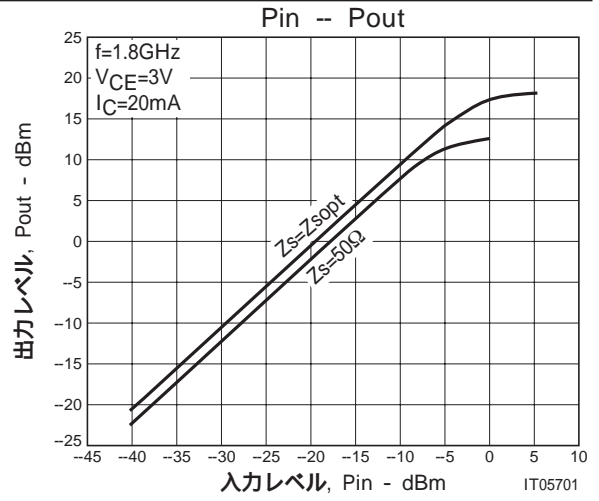
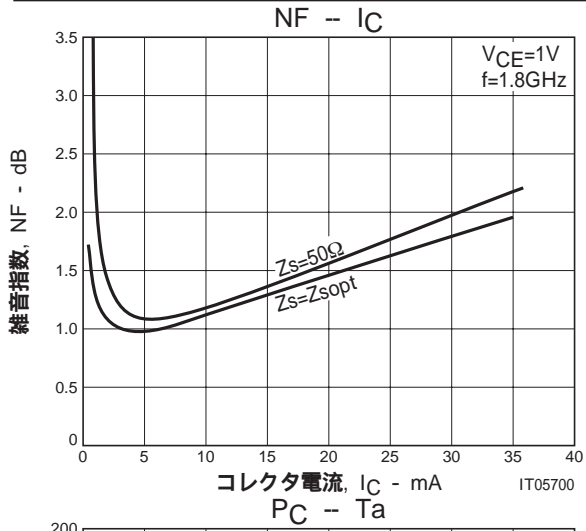

SBPF420M

S パラメータ (エミッタ接地)

$V_{CE}=1V, I_C=5mA, Z_O=50\Omega$

Freq(MHz)	$ S_{11} $	$\angle S_{11}$	$ S_{21} $	$\angle S_{21}$	$ S_{12} $	$\angle S_{12}$	$ S_{22} $	$\angle S_{22}$
200	0.804	-24.9	12.981	160.4	0.021	75.9	0.947	-16.3
400	0.771	-47.6	11.973	144.5	0.040	64.0	0.874	-30.2
600	0.669	-62.9	10.230	130.0	0.050	56.8	0.766	-41.6
800	0.626	-78.4	9.091	120.4	0.060	51.7	0.706	-46.2
1000	0.561	-95.8	7.909	110.4	0.063	45.6	0.621	-49.9
1200	0.533	-107.9	7.153	102.5	0.070	44.0	0.562	-58.7
1400	0.497	-119.2	6.341	96.2	0.076	42.1	0.517	-60.2
1600	0.481	-128.2	5.740	90.7	0.079	41.8	0.496	-63.2
1800	0.457	-136.6	5.200	86.1	0.081	40.8	0.450	-64.1
2000	0.435	-144.4	4.575	81.8	0.087	40.8	0.441	-64.8
2200	0.430	-151.2	4.365	77.4	0.091	40.3	0.411	-69.1
2400	0.433	-156.7	4.088	73.3	0.096	40.1	0.395	-70.4
2600	0.428	-162.7	3.804	68.7	0.101	39.5	0.376	-71.4
2800	0.429	-169.4	3.474	65.2	0.103	38.5	0.363	-72.4
3000	0.434	-176.2	3.371	61.5	0.106	37.2	0.340	-76.5
3200	0.432	178.3	3.197	58.1	0.112	38.1	0.322	-77.9
3400	0.432	173.1	3.015	54.6	0.114	36.6	0.304	-79.5
3600	0.434	168.2	2.872	51.1	0.118	35.3	0.281	-83.5
3800	0.434	164.0	2.743	47.9	0.125	36.0	0.268	-86.7
4000	0.435	160.1	2.608	44.7	0.131	34.0	0.259	-89.6
4200	0.449	155.5	2.512	41.6	0.134	33.9	0.235	-91.6
4400	0.448	151.0	2.413	38.6	0.138	31.9	0.218	-96.4
4600	0.453	147.5	2.318	35.2	0.145	31.6	0.209	-100.3
4800	0.458	143.3	2.242	32.1	0.150	30.0	0.202	-102.7
5000	0.461	138.7	2.170	29.0	0.152	29.3	0.195	-106.9
5200	0.464	135.2	2.072	25.9	0.155	27.6	0.194	-110.1
5400	0.456	131.4	2.009	23.1	0.160	27.3	0.183	-116.7
5600	0.462	128.7	1.912	20.9	0.165	25.1	0.200	-118.1
5800	0.461	125.3	1.890	17.7	0.169	24.9	0.182	-121.6
6000	0.471	121.5	1.843	14.7	0.175	23.2	0.176	-125.8

SBPF420M

S パラメータ (エミッタ接地)

$V_{CE}=1V, I_C=10mA, Z_O=50\Omega$

Freq(MHz)	$ S_{11} $	$\angle S_{11}$	$ S_{21} $	$\angle S_{21}$	$ S_{12} $	$\angle S_{12}$	$ S_{22} $	$\angle S_{22}$
200	0.666	-36.7	21.282	153.7	0.018	71.9	0.900	-23.1
400	0.613	-67.4	18.199	134.0	0.033	61.0	0.769	-40.1
600	0.503	-86.5	14.552	119.0	0.041	54.8	0.637	-51.5
800	0.464	-102.1	12.110	109.8	0.047	53.3	0.566	-54.9
1000	0.428	-120.3	10.116	101.1	0.053	51.9	0.478	-57.0
1200	0.416	-131.3	8.772	94.1	0.058	50.4	0.432	-66.5
1400	0.396	-141.9	7.631	88.4	0.063	50.8	0.391	-67.2
1600	0.389	-149.5	6.801	83.9	0.069	49.5	0.375	-68.7
1800	0.380	-157.1	6.060	79.9	0.074	52.2	0.334	-69.1
2000	0.364	-164.6	5.379	76.2	0.079	50.1	0.325	-69.1
2200	0.362	-169.7	5.051	72.3	0.084	50.8	0.308	-73.2
2400	0.367	-174.0	4.691	68.8	0.092	50.2	0.299	-73.8
2600	0.368	-178.2	4.365	64.8	0.097	49.3	0.278	-75.3
2800	0.375	175.4	4.022	61.7	0.102	48.3	0.269	-76.0
3000	0.380	169.8	3.804	58.0	0.107	47.1	0.258	-80.5
3200	0.384	165.7	3.587	55.0	0.115	46.9	0.243	-80.7
3400	0.387	161.5	3.379	51.9	0.120	44.5	0.224	-83.3
3600	0.392	157.3	3.209	48.9	0.124	43.9	0.206	-88.9
3800	0.393	153.7	3.062	46.0	0.131	43.7	0.188	-92.9
4000	0.398	150.9	2.922	43.2	0.135	40.7	0.177	-97.6
4200	0.412	147.0	2.806	40.3	0.142	40.3	0.160	-99.0
4400	0.411	143.0	2.677	37.2	0.149	39.2	0.142	-106.1
4600	0.420	139.8	2.578	34.5	0.154	37.2	0.134	-110.2
4800	0.426	136.1	2.490	31.5	0.161	35.3	0.133	-113.6
5000	0.431	131.9	2.405	28.3	0.166	34.1	0.124	-119.4
5200	0.429	128.3	2.317	25.6	0.168	32.1	0.121	-125.0
5400	0.426	125.4	2.225	23.1	0.173	30.4	0.116	-132.9
5600	0.431	122.8	2.154	20.8	0.178	28.8	0.125	-132.9
5800	0.429	119.8	2.099	17.7	0.183	27.4	0.110	-139.9
6000	0.437	116.3	2.052	15.1	0.188	26.7	0.113	-142.8

SBPF420M

S パラメータ (エミッタ接地)

V_{CE}=1V, I_C=20mA, Z_O=50Ω

Freq(MHz)	S ₁₁	∠S ₁₁	S ₂₁	∠S ₂₁	S ₁₂	∠S ₁₂	S ₂₂	∠S ₂₂
200	0.493	-58.9	30.235	144.6	0.017	70.2	0.825	-31.0
400	0.459	-95.5	23.050	123.1	0.027	58.7	0.638	-49.7
600	0.375	-116.4	17.288	109.6	0.033	56.8	0.507	-59.3
800	0.358	-129.2	13.786	101.2	0.038	59.8	0.439	-61.2
1000	0.357	-145.8	11.375	94.2	0.047	59.1	0.358	-61.3
1200	0.355	-153.6	9.605	88.2	0.052	59.7	0.330	-70.5
1400	0.352	-161.7	8.247	83.9	0.058	59.4	0.296	-70.4
1600	0.350	-167.7	7.290	79.5	0.065	60.4	0.290	-72.2
1800	0.344	-173.7	6.490	75.9	0.072	59.2	0.257	-70.8
2000	0.342	180.0	5.870	72.6	0.079	59.2	0.249	-72.1
2200	0.341	176.2	5.370	68.7	0.087	58.0	0.238	-75.7
2400	0.343	172.1	4.985	65.5	0.094	56.5	0.230	-76.7
2600	0.345	168.7	4.626	62.3	0.101	53.4	0.214	-77.9
2800	0.353	163.0	4.296	59.0	0.106	53.7	0.205	-78.6
3000	0.360	158.9	4.017	55.7	0.111	52.6	0.193	-83.2
3200	0.362	154.9	3.777	52.7	0.121	51.3	0.182	-82.5
3400	0.368	151.2	3.560	49.9	0.126	49.8	0.164	-84.2
3600	0.375	147.8	3.385	46.9	0.133	48.0	0.147	-92.2
3800	0.377	145.1	3.222	44.2	0.136	46.4	0.136	-96.5
4000	0.381	142.1	3.067	41.4	0.145	45.3	0.130	-102.6
4200	0.400	139.2	2.935	38.7	0.150	43.4	0.115	-107.0
4400	0.403	135.2	2.798	35.9	0.154	41.1	0.102	-116.2
4600	0.409	132.9	2.686	33.0	0.164	39.5	0.095	-125.4
4800	0.416	129.3	2.598	30.2	0.167	38.1	0.094	-130.4
5000	0.424	126.3	2.503	27.5	0.176	35.8	0.088	-139.1
5200	0.430	123.0	2.429	24.7	0.180	34.4	0.083	-144.7
5400	0.427	119.7	2.322	22.2	0.184	31.7	0.084	-154.4
5600	0.431	117.3	2.267	19.8	0.189	30.6	0.091	-155.0
5800	0.434	114.4	2.188	16.9	0.194	28.7	0.088	-163.4
6000	0.440	110.7	2.128	14.1	0.199	26.8	0.085	-169.7

SBPF420M

S パラメータ (エミッタ接地)

V_{CE}=2V, I_C=5mA, Z_O=50Ω

Freq(MHz)	S ₁₁	∠S ₁₁	S ₂₁	∠S ₂₁	S ₁₂	∠S ₁₂	S ₂₂	∠S ₂₂
200	0.808	-22.9	13.475	162.0	0.018	77.4	0.957	-14.0
400	0.778	-44.0	12.480	146.4	0.033	67.0	0.892	-26.0
600	0.690	-60.1	10.781	133.2	0.043	59.1	0.809	-34.0
800	0.643	-75.7	9.675	122.6	0.050	53.7	0.725	-40.9
1000	0.605	-88.8	8.492	113.4	0.057	49.1	0.666	-45.5
1200	0.551	-101.0	7.703	106.2	0.061	47.6	0.617	-49.5
1400	0.523	-110.5	6.894	99.8	0.066	45.8	0.578	-52.9
1600	0.497	-120.1	6.233	93.8	0.070	44.9	0.539	-55.4
1800	0.473	-128.7	5.697	89.0	0.073	44.6	0.510	-57.6
2000	0.455	-136.0	5.052	84.6	0.077	43.6	0.503	-58.5
2200	0.443	-143.3	4.817	79.9	0.081	43.4	0.467	-61.0
2400	0.433	-150.2	4.472	75.8	0.084	42.7	0.448	-62.3
2600	0.424	-156.0	4.124	71.6	0.088	42.9	0.434	-62.7
2800	0.417	-162.1	3.801	68.4	0.092	41.7	0.425	-63.9
3000	0.412	-169.8	3.706	64.7	0.096	41.8	0.394	-66.8
3200	0.411	-175.7	3.498	61.1	0.099	41.5	0.377	-68.3
3400	0.411	178.3	3.322	57.7	0.103	41.2	0.363	-69.6
3600	0.413	172.6	3.158	54.5	0.108	40.9	0.349	-71.3
3800	0.416	167.5	3.015	51.2	0.112	40.0	0.334	-72.9
4000	0.424	162.9	2.879	48.1	0.116	39.6	0.321	-75.2
4200	0.431	157.6	2.760	44.9	0.119	38.7	0.306	-77.4
4400	0.436	152.7	2.658	41.7	0.124	37.8	0.292	-79.8
4600	0.445	148.4	2.550	38.7	0.128	37.2	0.281	-82.1
4800	0.452	144.4	2.457	35.7	0.132	35.9	0.270	-84.5
5000	0.455	140.3	2.373	32.8	0.136	35.1	0.260	-87.2
5200	0.464	137.2	2.260	29.9	0.139	34.0	0.261	-89.9
5400	0.467	133.1	2.214	27.0	0.144	33.3	0.247	-93.0
5600	0.475	130.1	2.098	24.6	0.148	32.1	0.259	-96.3
5800	0.477	127.0	2.073	21.4	0.153	30.7	0.243	-99.2
6000	0.479	123.1	2.021	18.5	0.157	29.4	0.239	-102.3

SBPF420M

S パラメータ (エミッタ接地)

$V_{CE}=2V$, $I_C=10mA$, $Z_O=50\Omega$

Freq(MHz)	$ S_{11} $	$\angle S_{11}$	$ S_{21} $	$\angle S_{21}$	$ S_{12} $	$\angle S_{12}$	$ S_{22} $	$\angle S_{22}$
200	0.672	-33.0	22.167	155.8	0.016	74.8	0.920	-19.3
400	0.619	-61.1	19.169	136.8	0.028	63.5	0.805	-34.0
600	0.525	-80.6	15.607	122.5	0.035	57.8	0.689	-41.6
800	0.478	-97.2	13.078	112.1	0.041	55.3	0.596	-47.6
1000	0.450	-110.6	11.090	103.7	0.046	53.8	0.534	-51.3
1200	0.414	-122.4	9.645	97.3	0.050	53.6	0.491	-53.9
1400	0.396	-131.1	8.445	91.8	0.055	53.6	0.459	-56.6
1600	0.383	-140.1	7.498	86.7	0.060	54.1	0.427	-58.4
1800	0.370	-147.9	6.766	82.4	0.065	54.3	0.404	-59.7
2000	0.362	-154.6	6.073	78.4	0.070	53.8	0.396	-60.7
2200	0.354	-161.1	5.620	74.6	0.075	53.9	0.371	-62.3
2400	0.349	-167.2	5.196	71.0	0.081	53.3	0.357	-63.3
2600	0.347	-172.3	4.812	67.4	0.085	53.2	0.344	-63.7
2800	0.345	-177.9	4.466	64.3	0.091	52.0	0.333	-64.8
3000	0.345	175.5	4.240	61.0	0.096	51.5	0.313	-67.0
3200	0.349	170.4	3.992	57.9	0.101	50.3	0.299	-68.4
3400	0.352	165.4	3.774	54.9	0.107	49.8	0.288	-69.6
3600	0.358	160.3	3.582	51.9	0.112	48.7	0.274	-71.2
3800	0.365	156.2	3.414	48.9	0.118	47.9	0.261	-73.2
4000	0.374	152.3	3.257	46.0	0.122	46.4	0.249	-75.3
4200	0.383	147.8	3.116	43.2	0.128	45.1	0.235	-77.7
4400	0.393	143.8	2.987	40.2	0.133	43.7	0.221	-80.3
4600	0.403	140.0	2.869	37.5	0.138	42.4	0.211	-83.0
4800	0.411	136.6	2.757	34.7	0.142	41.0	0.200	-85.5
5000	0.418	133.1	2.664	32.0	0.148	39.6	0.192	-88.7
5200	0.425	130.3	2.559	29.3	0.152	38.3	0.187	-91.9
5400	0.431	127.0	2.484	26.6	0.157	36.8	0.179	-94.9
5600	0.438	124.1	2.389	24.1	0.162	35.4	0.183	-98.2
5800	0.441	121.3	2.327	21.2	0.166	33.8	0.174	-101.5
6000	0.443	117.4	2.268	18.5	0.171	32.1	0.170	-105.1

SBPF420M

S パラメータ (エミッタ接地)

V_{CE}=2V, I_C=20mA, Z_O=50Ω

Freq(MHz)	S ₁₁	∠S ₁₁	S ₂₁	∠S ₂₁	S ₁₂	∠S ₁₂	S ₂₂	∠S ₂₂
200	0.500	-48.7	32.142	148.5	0.014	71.8	0.864	-24.9
400	0.453	-84.1	25.049	126.9	0.023	63.2	0.698	-40.4
600	0.383	-105.7	19.103	113.3	0.028	60.8	0.573	-46.2
800	0.360	-121.7	15.261	103.9	0.033	61.3	0.485	-50.6
1000	0.349	-134.1	12.647	96.7	0.039	61.7	0.434	-53.3
1200	0.336	-144.3	10.741	91.0	0.044	62.0	0.402	-54.2
1400	0.327	-151.6	9.317	86.3	0.050	62.0	0.378	-56.5
1600	0.324	-158.8	8.205	81.8	0.056	63.1	0.355	-57.5
1800	0.319	-165.4	7.339	77.9	0.062	62.8	0.339	-58.4
2000	0.316	-171.3	6.616	74.5	0.068	61.8	0.330	-59.6
2200	0.311	-176.7	6.061	71.0	0.074	61.4	0.316	-60.5
2400	0.311	178.2	5.575	67.7	0.080	60.8	0.304	-61.3
2600	0.311	173.6	5.176	64.5	0.086	59.7	0.294	-62.0
2800	0.312	168.9	4.818	61.7	0.091	58.2	0.282	-62.8
3000	0.317	163.7	4.515	58.6	0.098	57.6	0.270	-64.7
3200	0.323	159.4	4.244	55.7	0.104	56.1	0.257	-66.0
3400	0.328	155.1	4.012	52.9	0.109	55.1	0.248	-67.3
3600	0.336	150.9	3.802	50.2	0.116	53.7	0.235	-68.9
3800	0.344	147.4	3.620	47.4	0.121	51.8	0.221	-70.5
4000	0.354	144.2	3.454	44.6	0.127	50.5	0.211	-72.8
4200	0.365	140.4	3.301	41.9	0.132	49.0	0.198	-75.3
4400	0.376	137.1	3.159	39.1	0.138	47.3	0.186	-78.2
4600	0.385	133.7	3.031	36.5	0.143	45.7	0.175	-81.1
4800	0.394	130.8	2.917	33.9	0.148	44.0	0.165	-83.8
5000	0.403	127.8	2.815	31.3	0.154	42.5	0.157	-87.0
5200	0.410	125.0	2.716	28.7	0.158	40.6	0.151	-90.5
5400	0.417	122.2	2.620	26.1	0.163	39.3	0.145	-94.3
5600	0.422	119.7	2.541	23.7	0.169	37.6	0.144	-97.4
5800	0.426	116.8	2.461	20.9	0.173	35.7	0.139	-101.1
6000	0.429	113.4	2.398	18.2	0.179	33.7	0.136	-105.0

SBPF420M

S パラメータ (エミッタ接地)

$V_{CE}=3V, I_C=5mA, Z_O=50\Omega$

Freq(MHz)	$ S_{11} $	$\angle S_{11}$	$ S_{21} $	$\angle S_{21}$	$ S_{12} $	$\angle S_{12}$	$ S_{22} $	$\angle S_{22}$
200	0.869	-17.5	9.393	162.2	0.016	78.0	0.926	-13.0
400	0.837	-35.2	9.129	148.5	0.030	67.6	0.904	-23.6
600	0.761	-49.5	8.139	136.2	0.039	59.5	0.818	-30.0
800	0.682	-65.6	8.125	125.4	0.046	54.9	0.754	-37.2
1000	0.644	-77.2	7.386	116.7	0.053	49.6	0.689	-41.6
1200	0.576	-92.7	7.051	108.3	0.055	48.2	0.646	-45.9
1400	0.534	-103.9	6.475	101.6	0.060	46.9	0.610	-48.2
1600	0.494	-114.1	5.974	95.1	0.064	46.2	0.569	-50.4
1800	0.465	-123.3	5.491	90.1	0.067	45.9	0.549	-53.2
2000	0.445	-130.7	4.885	85.6	0.071	46.4	0.539	-53.6
2200	0.434	-138.9	4.718	80.8	0.074	44.7	0.506	-55.9
2400	0.422	-146.4	4.424	76.3	0.078	45.1	0.488	-57.7
2600	0.411	-153.2	4.093	71.7	0.082	44.7	0.473	-58.1
2800	0.403	-159.1	3.777	68.4	0.086	44.0	0.469	-59.4
3000	0.399	-166.3	3.692	64.9	0.090	44.0	0.441	-61.8
3200	0.399	-172.8	3.503	61.2	0.093	43.9	0.422	-63.2
3400	0.390	-179.0	3.315	57.7	0.098	43.1	0.407	-64.5
3600	0.391	175.9	3.162	54.3	0.102	42.8	0.393	-66.8
3800	0.396	171.2	3.025	51.0	0.105	42.0	0.379	-68.8
4000	0.401	165.6	2.886	47.7	0.109	41.7	0.362	-70.4
4200	0.403	160.7	2.774	44.4	0.115	40.5	0.348	-72.5
4400	0.400	155.9	2.674	41.3	0.118	39.6	0.334	-75.6
4600	0.408	152.2	2.571	38.2	0.123	39.1	0.323	-77.8
4800	0.416	147.8	2.481	35.3	0.127	37.7	0.311	-79.8
5000	0.419	143.0	2.398	32.3	0.132	36.8	0.301	-83.0
5200	0.422	139.0	2.287	29.1	0.135	35.5	0.303	-86.0
5400	0.417	135.4	2.238	26.0	0.139	34.0	0.290	-88.6
5600	0.426	132.4	2.109	23.6	0.144	33.2	0.302	-92.0
5800	0.428	128.5	2.098	20.6	0.148	32.4	0.282	-95.1
6000	0.428	124.1	2.042	17.7	0.153	31.1	0.278	-97.2

SBPF420M

S パラメータ (エミッタ接地)

$V_{CE}=3V, I_C=10mA, Z_0=50\Omega$

Freq(MHz)	$ S_{11} $	$\angle S_{11}$	$ S_{21} $	$\angle S_{21}$	$ S_{12} $	$\angle S_{12}$	$ S_{22} $	$\angle S_{22}$
200	0.682	-30.9	21.781	156.2	0.015	72.8	0.926	-17.3
400	0.626	-57.9	19.135	137.7	0.025	62.7	0.824	-30.5
600	0.514	-74.4	15.629	122.9	0.033	58.0	0.707	-40.0
800	0.468	-89.4	13.148	113.2	0.039	57.1	0.646	-42.4
1000	0.419	-107.7	11.139	104.2	0.042	57.0	0.573	-43.4
1200	0.394	-118.2	9.778	97.1	0.044	56.2	0.526	-50.2
1400	0.370	-128.7	8.475	91.6	0.050	55.7	0.490	-50.9
1600	0.358	-136.9	7.601	87.0	0.056	56.9	0.480	-52.6
1800	0.341	-144.7	6.816	82.9	0.059	57.1	0.446	-52.5
2000	0.327	-152.5	6.063	78.5	0.065	55.1	0.434	-53.8
2200	0.322	-158.9	5.678	74.5	0.070	55.7	0.415	-56.2
2400	0.322	-164.1	5.254	71.0	0.077	55.9	0.409	-57.0
2600	0.320	-169.4	4.877	67.3	0.081	53.7	0.391	-57.5
2800	0.324	-176.4	4.503	64.0	0.086	53.9	0.381	-58.3
3000	0.328	177.8	4.291	60.6	0.091	52.7	0.365	-60.6
3200	0.324	172.7	4.038	57.6	0.095	52.3	0.352	-61.5
3400	0.329	167.9	3.806	54.7	0.102	50.9	0.339	-62.2
3600	0.331	162.8	3.616	51.6	0.106	50.0	0.321	-64.8
3800	0.333	159.0	3.455	48.6	0.111	50.1	0.306	-67.1
4000	0.339	155.4	3.294	45.8	0.118	47.9	0.298	-70.3
4200	0.357	151.6	3.164	43.1	0.122	46.3	0.281	-70.9
4400	0.354	147.0	3.028	40.2	0.128	44.7	0.265	-73.3
4600	0.360	143.8	2.905	37.2	0.131	45.2	0.256	-76.5
4800	0.367	140.5	2.812	34.3	0.139	42.5	0.249	-78.7
5000	0.373	136.4	2.717	31.5	0.142	40.7	0.240	-80.1
5200	0.381	132.5	2.618	28.7	0.148	39.1	0.232	-83.3
5400	0.378	129.2	2.531	26.0	0.152	37.9	0.224	-87.6
5600	0.384	126.2	2.431	23.5	0.156	36.7	0.231	-91.5
5800	0.384	122.6	2.374	20.6	0.163	35.1	0.221	-93.6
6000	0.391	119.1	2.311	17.8	0.165	32.4	0.215	-95.0

SBPF420M

S パラメータ (エミッタ接地)

V_{CE}=5V, I_C=20mA, Z_O=50Ω

Freq(MHz)	S ₁₁	∠S ₁₁	S ₂₁	∠S ₂₁	S ₁₂	∠S ₁₂	S ₂₂	∠S ₂₂
200	0.505	-45.1	31.962	149.1	0.012	75.3	0.877	-22.3
400	0.450	-79.1	25.264	128.0	0.020	62.3	0.723	-35.9
600	0.354	-98.7	19.263	113.4	0.026	59.3	0.602	-43.6
800	0.327	-112.3	15.424	104.8	0.031	62.1	0.548	-44.1
1000	0.313	-131.6	12.751	97.1	0.036	63.4	0.482	-43.2
1200	0.304	-139.4	10.908	91.0	0.040	61.6	0.447	-50.0
1400	0.294	-149.2	9.450	85.9	0.046	63.8	0.417	-49.4
1600	0.291	-155.9	8.351	81.6	0.053	63.9	0.416	-50.8
1800	0.283	-162.5	7.447	78.1	0.058	63.9	0.390	-50.2
2000	0.277	-169.2	6.625	74.6	0.064	63.6	0.378	-51.3
2200	0.276	-174.6	6.131	71.4	0.069	63.4	0.365	-53.4
2400	0.278	-179.1	5.656	67.7	0.077	62.1	0.366	-54.4
2600	0.275	177.2	5.252	64.5	0.082	61.7	0.347	-55.1
2800	0.288	170.6	4.853	61.4	0.086	61.0	0.336	-56.1
3000	0.293	165.9	4.585	58.2	0.092	58.1	0.329	-59.1
3200	0.295	161.3	4.305	55.4	0.098	57.6	0.316	-58.6
3400	0.297	157.6	4.055	52.6	0.104	55.7	0.306	-59.5
3600	0.307	153.3	3.859	49.8	0.109	55.1	0.287	-62.0
3800	0.307	149.7	3.679	47.0	0.115	54.0	0.272	-64.3
4000	0.312	147.5	3.489	44.3	0.119	52.0	0.265	-67.7
4200	0.331	143.6	3.354	41.8	0.126	50.5	0.250	-68.1
4400	0.332	140.1	3.208	39.0	0.131	48.1	0.236	-70.8
4600	0.341	137.1	3.087	36.3	0.136	48.0	0.224	-73.9
4800	0.345	133.7	2.984	33.6	0.143	44.8	0.220	-76.2
5000	0.356	130.7	2.881	30.8	0.147	43.8	0.210	-77.9
5200	0.363	127.1	2.788	28.1	0.155	41.8	0.202	-80.4
5400	0.361	123.6	2.678	25.6	0.158	40.0	0.192	-85.8
5600	0.364	121.1	2.594	23.1	0.162	37.8	0.194	-88.6
5800	0.366	118.2	2.523	20.2	0.170	37.0	0.190	-91.3
6000	0.372	114.3	2.445	17.6	0.174	34.8	0.184	-93.0

SBPF420M

SPICE パラメータ

model : Gummel-Poon

Parameter	Value	Unit	Parameter	Value	Unit
IS	0.20045f	A	TF	6.7661p	S
BF	72.534		XTF	0.42199	
NF	1.2432		VTF	0.23794	V
VAF	28.383	V	ITF	1m	A
IKF	0.48731	A	PTF	0	deg
ISE	19.049f	A	CJC	234.53f	F
NE	2.0518		VJC	0.81969	V
BR	7.8287		MJC	0.30232	
NR	1.3325		XCJC	0.3	
VAR	19.705	V	TR	2.3249n	S
IKR	691.41m	A	FC	0.73234	
ISC	19.237a	A	CJS	0	F
NC	1.1724		VJS	0.75	V
RB	8.5757	Ω	MJS	0	
IRB	729.83μ	A	CC	20f	F
RBM	3.4849	Ω	Cbc	20f	F
RE	0.31111	Ω	Cbe	20f	F
RC	0.10105	Ω	Lb	0.80n	H
XTB	0		Lc	0.84n	H
EG	1.11	eV	Le	1.0n	H
XTI	3				
CJE	1.8063f	F			
VJE	0.8051	V			
MJE	0.46576				

回路図

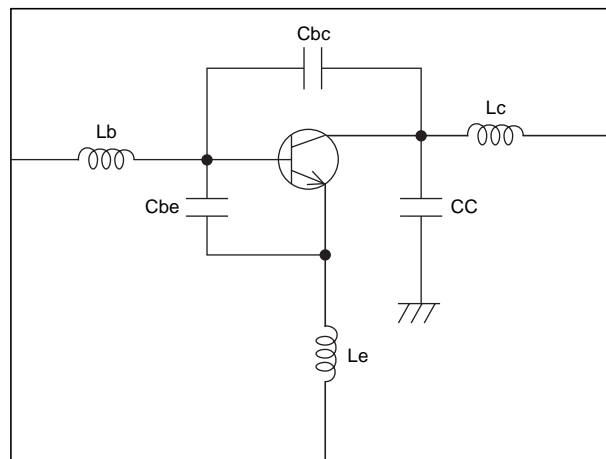

* 本資料に掲載している SPICE パラメータ・データは当社の任意条件のもとに抽出した参考データです。このため保証するものではありません。本パラメータは開発・設計等の目安としてご利用ください。

- 本書記載の製品は、定められた条件下において、記載部品単体の性能・特性・機能などを規定するものであり、お客様の製品（機器）での性能・特性・機能などを保証するものではありません。部品単体の評価では予測できない症状・事態を確認するためにも、お客様の製品で必要とされる評価・試験を必ず行って下さい。
- 弊社は、高品質・高信頼性の製品を供給することに努めております。しかし、半導体製品はある確率で故障が生じてしまいます。この故障が原因となり、人命にかかわる事故、発煙・発火事故、他の物品に損害を与えてしまう事故などを引き起こす可能性があります。機器設計時には、このような事故を起こさないような、保護回路・誤動作防止回路等の安全設計、冗長設計・機構設計等の安全対策を行って下さい。
- 本書記載の製品が、外国為替及び外国貿易法に定める規制貨物（役務を含む）に該当する場合、輸出する際に同法に基づく輸出許可が必要です。
- 弊社の承諾なしに、本書の一部または全部を、転載または複製することを禁止します。
- 本書に記載された内容は、製品改善および技術改良等により将来予告なしに変更することがあります。したがって、ご使用の際には、「納入仕様書」でご確認下さい。
- この資料の情報（掲載回路および回路定数を含む）は一例を示すもので、量産セットとしての設計を保証するものではありません。また、この資料は正確かつ信頼すべきものであると確信しておりますが、その使用にあたって第三者の工業所有権その他の権利の実施に対する保証を行うものではありません。