

**Amplifier, Power, 0.5W
12.7-15.4 GHz**

MAAP-000044-PKG003
Rev A
Preliminary Datasheet

Features

- ◆ 0.5 Watt Saturated Output Power Level
- ◆ Variable Drain Voltage (6-10V) Operation
- ◆ MSAG™ Process
- ◆ 5x5 mm 20 Lead MLP Package

Description

The MAAP-000044-PKG0003 is a 3-stage 0.5 W power amplifier with on-chip bias networks in a 20 lead MLP package, allowing easy assembly. This product is fully matched to 50 ohms on both the input and output. It can be used as a power amplifier stage or as a driver stage in high power applications.

Each device is 100% RF tested to ensure performance compliance. The part is fabricated using M/A-COM's GaAs Multifunction Self-Aligned Gate (MSAG™) Process.

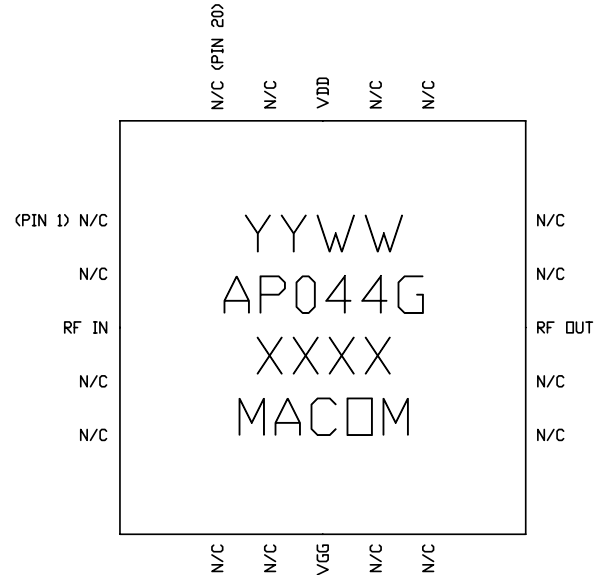

Primary Applications

- ◆ **Point-to-Point Radio**
 - ◇ 13 and 15 GHz Bands
- ◆ **SatCom**
- ◆ **Radio Communications**

Also Available in:

		SAMPLE BOARD
Description	Die	Plastic Package
Part Number	MAAPGM0044-DIE	MAAP-000044-SMB003

Electrical Characteristics: $T_C = 30^\circ C^1$, $Z_0 = 50\Omega$, $V_{DD} = 8V$, $I_{DQ} = 210 mA^2$, $P_{in} = 14dBm$, $R_G = 350\Omega$

Parameter	Symbol	Typical	Units
Bandwidth	f	12.7-15.4	GHz
Output Power	P_{OUT}	27	dBm
Power Added Efficiency	PAE	22	%
1-dB Compression Point	P_{1dB}	26	dBm
Small Signal Gain	G	17	dB
Input VSWR	VSWR	2.5:1	—
Output VSWR	VSWR	2.2:1	—
Gate Supply Current	I_{GG}	< 2	mA
Drain Supply Current	I_{DD}	< 0.4	A
Output Third Order Intercept	OTOI	34	dBm
3 rd Order Intermodulation Distortion, Single Carrier Level = 16 dBm	IM3	-20	dBm

1. T_C = Case Temperature.
2. Adjust V_{GG} between -2.6 to -1.2 to achieve indicated I_{DQ} .

M/A-COM Inc. and its affiliates reserve the right to make changes to the product(s) or information contained herein without notice. M/A-COM makes no warranty, representation or guarantee regarding the suitability of its products for any particular purpose, nor does M/A-COM assume any liability whatsoever arising out of the use or application of any product(s) or information.

- **North America** Tel: 800.366.2266 / Fax: 978.366.2266
- **Europe** Tel: 44.1908.574.200 / Fax: 44.1908.574.300
- **Asia/Pacific** Tel: 81.44.844.8296 / Fax: 81.44.844.8298

Visit www.macom.com for additional data sheets and product information.

**Amplifier, Power, 0.5W
12.7-15.4 GHz**

MAAP-000044-PKG003
Rev A
Preliminary Datasheet

Maximum Ratings³

Parameter	Symbol	Absolute Maximum	Units
Input Power	P_{IN}	19.0	dBm
Drain Supply Voltage	V_{DD}	+12.0	V
Gate Supply Voltage	V_{GG}	-3.0	V
Quiescent Drain Current (No RF)	I_{DQ}	340	mA
Quiescent DC Power Dissipated (No RF)	P_{DISS}	3.4	W
Junction Temperature	T_J	170	°C
Storage Temperature	T_{STG}	-55 to +150	°C

3. Operation beyond these limits may result in permanent damage to the part.

Recommended Operating Conditions⁴

Characteristic	Symbol	Min	Typ	Max	Unit
Drain Supply Voltage	V_{DD}	6.0	8.0	10.0	V
Gate Supply Voltage	V_{GG}	-2.6	-1.7	-1.2	V
Input Power	P_{IN}		14.0	17.0	dBm
Junction Temperature	T_J			150	°C
Thermal Resistance	Θ_{JC}		33.4		°C/W
Package Base Temperature	T_B			Note 5	°C

4. Operation outside of these ranges may reduce product reliability.

5. Maximum Package Case Temperature = 170°C — $\Theta_{JC} * V_{DD} * I_{DQ}$

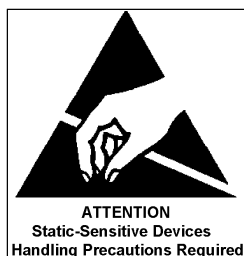

Operating Instructions

This device is static sensitive. Please handle with care. To operate the device, follow these steps.

1. Apply $V_{GG} = -1.7$ V, $V_{DD} = 0$ V.
2. Ramp V_{DD} to desired voltage, typically 8 V.
3. Adjust V_{GG} to set I_{DQ} , (approximately @ -1.7V).
4. Set RF input.
5. Power down sequence in reverse. Turn gate voltage off last.

Power Derating Curve, Quiescent (No RF)

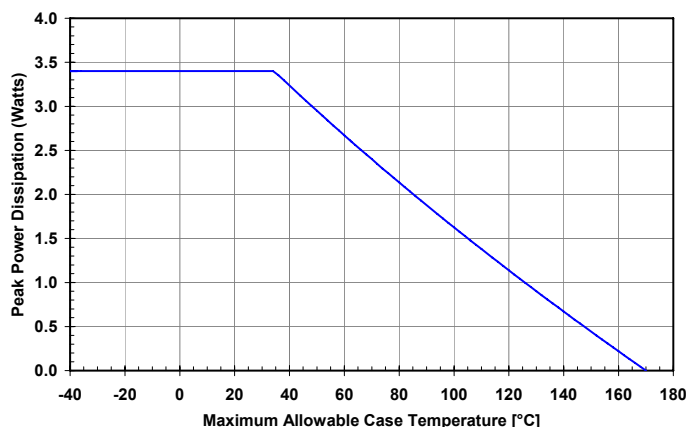

**Amplifier, Power, 0.5W
12.7-15.4 GHz**

MAAP-000044-PKG003
Rev A
Preliminary Datasheet

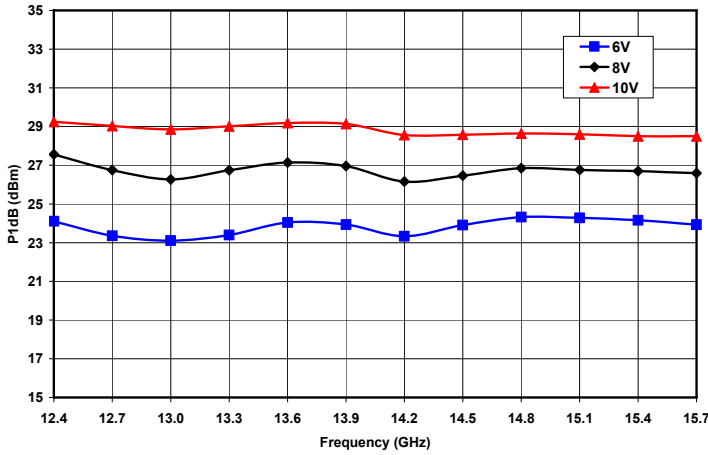

Figure 1. 1 dB Compression Point vs. Frequency and Drain Voltage at IDQ = 210mA

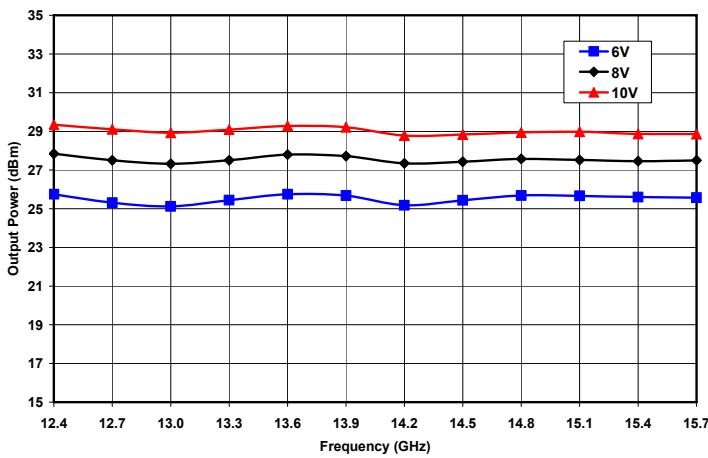

Figure 3. Saturated Output Power vs. Frequency and Drain Voltage at IDQ = 210mA

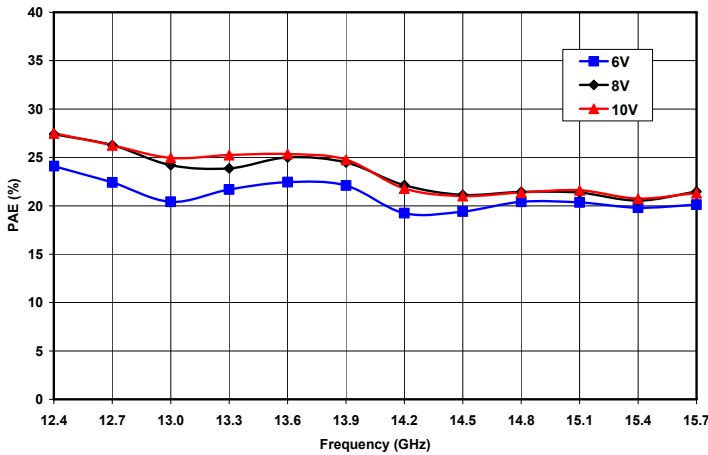

Figure 5. Saturated Power Added Efficiency vs. Frequency and Drain Voltage at IDQ = 210mA

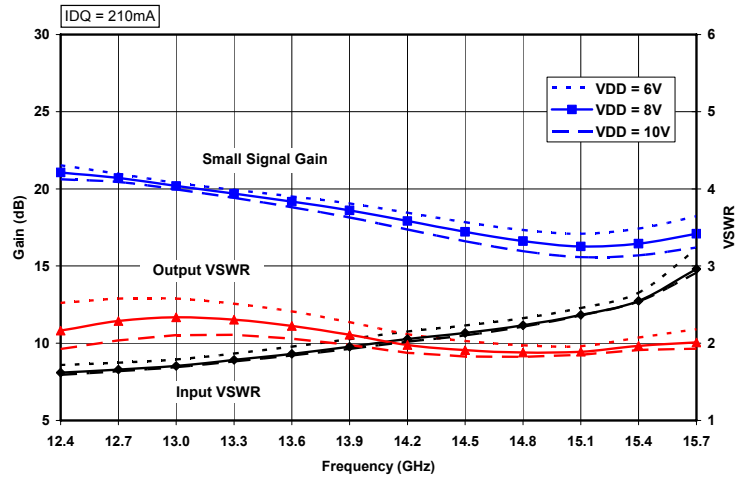

Figure 2. Small Signal Gain and Input & Output VSWR vs. Frequency and Drain Voltage at IDQ = 210mA

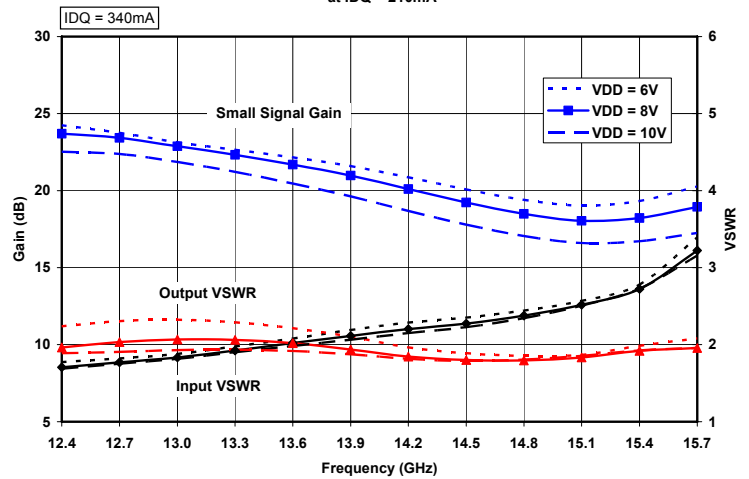

Figure 4. Small Signal Gain and Input & Output VSWR vs. Frequency and Drain Voltage at IDQ = 340mA

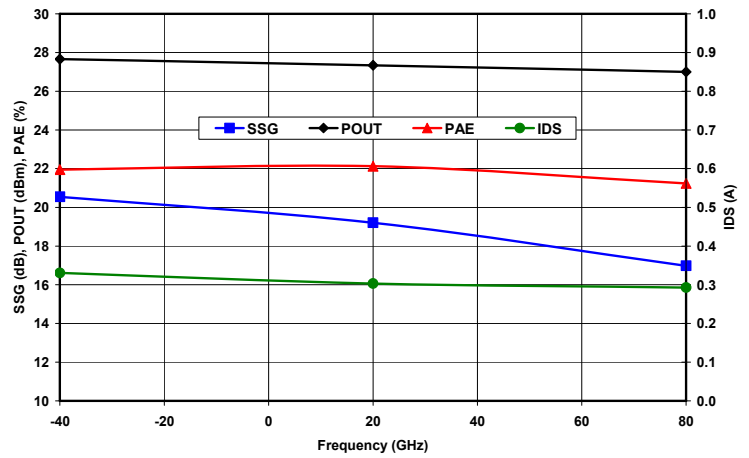

Figure 6. Small Signal Gain & Saturated Output Power, Power Added Efficiency and Drain Current vs. Case Temperature at 14.2 GHz, VD = 8V and IDQ = 210mA

**Amplifier, Power, 0.5W
12.7-15.4 GHz**

MAAP-000044-PKG003
Rev A
Preliminary Datasheet

VD = 6V

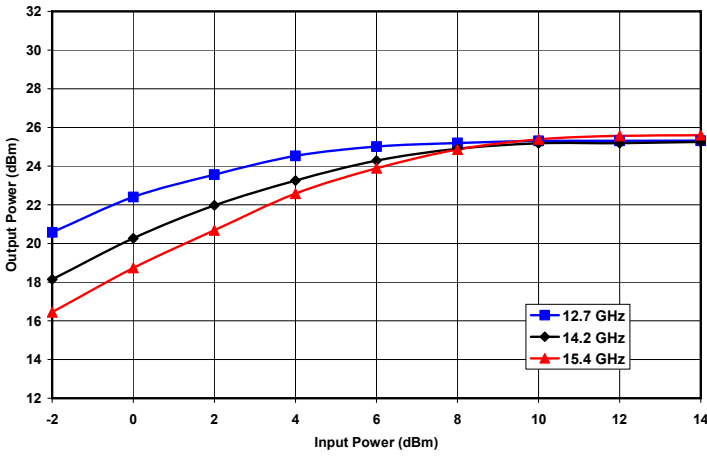

Figure 7. Output Power vs. Input Power and Frequency at VD = 6V and IDQ = 210mA

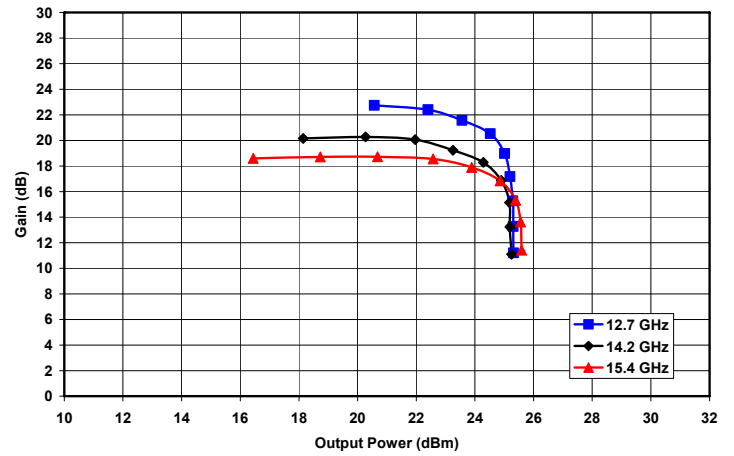

Figure 8. Gain vs. Output Power and Frequency at VD = 6V and IDQ = 210mA

VD = 8V

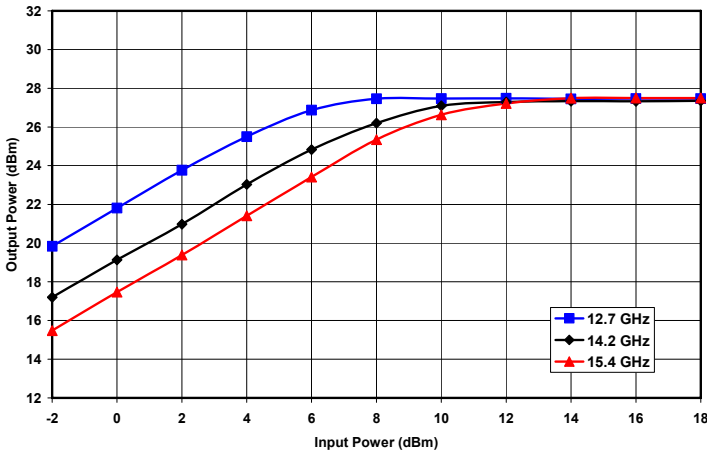

Figure 9. Output Power vs. Input Power and Frequency at VD = 8V and IDQ = 210mA

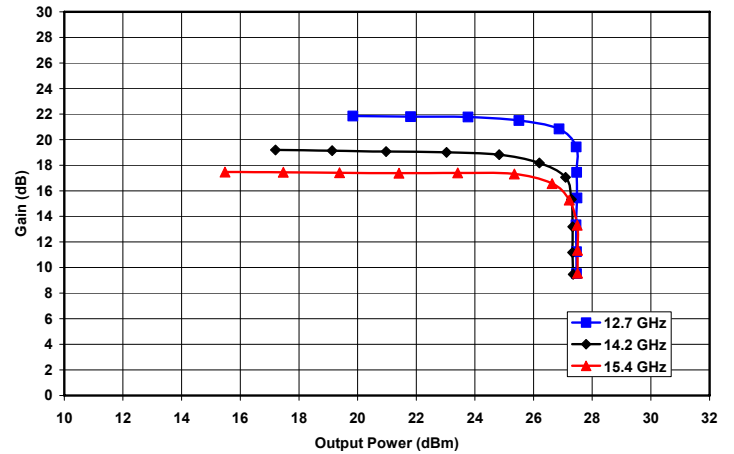

Figure 10. Gain vs. Output Power and Frequency at VD = 8V and IDQ = 210mA

VD = 10V

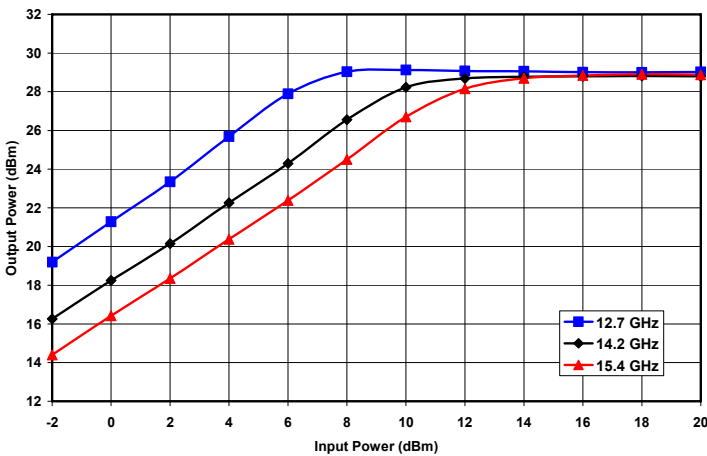

Figure 11. Output Power vs. Input Power and Frequency at VD = 10V and IDQ = 210mA

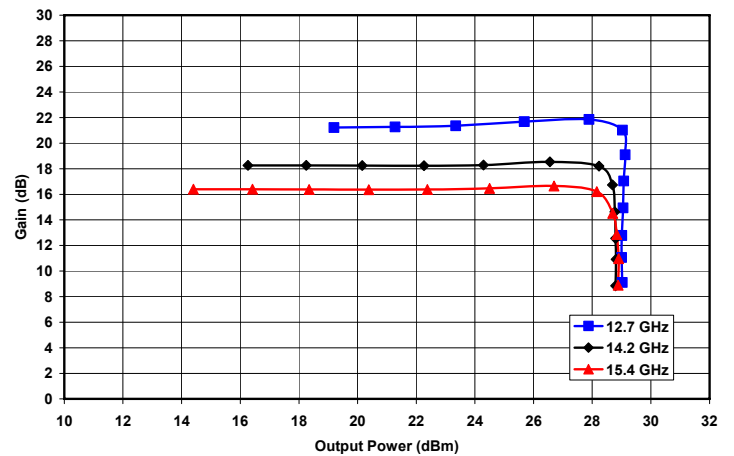

Figure 12. Gain vs. Output Power and Frequency at VD = 10V and IDQ = 210mA

**Amplifier, Power, 0.5W
12.7-15.4 GHz**

MAAP-000044-PKG003
Rev A
Preliminary Datasheet

VD = 6V

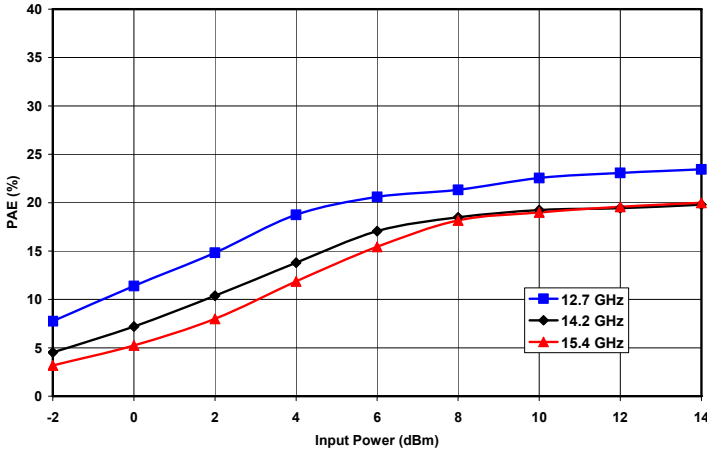

Figure 13. Power Added Efficiency vs. Input Power and Frequency at VD = 6V and IDQ = 210mA

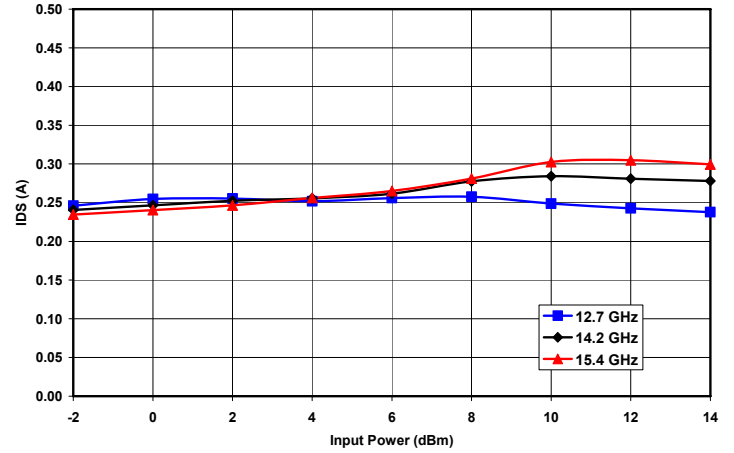

Figure 14. Drain Current vs. Input Power and Frequency at VD = 6V and IDQ = 210mA

VD = 8V

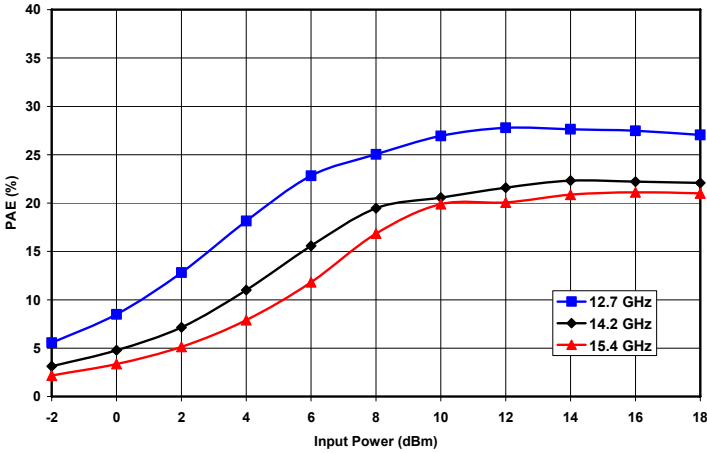

Figure 15. Power Added Efficiency vs. Input Power and Frequency at VD = 8V and IDQ = 210mA

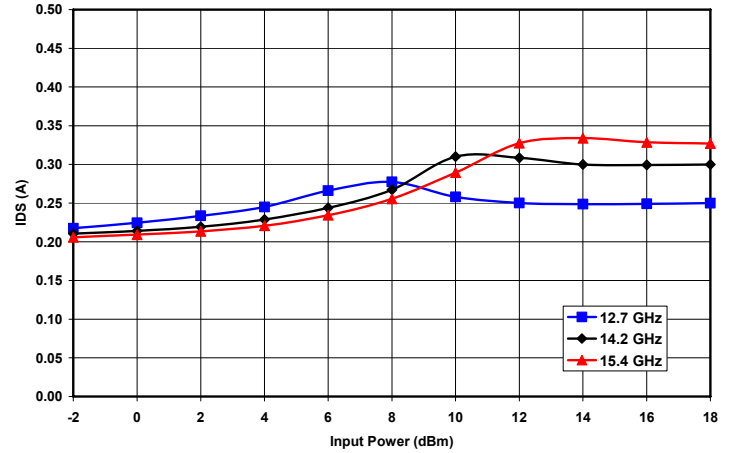

Figure 16. Drain Current vs. Input Power and Frequency at VD = 8V and IDQ = 210mA

VD = 10V

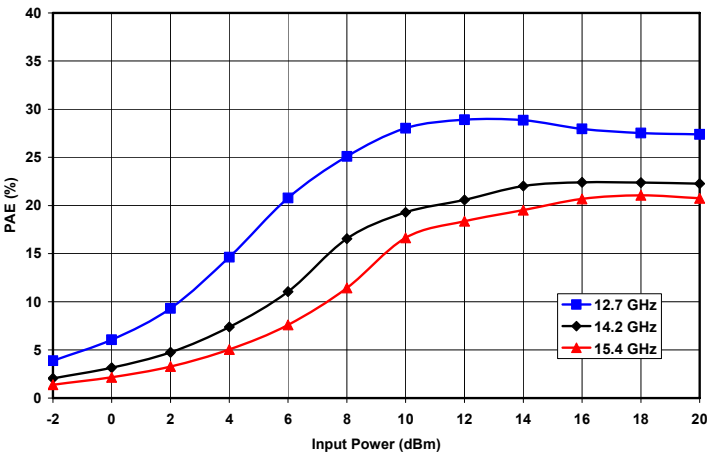

Figure 17. Power Added Efficiency vs. Input Power and Frequency at VD = 10V and IDQ = 210mA

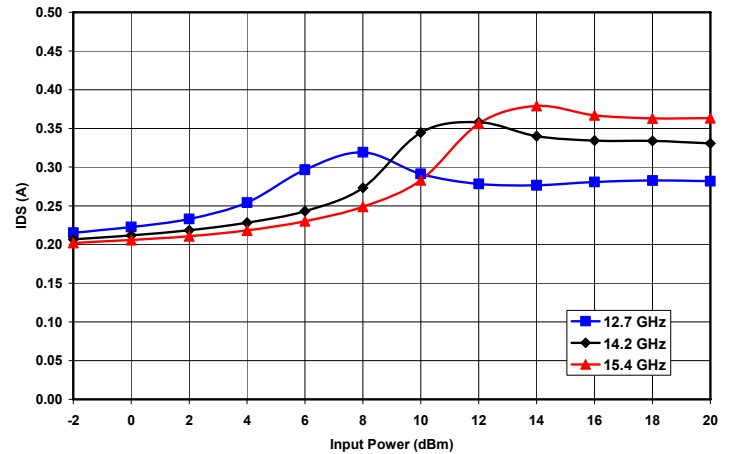

Figure 18. Drain Current vs. Input Power and Frequency at VD = 10V and IDQ = 210mA

**Amplifier, Power, 0.5W
12.7-15.4 GHz**

MAAP-000044-PKG003
Rev A
Preliminary Datasheet

VD = 6V

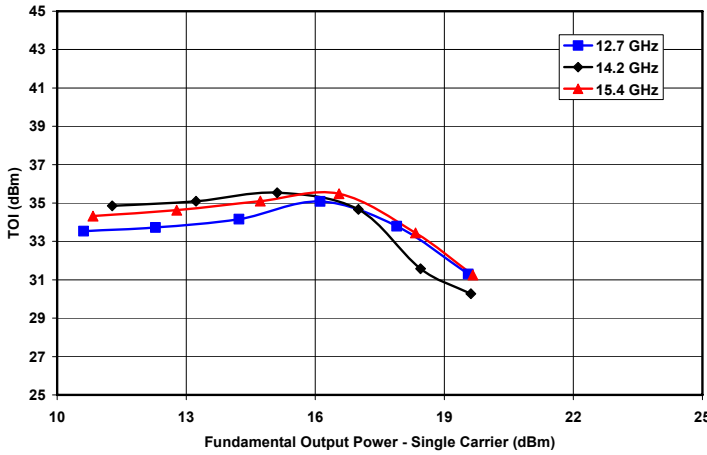

Figure 19. Third Order Intercept vs. Output Power and Frequency at VD = 6V and IDQ =210mA

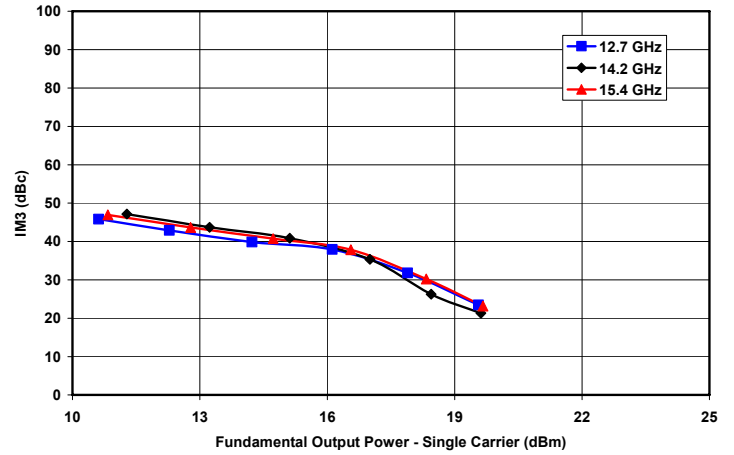

Figure 20. Third Order Intermod vs. Output Power and Frequency at VD = 6V and IDQ =210mA

VD = 8V

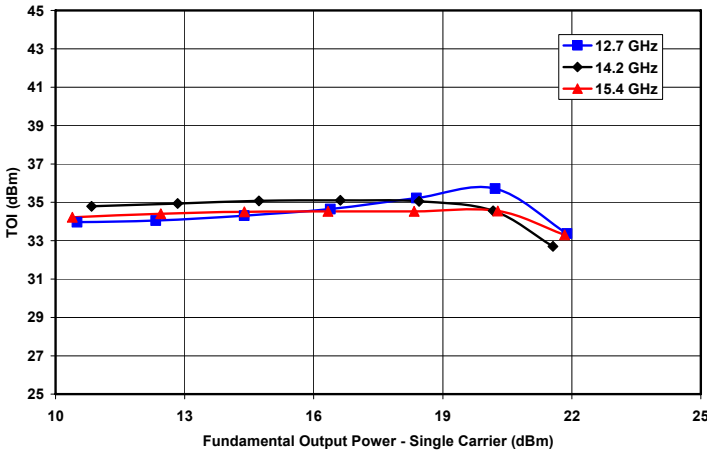

Figure 21. Third Order Intercept vs. Output Power and Frequency at VD = 8V and IDQ =210mA

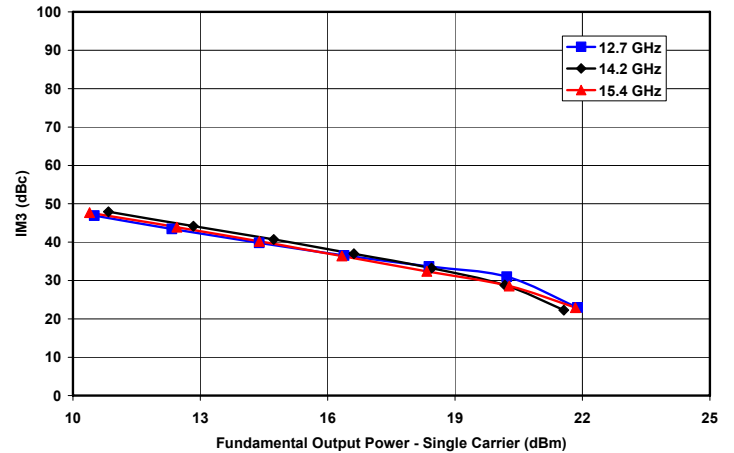

Figure 22. Third Order Intermod vs. Output Power and Frequency at VD = 8V and IDQ =210mA

VD = 10V

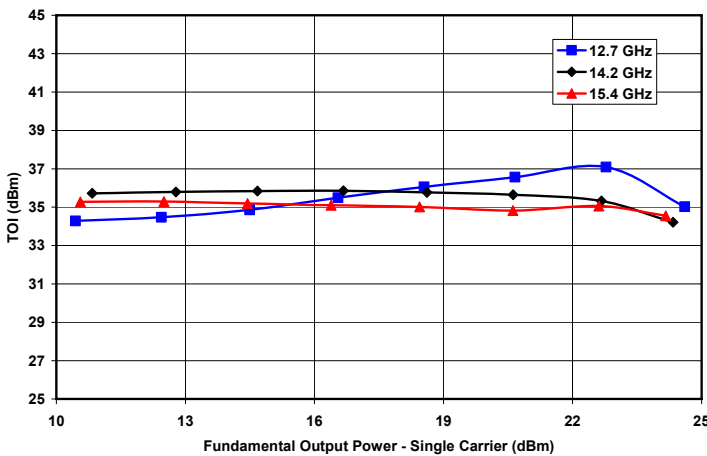

Figure 23. Third Order Intercept vs. Output Power and Frequency at VD = 10V and IDQ =210mA

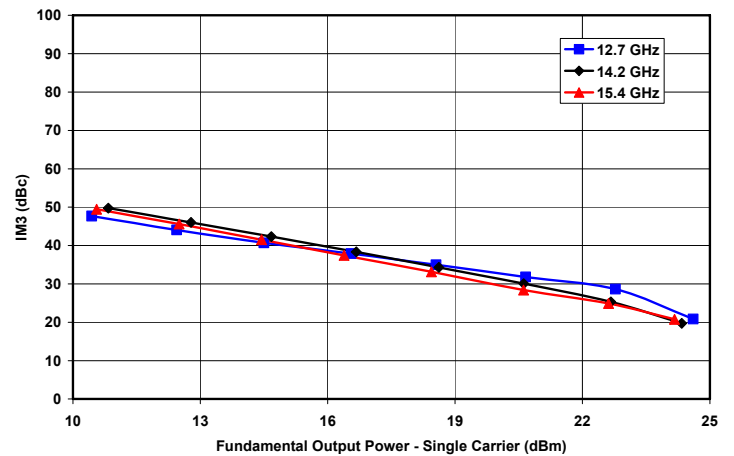

Figure 24. Third Order Intermod vs. Output Power and Frequency at VD = 10V and IDQ =210mA

**Amplifier, Power, 0.5W
12.7-15.4 GHz**

MAAP-000044-PKG003
Rev A
Preliminary Datasheet

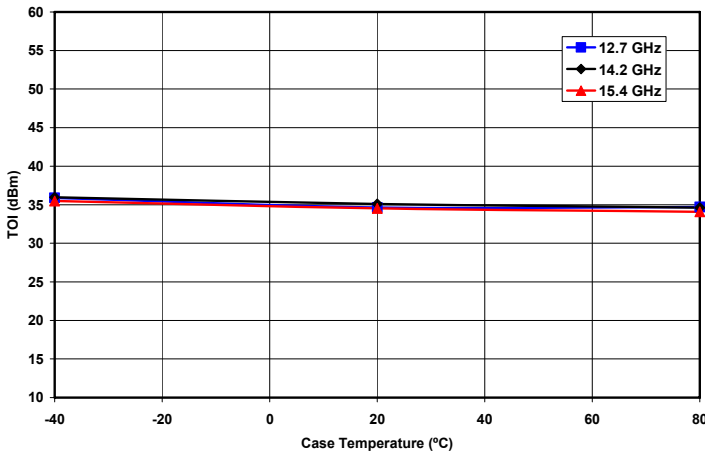

Figure 25. Third Order Intercept vs. Case Temperature and Frequency at Single Carrier Output Power Level = 16 dBm, VD = 8V and IDQ = 210mA

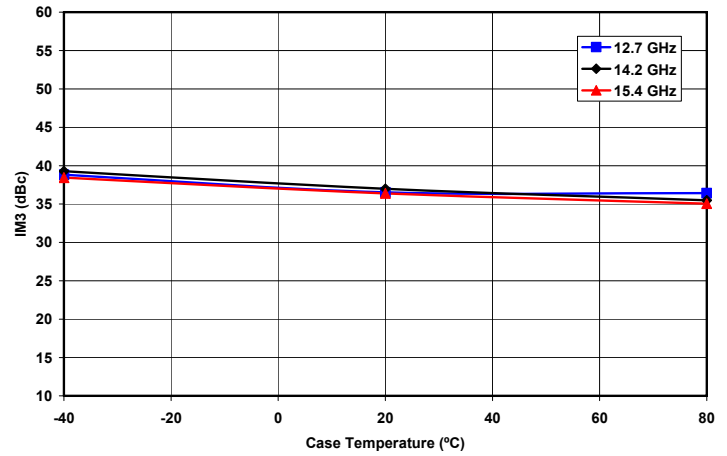

Figure 26. Third Order Intermod vs. Case Temperature and Frequency at Single Carrier Output Power Level = 16 dBm, VD = 8V and IDQ = 210mA

**Amplifier, Power, 0.5W
12.7-15.4 GHz**

MAAP-000044-PKG003
Rev A
Preliminary Datasheet

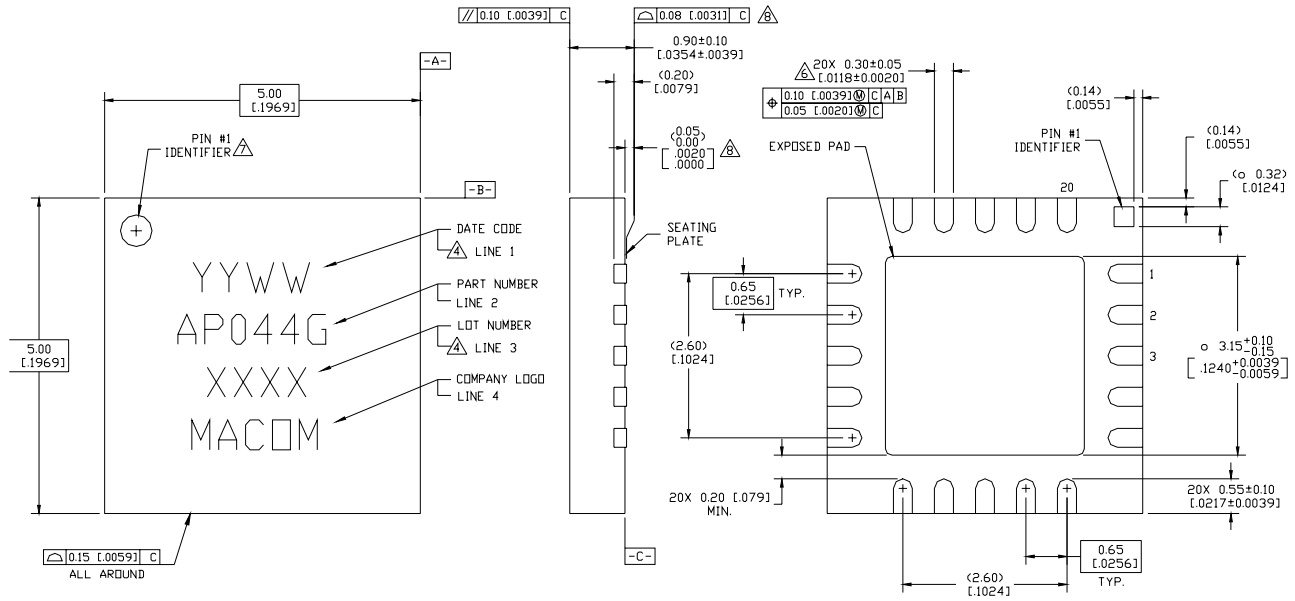

Figure 27. 5x5 mm 20-Lead MLP.

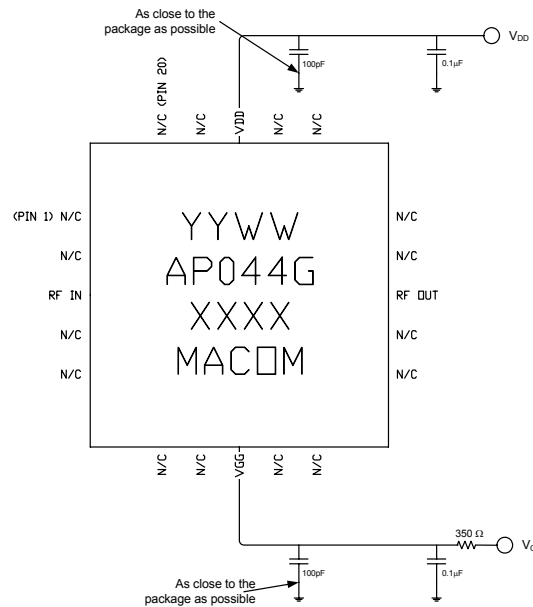

Figure 28. Recommended Bias Configuration.

Note: The exposed pad centered on the package bottom must be connected to RF and dc ground for proper electrical and thermal operation.

Refer to M/A-COM Application Note **Surface Mounting Instructions for PQFN Packages #S2083*** for assembly guidelines.

Additional Precaution: All parts must receive a bake-out of 125°C for 24 hours prior to any solder reflow operation.

*Application Notes can be found by going to the Site Search Page of M/A-COM's web page (<http://www.macom.com/search/search.jsp>) and searching for the required Application Note.

Amplifier, Power, 0.5W
12.7-15.4 GHz

MAAP-000044-PKG003
Rev A
Preliminary Datasheet

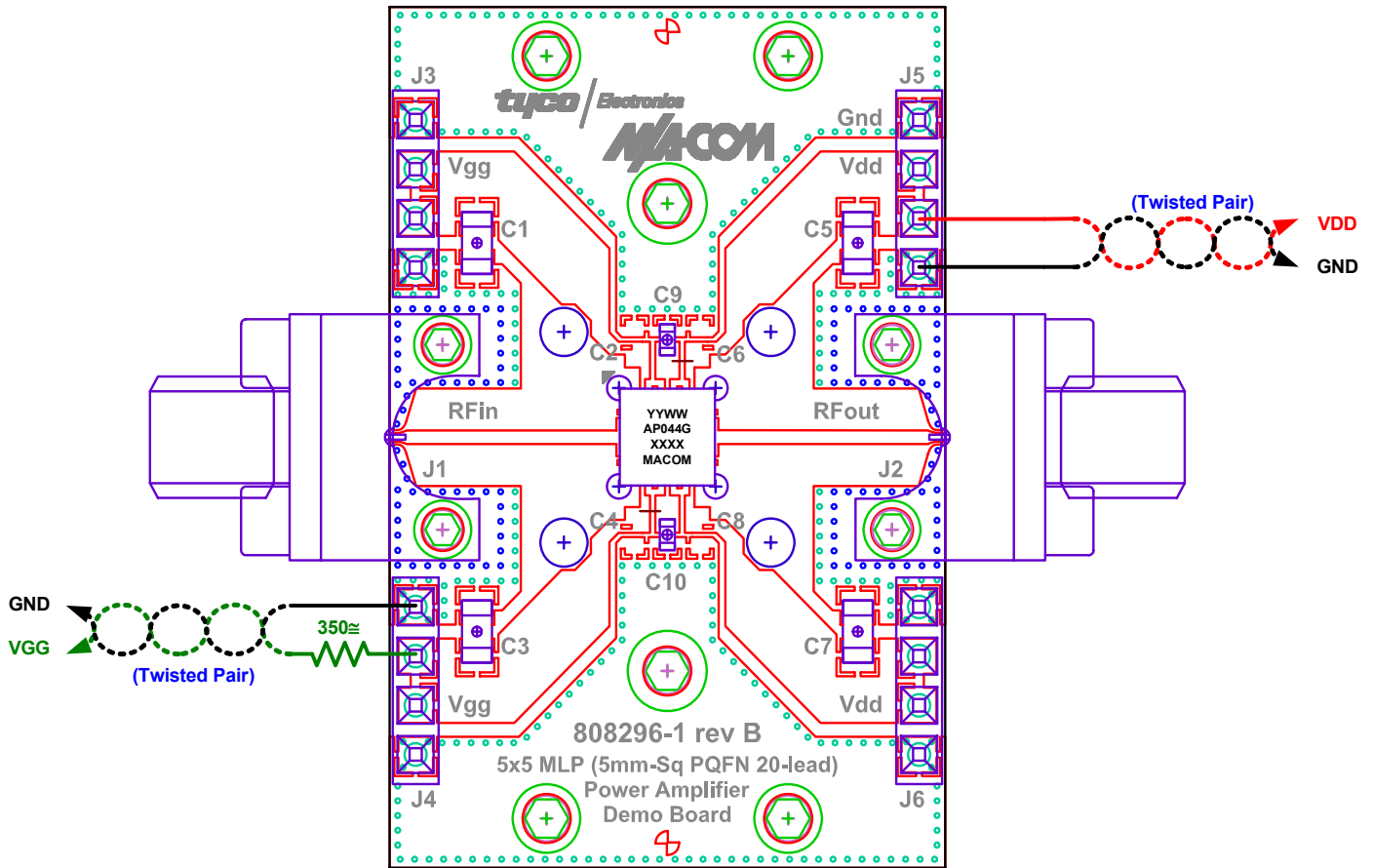

Figure 29. Demonstration Board PN MAAP-000044-SMB003 (available upon request).