

### Typical Applications

The HMC-C017 Wideband LNA is ideal for:

- Telecom Infrastructure
- Microwave Radio & VSAT
- Military & Space
- Test Instrumentation
- Fiber Optics

### Functional Diagram

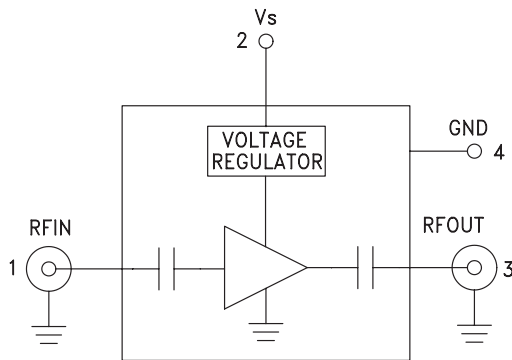

### Features

- Noise Figure: 2.75 dB
- Gain: 18 dB
- P1dB Output Power: +14 dBm
- 50 Ohm Matched Input/Output
- Regulated Supply:  $V_s = +8V$  to  $+16V$
- Hermetically Sealed Module
- Field Replaceable 2.92 mm Connectors
- 55 to  $+85^\circ C$  Operating Temperature

### General Description

The HMC-C017 is a GaAs MMIC PHEMT Low Noise Amplifier in a miniature, hermetic module which operates between 17 and 27 GHz. This high dynamic range amplifier module provides 18 dB of gain, 2.75 dB noise figure and up to +25 dBm of output IP3 while the internal voltage regulator accepts a supply voltage from +8V to +16V. The wideband amplifier I/Os are internally matched to 50 Ohms and are internally DC blocked for robust performance. The module features removable coaxial connectors which can be detached to allow direct connection of the I/O pins to a microstrip or coplanar circuit.

### Electrical Specifications, $T_A = +25^\circ C$ , $V_s = +8V$ to $+16V$

Parameter	Min.	Typ.	Max.	Min.	Typ.	Max.	Units
Frequency Range	17 - 22		22 - 27				GHz
Gain	16	19		14.5	17.5		dB
Gain Variation Over Temperature		0.015	0.025		0.015	0.025	dB/ °C
Noise Figure		2.75	3.25		3.0	4.0	dB
Input Return Loss		14			14		dB
Output Return Loss		10			13		dB
Output Power for 1 dB Compression (P1dB)	10.5	13.5		12	15		dBm
Saturated Output Power (Psat)		18			18.5		dBm
Output Third Order Intercept (IP3)		24			26		dBm
Supply Current		96			96		mA

**WIDEBAND LNA MODULE, 17 - 27 GHz**

**Gain & Return Loss**

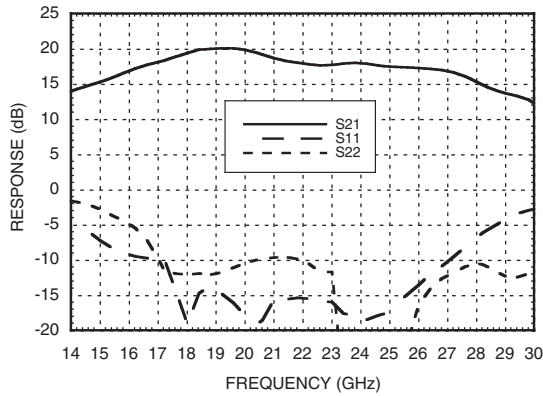

**Gain vs. Temperature**

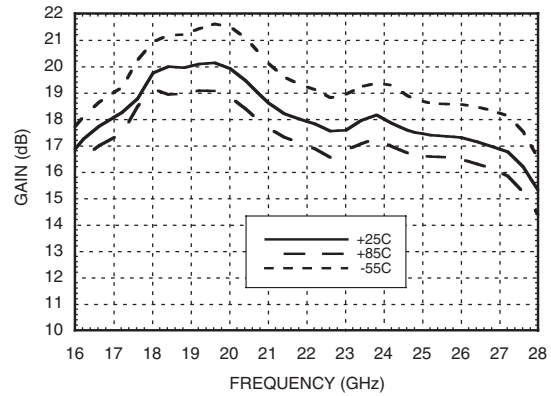

**Input Return Loss vs. Temperature**

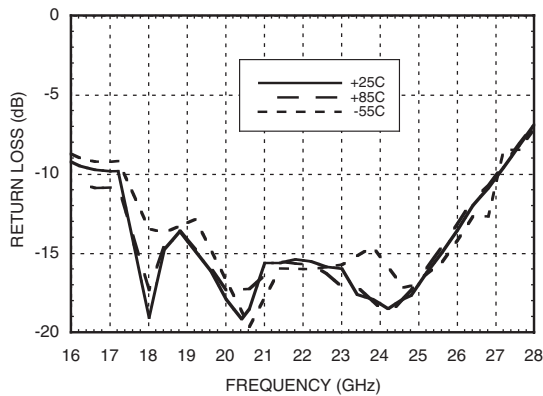

**Output Return Loss vs. Temperature**

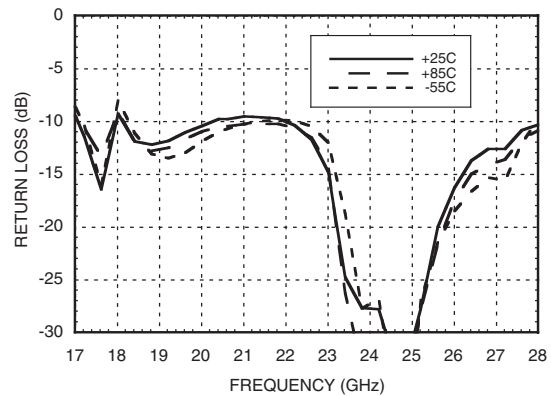

**Reverse Isolation vs. Temperature**

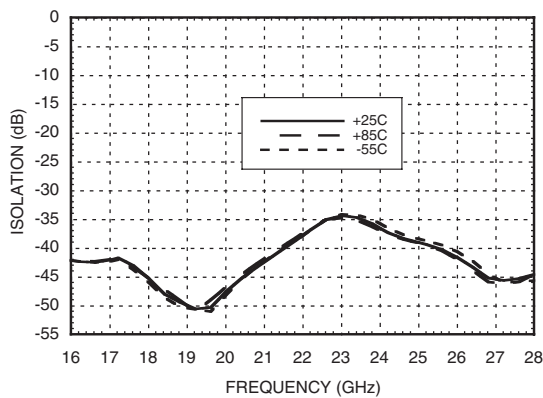

**Noise Figure vs. Temperature**

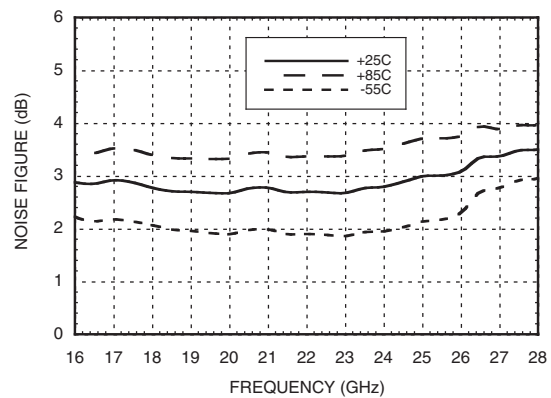

**P1dB vs. Temperature**

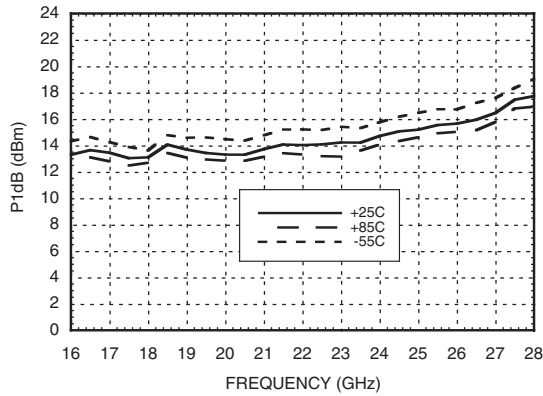

**Psat vs. Temperature**

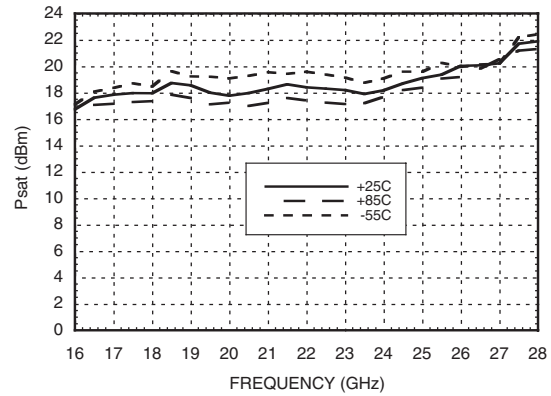

**Output IP3 vs. Temperature**

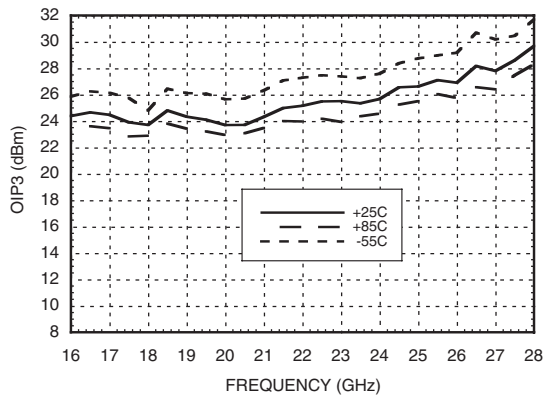

**Power Compression @ 21 GHz**

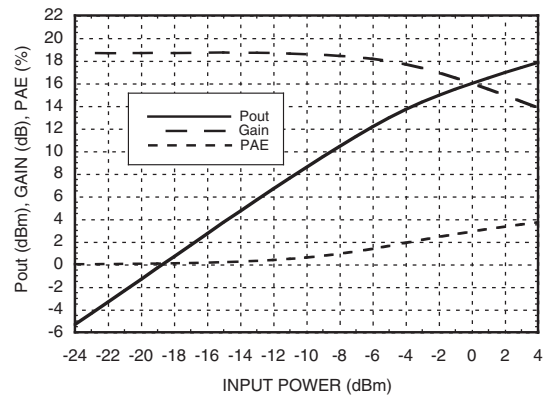



**Absolute Maximum Ratings**

Bias Supply Voltage (Vs)	-0.3 Vdc to +25 Vdc
RF Input Power (RFin)	+10 dBm
Storage Temperature	-65 to +150 °C
Operating Temperature	-55 to +85 °C

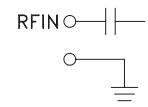
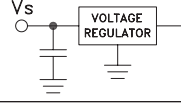
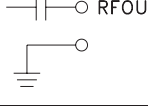

**ELECTROSTATIC SENSITIVE DEVICE  
OBSERVE HANDLING PRECAUTIONS**

**Pin Descriptions**

Pin Number	Function	Description	Interface Schematic
1	RFIN & RF Ground	RF input connector, coaxial female, field replaceable. This pin is AC coupled and matched to 50 Ohms from 17 - 27 GHz.	
2	Vs	Power supply voltage for the amplifier.	
3	RFOUT & RF Ground	RF output connector, coaxial female, field replaceable. This pin is AC coupled and matched to 50 Ohms from 17 - 27 GHz.	
4	GND	Power supply ground.	

**Outline Drawing**

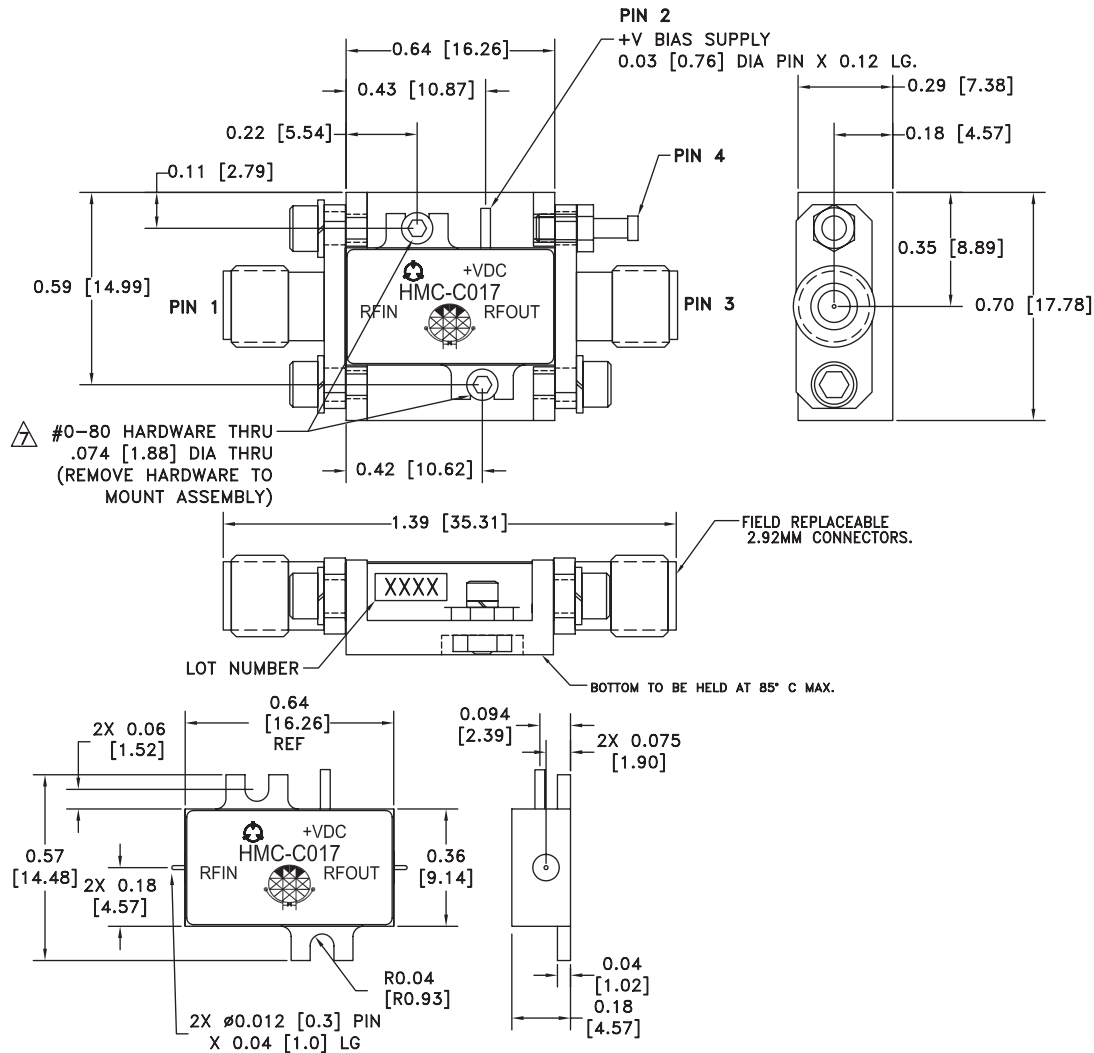

**NOTES:**

1. PACKAGE, LEADS, COVER MATERIAL: KOVAR™
  2. SPACER MATERIAL: ALUMINUM
  3. PLATING: ELECTROLYTIC GOLD 50 MICROINCHES MIN., OVER ELECTROLYTIC NICKEL 75 MICROINCHES MIN.
  4. ALL DIMENSIONS ARE IN INCHES [MILLIMETERS].
  5. TOLERANCES ±.005 [0.13] UNLESS OTHERWISE SPECIFIED.
  6. FIELD REPLACEABLE 2.92mm CONNECTORS. TENSOLITE 231CCSF OR EQUIVALENT.
- △ TO MOUNT MODULE TO SYSTEM PLATFORM REPLACE 0 -80 HARDWARE WITH DESIRED MOUNTING SCREWS.

**Notes:**