



**AO4420, AO4420L ( Green Product )**  
**N-Channel Enhancement Mode Field Effect Transistor**

**General Description**

The AO4420 uses advanced trench technology to provide excellent  $R_{DS(ON)}$ , shoot-through immunity and body diode characteristics. This device is suitable for use as a synchronous switch in PWM applications. AO4420L is offered in a lead-free package. AO4420L ( Green Product ) is offered in a lead-free package.

**Features**

$V_{DS}$  (V) = 30V  
 $I_D$  = 13.7A  
 $R_{DS(ON)} < 10.5m\Omega$  ( $V_{GS} = 10V$ )  
 $R_{DS(ON)} < 12m\Omega$  ( $V_{GS} = 4.5V$ )

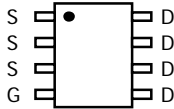

**SOIC-8**

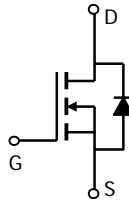

**Absolute Maximum Ratings**  $T_A=25^\circ\text{C}$  unless otherwise noted

Parameter	Symbol	Maximum	Units
Drain-Source Voltage	$V_{DS}$	30	V
Gate-Source Voltage	$V_{GS}$	$\pm 12$	V
Continuous Drain Current <sup>A</sup>	$I_D$	$T_A=25^\circ\text{C}$	A
		$T_A=70^\circ\text{C}$	
Pulsed Drain Current <sup>B</sup>	$I_{DM}$	60	
Power Dissipation	$P_D$	$T_A=25^\circ\text{C}$	W
		$T_A=70^\circ\text{C}$	
Junction and Storage Temperature Range	$T_J, T_{STG}$	-55 to 150	$^\circ\text{C}$

**Thermal Characteristics**

Parameter	Symbol	Typ	Max	Units	
Maximum Junction-to-Ambient <sup>A</sup>	$R_{\theta JA}$	$t \leq 10s$	28	40	$^\circ\text{C/W}$
		Steady-State	54	75	$^\circ\text{C/W}$
Maximum Junction-to-Lead <sup>C</sup>	$R_{\theta JL}$	21	30	$^\circ\text{C/W}$	

Electrical Characteristics ( $T_J=25^\circ\text{C}$  unless otherwise noted)

Symbol	Parameter	Conditions	Min	Typ	Max	Units
<b>STATIC PARAMETERS</b>						
$BV_{DSS}$	Drain-Source Breakdown Voltage	$I_D=250\mu\text{A}$ , $V_{GS}=0\text{V}$	30			V
$I_{DSS}$	Zero Gate Voltage Drain Current	$V_{DS}=24\text{V}$ , $V_{GS}=0\text{V}$ $T_J=55^\circ\text{C}$		0.004	1	$\mu\text{A}$
$I_{GSS}$	Gate-Body leakage current	$V_{DS}=0\text{V}$ , $V_{GS}=\pm 12\text{V}$			100	nA
$V_{GS(th)}$	Gate Threshold Voltage	$V_{DS}=V_{GS}$ , $I_D=250\mu\text{A}$	0.6	1.1	2	V
$I_{D(ON)}$	On state drain current	$V_{GS}=4.5\text{V}$ , $V_{DS}=5\text{V}$	40			A
$R_{DS(ON)}$	Static Drain-Source On-Resistance	$V_{GS}=10\text{V}$ , $I_D=13.7\text{A}$ $T_J=125^\circ\text{C}$		8.3	10.5	$\text{m}\Omega$
		$V_{GS}=4.5\text{V}$ , $I_D=12.7\text{A}$		12.5	15	$\text{m}\Omega$
$g_{FS}$	Forward Transconductance	$V_{DS}=5\text{V}$ , $I_D=13.7\text{A}$	30	37		S
$V_{SD}$	Diode Forward Voltage	$I_S=1\text{A}$ , $V_{GS}=0\text{V}$		0.76	1	V
$I_S$	Maximum Body-Diode Continuous Current				5	A
<b>DYNAMIC PARAMETERS</b>						
$C_{iss}$	Input Capacitance	$V_{GS}=0\text{V}$ , $V_{DS}=15\text{V}$ , $f=1\text{MHz}$		3656	4050	pF
$C_{oss}$	Output Capacitance			256		pF
$C_{rss}$	Reverse Transfer Capacitance			168		pF
$R_g$	Gate resistance	$V_{GS}=0\text{V}$ , $V_{DS}=0\text{V}$ , $f=1\text{MHz}$		0.86	1.1	$\Omega$
<b>SWITCHING PARAMETERS</b>						
$Q_g(4.5\text{V})$	Total Gate Charge	$V_{GS}=10\text{V}$ , $V_{DS}=15\text{V}$ , $I_D=13.7\text{A}$		30.5	36	nC
$Q_{gs}$	Gate Source Charge			4.6		nC
$Q_{gd}$	Gate Drain Charge			8.6		nC
$t_{D(on)}$	Turn-On Delay Time	$V_{GS}=10\text{V}$ , $V_{DS}=15\text{V}$ , $R_L=1.1\Omega$ , $R_{GEN}=0\Omega$		5.5	9	ns
$t_r$	Turn-On Rise Time			3.4	7	ns
$t_{D(off)}$	Turn-Off Delay Time			49.8	75	ns
$t_f$	Turn-Off Fall Time			5.9	11	ns
$t_{rr}$	Body Diode Reverse Recovery Time	$I_F=13.7\text{A}$ , $dI/dt=100\text{A}/\mu\text{s}$		22.5	28	ns
$Q_{rr}$	Body Diode Reverse Recovery Charge	$I_F=13.7\text{A}$ , $dI/dt=100\text{A}/\mu\text{s}$		12.5	16	nC

A: The value of  $R_{\theta JA}$  is measured with the device mounted on 1in<sup>2</sup> FR-4 board with 2oz. Copper, in a still air environment with  $T_A=25^\circ\text{C}$ . The value in any a given application depends on the user's specific board design. The current rating is based on the  $t \leq 10\text{s}$  thermal resistance rating.

B: Repetitive rating, pulse width limited by junction temperature.

C: The  $R_{\theta JA}$  is the sum of the thermal impedance from junction to lead  $R_{\theta JL}$  and lead to ambient.

D: The static characteristics in Figures 1 to 6 are obtained using 80 $\mu\text{s}$  pulses, duty cycle 0.5% max.

E: These tests are performed with the device mounted on 1 in<sup>2</sup> FR-4 board with 2oz. Copper, in a still air environment with  $T_A=25^\circ\text{C}$ . The SOA curve provides a single pulse rating.

THIS PRODUCT HAS BEEN DESIGNED AND QUALIFIED FOR THE CONSUMER MARKET. APPLICATIONS OR USES AS CRITICAL COMPONENTS IN LIFE SUPPORT DEVICES OR SYSTEMS ARE NOT AUTHORIZED. AOS DOES NOT ASSUME ANY LIABILITY ARISING OUT OF SUCH APPLICATIONS OR USES OF ITS PRODUCTS. AOS RESERVES THE RIGHT TO IMPROVE PRODUCT DESIGN, FUNCTIONS AND RELIABILITY WITHOUT NOTICE.

TYPICAL ELECTRICAL AND THERMAL CHARACTERISTICS

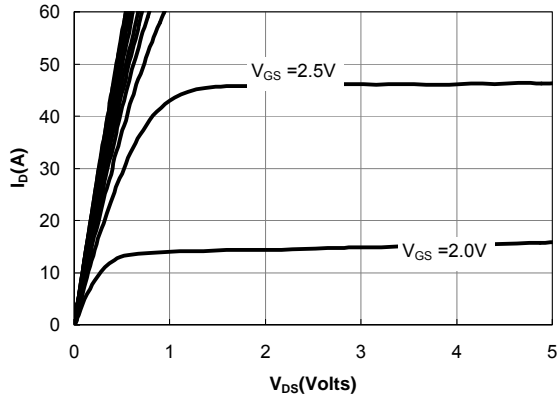

Figure 1: On-Regions Characteristics

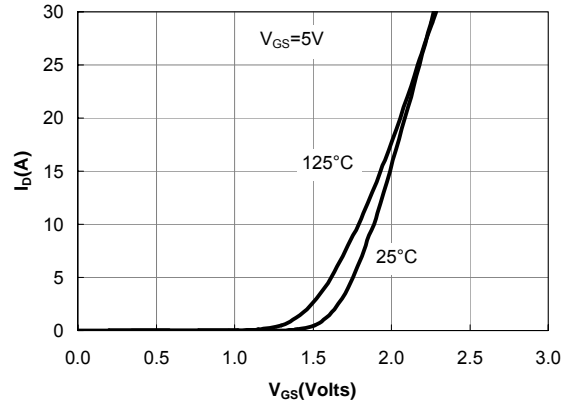

Figure 2: Transfer Characteristics

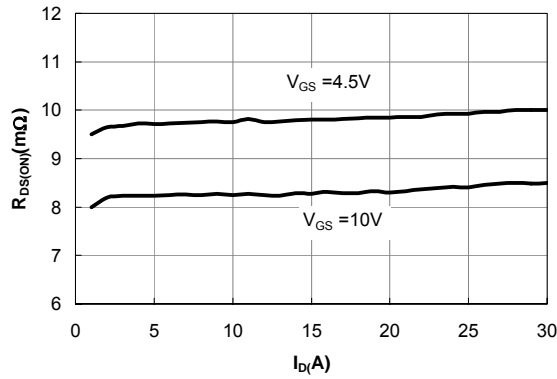

Figure 3: On-Resistance vs. Drain Current and Gate Voltage

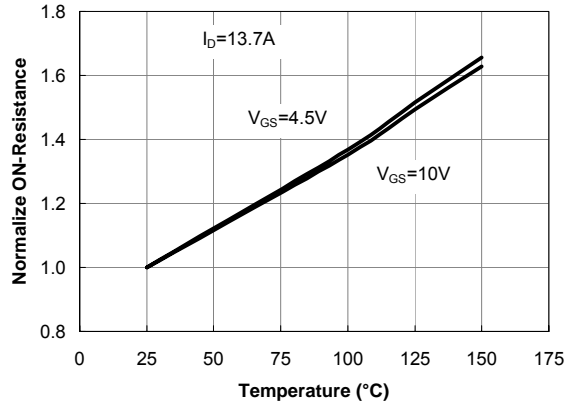

Figure 4: On-Resistance vs. Junction Temperature

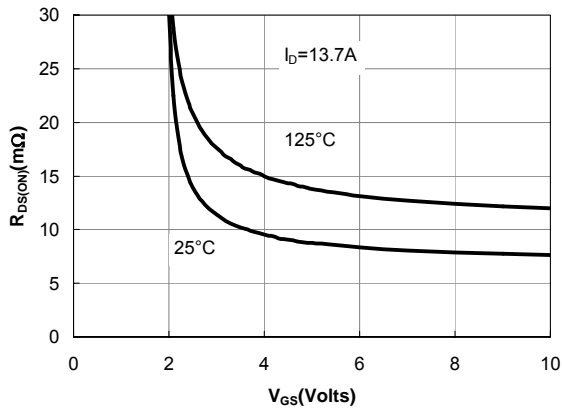

Figure 5: On-Resistance vs. Gate-Source Voltage

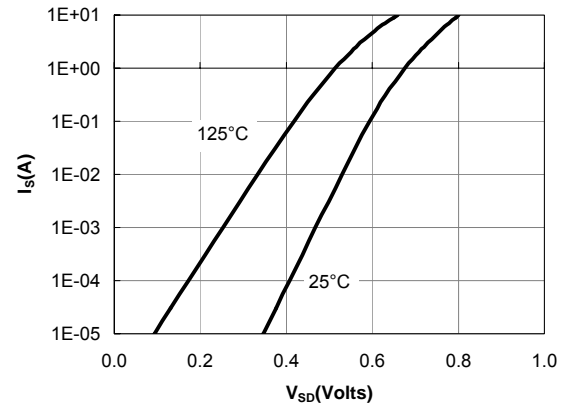

Figure 6: Body-Diode Characteristics

TYPICAL ELECTRICAL AND THERMAL CHARACTERISTICS

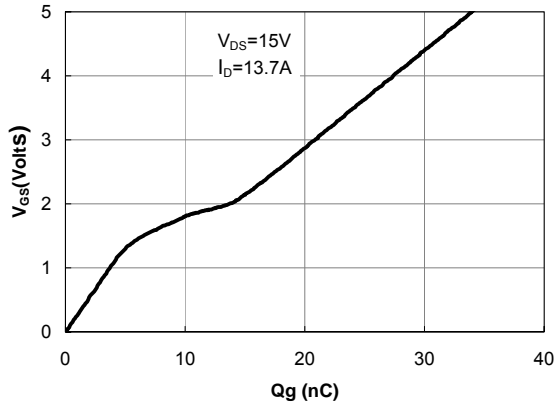

Figure 7: Gate-Charge Characteristics

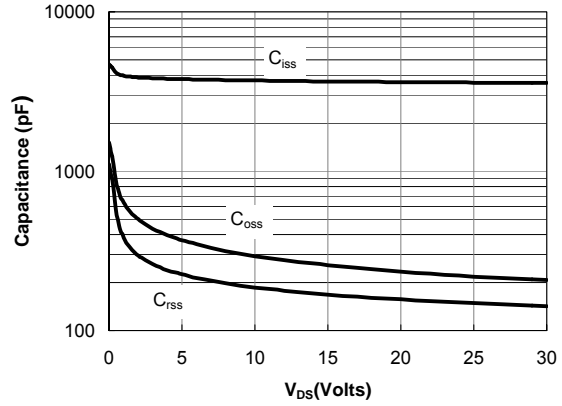

Figure 8: Capacitance Characteristics

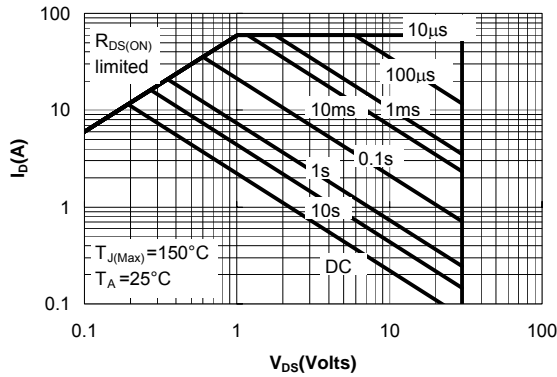

Figure 9: Maximum Forward Biased Safe Operating Area (Note E)

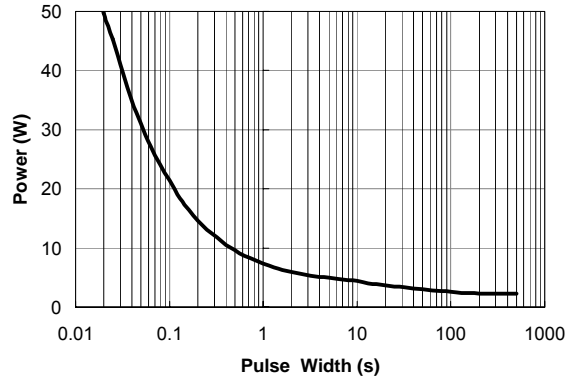

Figure 10: Single Pulse Power Rating Junction-to-Ambient (Note E)

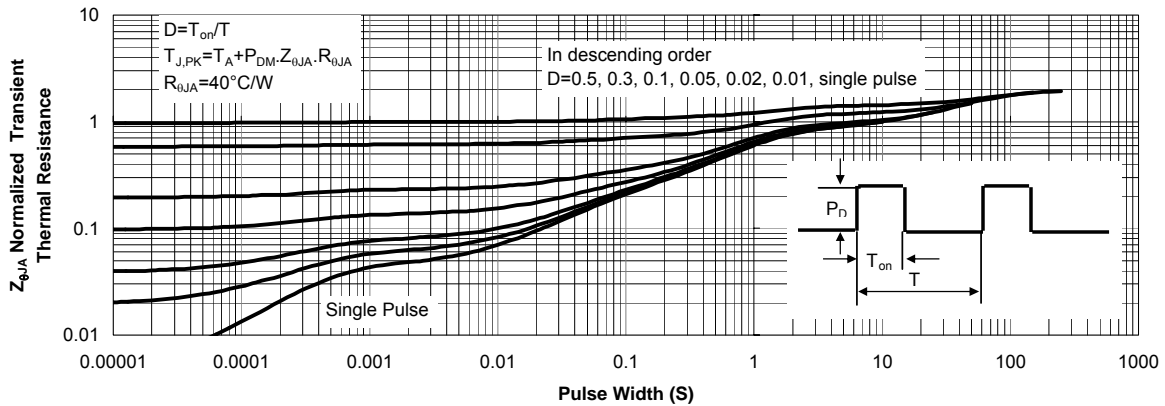

Figure 11: Normalized Maximum Transient Thermal Impedance



**ALPHA & OMEGA**  
*SEMICONDUCTOR, LTD.*

Document No.	PD-00139
Version	rev C
Title	AO4420 Marking Description

SO-8 PACKAGE MARKING DESCRIPTION

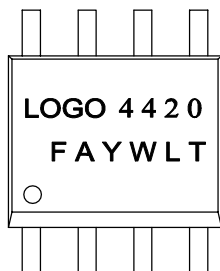

Standard product



Green product

NOTE:

LOGO - AOS LOGO  
4420 - PART NUMBER CODE.  
F&A - FOUNDRY AND ASSEMBLY LOCATION  
Y - YEAR CODE  
W - WEEK CODE.  
L T - ASSEMBLY LOT CODE

PART NO.	DESCRIPTION	CODE
AO4420	Standard product	4420
AO4420L	Green product	<u>4420</u>

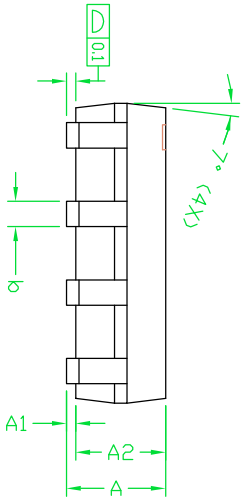
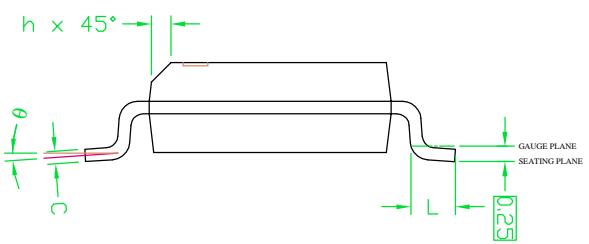
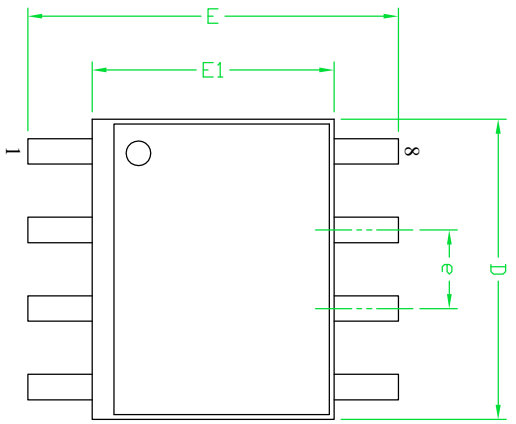

**RECOMMENDED LAND PATTERN**

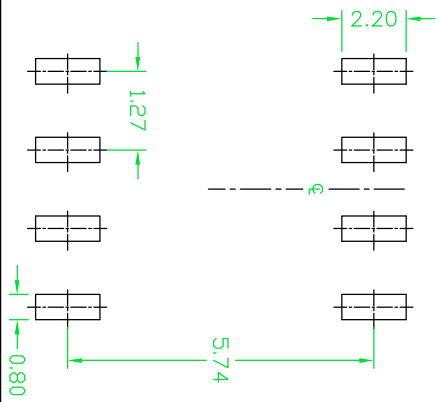

- NOTE**
1. ALL DIMENSIONS ARE IN MILLIMETERS.
  2. DIMENSIONS ARE INCLUSIVE OF PLATING.
  3. PACKAGE BODY SIZES EXCLUDE MOLD FLASH AND GATE BURRS.
  4. DIMENSION L IS MEASURED IN GAUGE PLANE.
  5. CONTROLLING DIMENSION IS MILLIMETER, CONVERTED INCH DIMENSIONS ARE NOT NECESSARILY EXACT.

SYMBOLS	DIMENSIONS IN MILLIMETERS			DIMENSIONS IN INCHES		
	MIN	NOM	MAX	MIN	NOM	MAX
A	1.35	1.65	1.75	0.053	0.065	0.069
A1	0.10	—	0.25	0.004	—	0.010
A2	1.25	1.50	1.65	0.049	0.059	0.065
b	0.31	—	0.51	0.012	—	0.020
c	0.17	—	0.25	0.007	—	0.010
D	4.80	4.90	5.00	0.189	0.193	0.197
E1	3.80	3.90	4.00	0.150	0.154	0.157
e	1.27 BSC			0.050 BSC		
E	5.80	6.00	6.20	0.228	0.236	0.244
h	0.25	—	0.50	0.010	—	0.020
L	0.40	—	1.27	0.016	—	0.050
θ	0°	—	8°	0°	—	8°

**UNIT: mm**

UNLESS OTHERWISE SPECIFIED DIMENSIONS ARE IN INCHES DECIMAL                      ANGULAR X.X ±                              ± X.XX ± X.XXX ± X.XXX ± INTERPRET DIM AND TOL PER ASME Y14.5M - 1994		
	THIRD ANGLE PROJECTION	
PRINTING IS SCALED TO FIT DO NOT SCALE DRAWING	Title	SO-8 PACKAGE OUTLINE



**ALPHA & OMEGA**  
SEMICONDUCTOR, LTD.

## SO-8 Tape and Reel Data

### SO-8 Carrier Tape

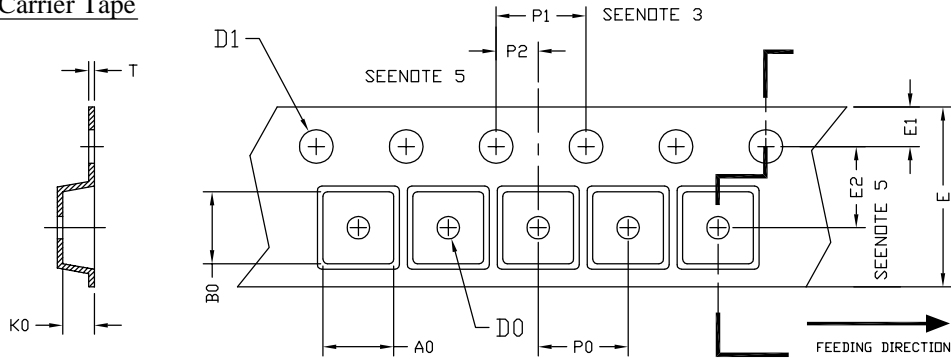

UNIT: MM

PACKAGE	A0	B0	K0	D0	D1	E	E1	E2	P0	P1	P2	T
SD-8 (12 mm)	6.40 ±0.10	5.20 ±0.10	2.10 ±0.10	1.60 ±0.10	1.50 +0.10	12.00 ±0.30	1.75 ±0.10	5.50 ±0.05	8.00 ±0.10	4.00 ±0.10	2.00 ±0.05	0.25 ±0.05

### SO-8 Reel

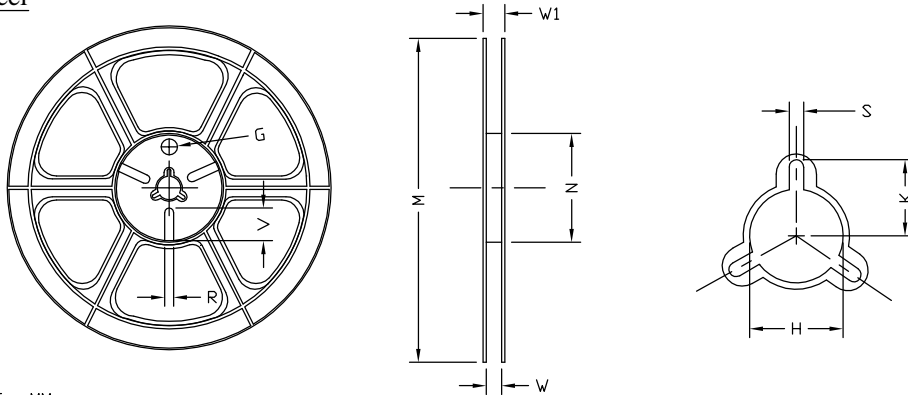

UNIT: MM

TAPE SIZE	REEL SIZE	M	N	W	W1	H	K	S	G	R	V
12 mm	ø330	ø330.00 ±0.50	ø97.00 ±0.10	13.00 ±0.30	17.40 ±1.00	ø13.00 +0.50 -0.20	10.60	2.00 ±0.50	---	---	---

### SO-8 Tape

Leader / Trailer  
& Orientation

