

## High Speed Infrared Emitting Diode, 850 nm, GaAlAs Double Hetero

### Description

TSHG6200 is a high speed infrared emitting diode in GaAlAs double hetero (DH) technology, molded in a clear, untinted plastic package.

The new technology combines high speed with high radiant power at wavelength of 850 nm.

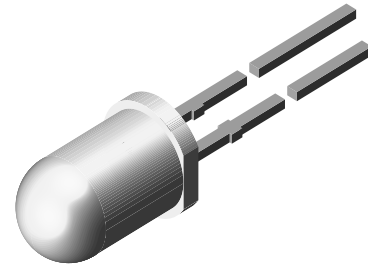

94 8390

### Features

- High modulation bandwidth
- Extra high radiant power and radiant intensity
- Low forward voltage
- Suitable for high pulse current operation
- Standard package T-1 $\frac{3}{4}$  ( $\varnothing$  5 mm)
- Angle of half intensity  $\varphi = \pm 10^\circ$
- Peak wavelength  $\lambda_p = 850$  nm
- High reliability
- Good spectral matching to Si photodetectors
- Lead-free component
- Component in accordance to RoHS 2002/95/EC and WEEE 2002/96/EC

### Applications

Infrared radiation source for CMOS cameras (illumination). High speed IR data transmission.

### Parts Table

Part	Remarks
TSHG6200	MOQ: 4000 pc

### Absolute Maximum Ratings

$T_{amb} = 25^\circ\text{C}$ , unless otherwise specified

Parameter	Test condition	Symbol	Value	Unit
Reverse Voltage		$V_R$	5	V
Forward current		$I_F$	100	mA
Peak Forward Current	$t_p/T = 0.5$ , $t_p = 100 \mu\text{s}$	$I_{FM}$	200	mA
Surge Forward Current	$t_p = 100 \mu\text{s}$	$I_{FSM}$	1	A
Power Dissipation		$P_V$	250	mW
Junction Temperature		$T_j$	100	$^\circ\text{C}$
Operating Temperature Range		$T_{amb}$	- 40 to + 85	$^\circ\text{C}$
Storage Temperature Range		$T_{stg}$	- 40 to + 100	$^\circ\text{C}$
Soldering Temperature	$t \leq 5$ sec, 2 mm from case	$T_{sd}$	260	$^\circ\text{C}$
Thermal Resistance Junction/Ambient		$R_{thJA}$	300	K/W

### Basic Characteristics

$T_{amb} = 25^\circ\text{C}$ , unless otherwise specified

Parameter	Test condition	Symbol	Min	Typ.	Max	Unit
Forward Voltage	$I_F = 100$ mA, $t_p = 20$ ms	$V_F$		1.5	1.8	V
	$I_F = 1$ A, $t_p = 100 \mu\text{s}$	$V_F$		2.3		V
Temp. Coefficient of $V_F$	$I_F = 100$ mA	$TK_{VF}$		-2.1		mV/K

Parameter	Test condition	Symbol	Min	Typ.	Max	Unit
Reverse Current	$V_R = 5\text{ V}$	$I_R$			10	$\mu\text{A}$
Junction capacitance	$V_R = 0\text{ V}$ , $f = 1\text{ MHz}$ , $E = 0$	$C_j$		125		pF
Radiant Intensity	$I_F = 100\text{ mA}$ , $t_p = 20\text{ ms}$	$I_e$	80	160	400	mW/sr
	$I_F = 1\text{ A}$ , $t_p = 100\ \mu\text{s}$	$I_e$		1600		mW/sr
Radiant Power	$I_F = 100\text{ mA}$ , $t_p = 20\text{ ms}$	$\phi_e$		50		mW
Temp. Coefficient of $\phi_e$	$I_F = 100\text{ mA}$	$\text{TK}\phi_e$		-0.35		%/K
Angle of Half Intensity		$\phi$		$\pm 10$		deg
Peak Wavelength	$I_F = 100\text{ mA}$	$\lambda_p$		850		nm
Spectral Bandwidth	$I_F = 100\text{ mA}$	$\Delta\lambda$		40		nm
Temp. Coefficient of $\lambda_p$	$I_F = 100\text{ mA}$	$\text{TK}\lambda_p$		0.25		nm/K
Rise Time	$I_F = 100\text{ mA}$	$t_r$		20		ns
Fall Time	$I_F = 100\text{ mA}$	$t_f$		13		ns
Cut-Off Frequency	$I_{DC} = 70\text{ mA}$ , $I_{AC} = 30\text{ mA pp}$	$f_c$		20		MHz
Virtual Source Diameter		$\varnothing$		3.7		mm

### Typical Characteristics ( $T_{amb} = 25\text{ }^\circ\text{C}$ unless otherwise specified)

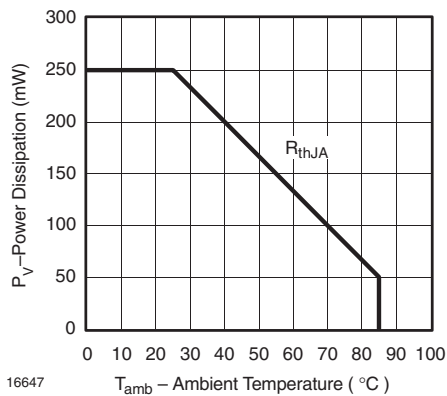

Figure 1. Power Dissipation vs. Ambient Temperature

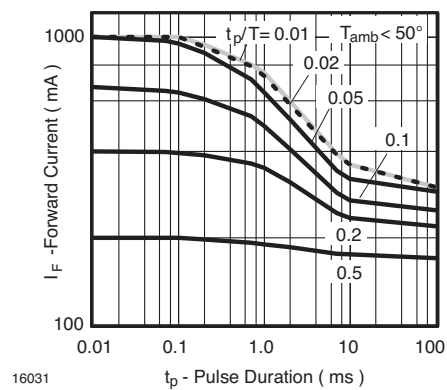

Figure 3. Pulse Forward Current vs. Pulse Duration

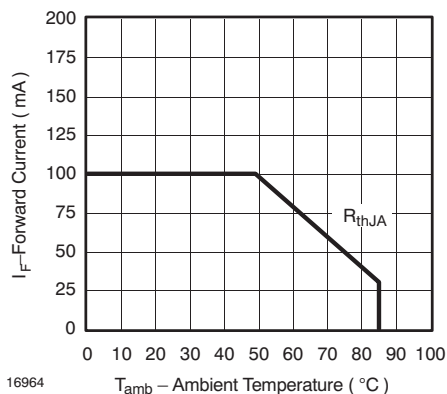

Figure 2. Forward Current vs. Ambient Temperature

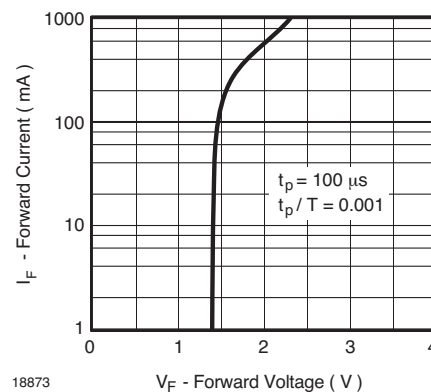

Figure 4. Forward Current vs. Forward Voltage

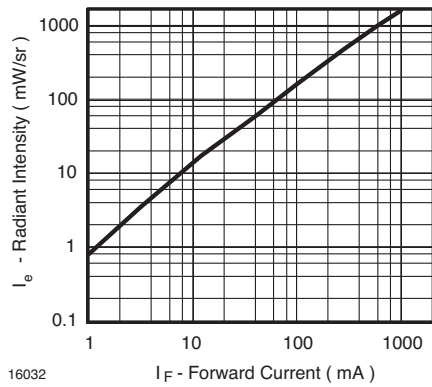

Figure 5. Radiant Intensity vs. Forward Current

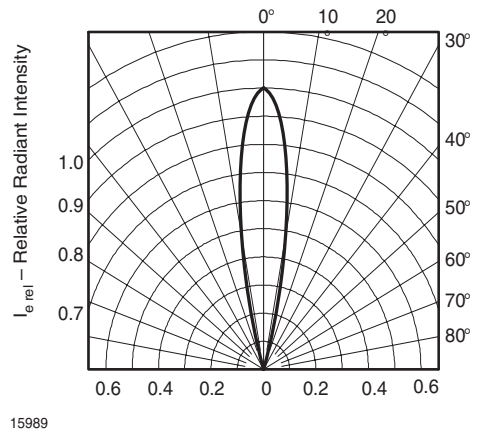

Figure 8. Relative Radiant Intensity vs. Angular Displacement

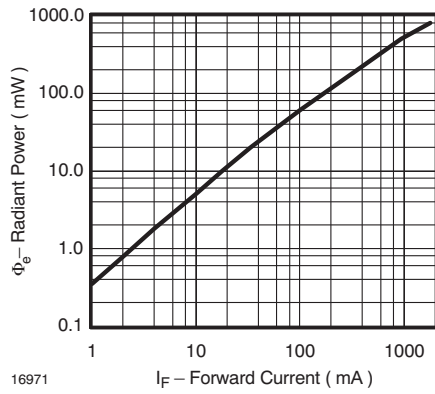

Figure 6. Radiant Power vs. Forward Current

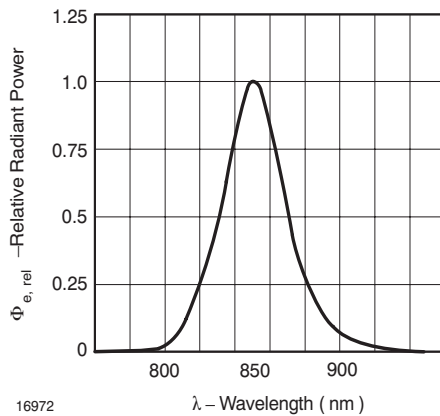
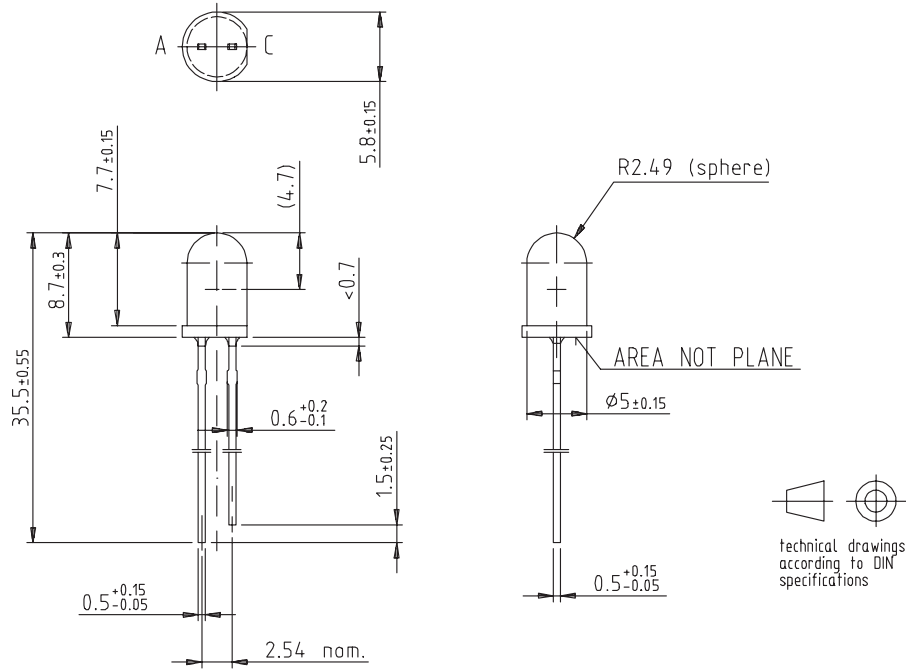

Figure 7. Relative Radiant Power vs. Wavelength

## Package Dimensions in mm



95 10917



## Ozone Depleting Substances Policy Statement

It is the policy of Vishay Semiconductor GmbH to

1. Meet all present and future national and international statutory requirements.
2. Regularly and continuously improve the performance of our products, processes, distribution and operating systems with respect to their impact on the health and safety of our employees and the public, as well as their impact on the environment.

It is particular concern to control or eliminate releases of those substances into the atmosphere which are known as ozone depleting substances (ODSs).

The Montreal Protocol (1987) and its London Amendments (1990) intend to severely restrict the use of ODSs and forbid their use within the next ten years. Various national and international initiatives are pressing for an earlier ban on these substances.

Vishay Semiconductor GmbH has been able to use its policy of continuous improvements to eliminate the use of ODSs listed in the following documents.

1. Annex A, B and list of transitional substances of the Montreal Protocol and the London Amendments respectively
2. Class I and II ozone depleting substances in the Clean Air Act Amendments of 1990 by the Environmental Protection Agency (EPA) in the USA
3. Council Decision 88/540/EEC and 91/690/EEC Annex A, B and C (transitional substances) respectively.

Vishay Semiconductor GmbH can certify that our semiconductors are not manufactured with ozone depleting substances and do not contain such substances.

We reserve the right to make changes to improve technical design and may do so without further notice.

Parameters can vary in different applications. All operating parameters must be validated for each customer application by the customer. Should the buyer use Vishay Semiconductors products for any unintended or unauthorized application, the buyer shall indemnify Vishay Semiconductors against all claims, costs, damages, and expenses, arising out of, directly or indirectly, any claim of personal damage, injury or death associated with such unintended or unauthorized use.

Vishay Semiconductor GmbH, P.O.B. 3535, D-74025 Heilbronn, Germany  
Telephone: 49 (0)7131 67 2831, Fax number: 49 (0)7131 67 2423