

μ A727 Temperature-Controlled Differential Preamp

Special Function Products

Description

The μ A727 is a monolithic, fixed gain, Differential Input/Output Preamp, constructed with the Fairchild Planar epitaxial process, mounted in a high thermal resistance package, and held at constant temperature by active regulator circuitry. The high gain and low-standby dissipation of the regulator circuit give tight temperature control over a wide ambient temperature range. The device is intended for use as a self-contained input stage in very low drift dc amplifiers, replacing complex chopper-stabilized amplifiers in such applications as thermo-couple bridges, strain-gauge transducers, and a/d converters.

- **VERY LOW OFFSET DRIFTS**
- **HIGH INPUT IMPEDANCE 300 M Ω**
- **WIDE COMMON MODE RANGE $C_{MRR} = 100$ dB**

Absolute Maximum Ratings

Operating Temperature Range	
Military (μ A727)	-55°C to +125°C
Commercial (μ A727C)	-20°C to +85°C
Storage Temperature Range	-65°C to +150°C
Pin Temperature (Soldering, 60 s)	300°C
Internal Power Dissipation	500 mW
Supply Voltage	
(Amplifier and Heater)	± 18 V
Differential Input Voltage	± 10 V
Common Mode Input Voltage	± 15 V

Connection Diagram 10-Pin Metal Package

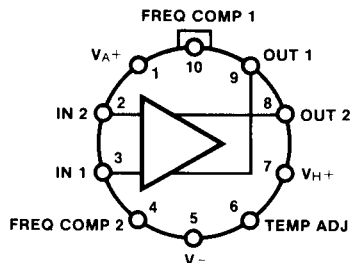

(Top View)

Order Information

Type	Package	Code	Part No.
μ A727	Metal	5U	μ A727HM
μ A727C	Metal	5U	μ A727HC

Equivalent Circuit

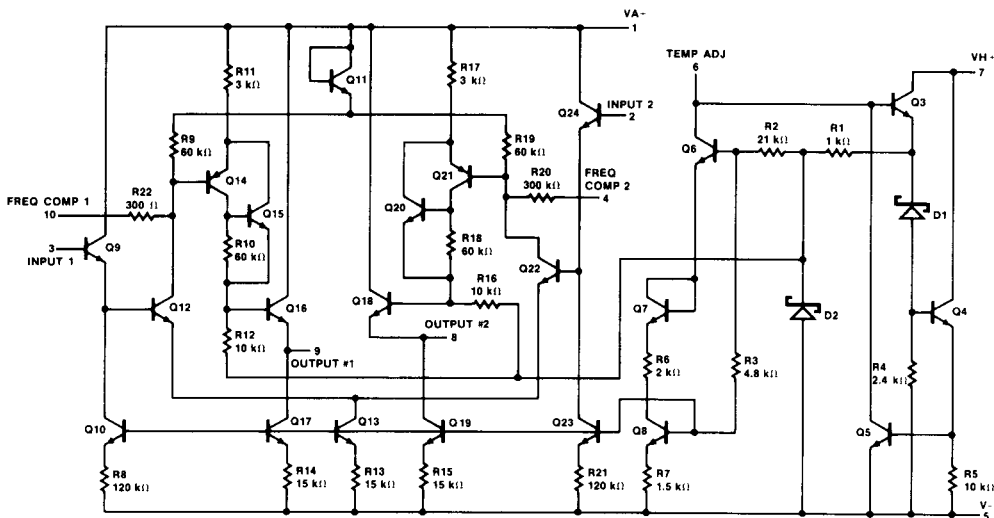

μA727

Electrical Characteristics

$-55^{\circ}\text{C} \leq T_A \leq +125^{\circ}\text{C}$, $V_{H+} = +15\text{ V}$, $V_{-} = -15\text{ V}$, $R_{ADJ} = 330\text{ k}\Omega$, unless otherwise specified.

Characteristic	Condition	Min	Typ	Max	Unit
Input Offset Voltage	$R_S \leq 50\ \Omega$		2.0	10	mV
Input Offset Current			2.5	15	nA
Input Bias Current			12	40	nA
Input Offset Voltage Drift	$R_S \leq 50\ \Omega$, $+25^{\circ}\text{C} \leq T_A \leq +125^{\circ}\text{C}$		0.6	1.5	$\mu\text{V}/^{\circ}\text{C}$
	$R_S \leq 50\ \Omega$, $-55^{\circ}\text{C} \leq T_A \leq +25^{\circ}\text{C}$		0.6	1.5	$\mu\text{V}/^{\circ}\text{C}$
Input Offset Current Drift	$+25^{\circ}\text{C} \leq T_A \leq +125^{\circ}\text{C}$		2.0		$\text{pA}/^{\circ}\text{C}$
	$-55^{\circ}\text{C} \leq T_A \leq +25^{\circ}\text{C}$		2.0		$\text{pA}/^{\circ}\text{C}$
Input Bias Current Drift	$-55^{\circ}\text{C} \leq T_A \leq +125^{\circ}\text{C}$		15		$\text{pA}/^{\circ}\text{C}$
Differential Input Resistance			300		$\text{M}\Omega$
Common-Mode Input Resistance			1000		$\text{M}\Omega$
Input Voltage Range		± 12	± 13		V
Supply Voltage Rejection Ratio	$R_S \leq 100\text{ k}\Omega$		80		$\mu\text{V}/\text{V}$
Common-Mode Rejection Ratio	$R_S \leq 100\text{ k}\Omega$	80	100		dB
Output Resistance			1.0	4.0	$\text{k}\Omega$
Output Common-Mode Voltage		-6.0	-5.0	-4.0	V
Differential Output Voltage Swing		± 5.0	± 7.0	± 10	V
Output Sink Current		10	30	80	μA
Differential Load Rejection			5.0	10	$\mu\text{V}/\mu\text{A}$
Differential Voltage Gain		60	100	250	
Low Frequency Noise	$\text{BW} = 10\text{ Hz to }500\text{ Hz}$, $R_S \leq 50\ \Omega$		3.0		μV_{rms}
Long Term Drift	$R_S \leq 50\ \Omega$		5.0		$\mu\text{V}/\text{week}$
Amplifier Supply Current	$T_A = +25^{\circ}\text{C}$		1.0	2.0	mA
Heater Supply Current	$T_A = +25^{\circ}\text{C}$		10	15	mA

μA727C

Electrical Characteristics $-20^{\circ}\text{C} \leq T_A \leq +85^{\circ}\text{C}$, $V_{H+} = V_{A+} = +15\text{ V}$, $V_{-} = -15\text{ V}$, $R_{ADJ} = 1\text{ M}\Omega$, unless otherwise specified.

Characteristic	Condition	Min	Typ	Max	Unit
Input Offset Voltage	$R_S \leq 50\ \Omega$		2.0	10	mV
Input Offset Current			2.5	25	nA
Input Bias Current			12	75	nA
Input Offset Voltage Drift	$R_S \leq 50\ \Omega$		0.6	3.0	$\mu\text{V}/^{\circ}\text{C}$
Input Offset Current Drift			2.0		$\text{pA}/^{\circ}\text{C}$
Input Bias Current Drift			15		$\text{pA}/^{\circ}\text{C}$
Differential Input Resistance			300		$\text{M}\Omega$
Common Mode Input Resistance			1000		$\text{M}\Omega$
Input Voltage Range		± 12	± 13		V
Supply Voltage Rejection Ratio	$R_S \leq 100\ \text{k}\Omega$		80		$\mu\text{V}/\text{V}$
Common Mode Rejection Ratio	$R_S \leq 100\ \text{k}\Omega$	70	100		dB
Output Resistance			1.0	4.0	$\text{k}\Omega$
Output Common Mode Voltage		-7.0	-5.0	-4.0	V
Differential Output Voltage Swing		± 3.0	± 7.0	± 10	V
Output Sink Current		10	30	80	μA
Differential Load Rejection			5.0	15	$\mu\text{V}/\mu\text{A}$
Differential Voltage Gain		50	100	250	
Low Frequency Noise	$\text{BW} = 10\ \text{Hz to } 500\ \text{Hz}$, $R_S \leq 50\ \Omega$		3.0		μV_{rms}
Long Term Drift	$R_S \leq 50\ \Omega$		5.0		$\mu\text{V}/\text{week}$
Amplifier Supply Current	$T_A = +25^{\circ}\text{C}$		1.0	2.0	mA
Heater Supply Current	$T_A = +25^{\circ}\text{C}$		10	15	mA

Typical Performance Curves

Noise Voltage vs Frequency

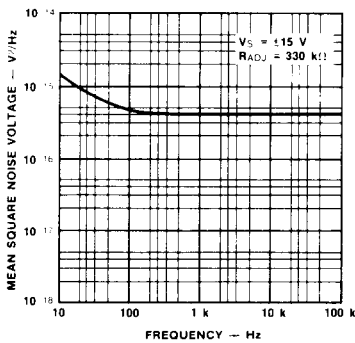

Noise Current vs Frequency

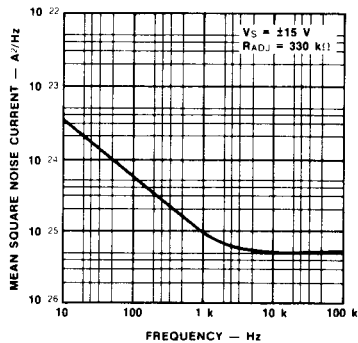

Spot Noise Contours

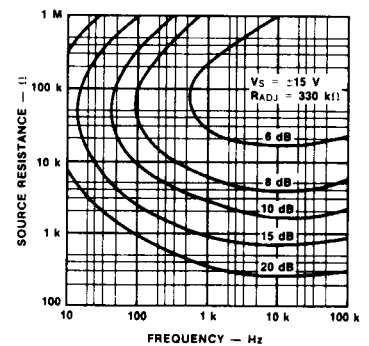

Typical Performance Curves (Cont.)

Recommended R_{ADJ} vs Maximum Ambient Temperature

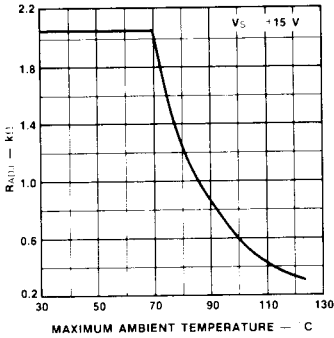

Relative Chip Temperature vs Ambient Temperature

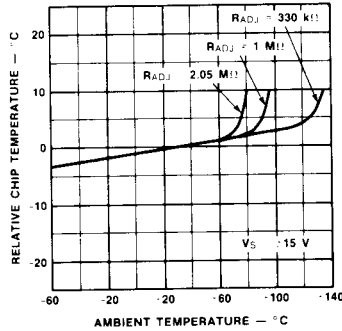

Power Consumption vs Ambient Temperature

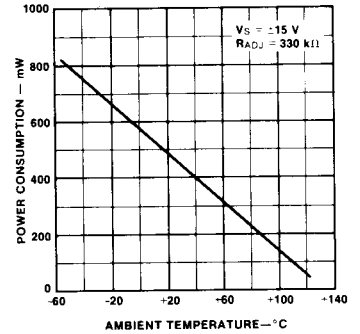

Input Common-Mode Voltage Range vs Supply Voltage

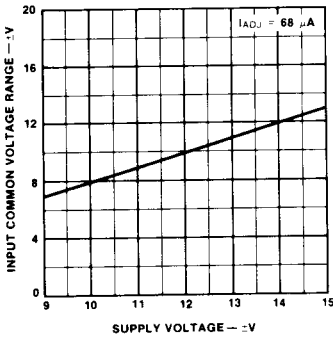

Output Common-Mode Voltage vs Supply Voltage

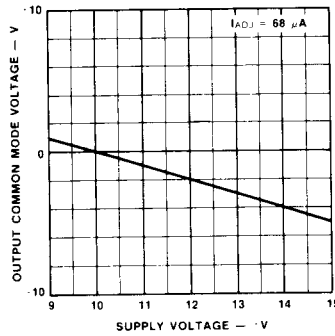

Amplifier Current vs Supply Voltage

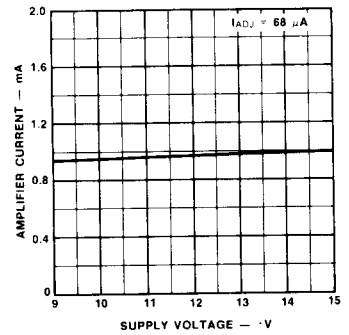

Differential Voltage Gain vs Supply Voltage

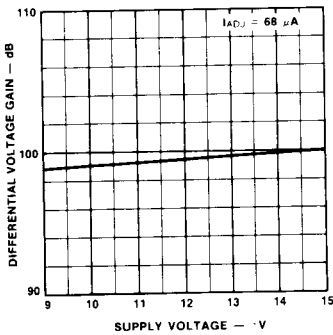

Required R_{ADJ} for Constant I_{ADJ} vs Supply Voltage

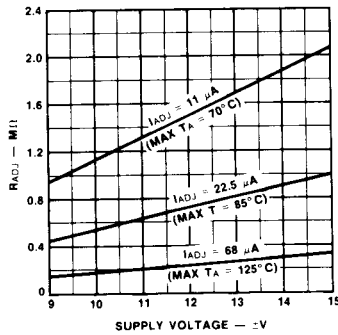

Open Loop Frequency Response for Various Values of Compensation

