

POWER MOS 7® IGBT

The POWER MOS 7® IGBT is a new generation of high voltage power IGBTs. Using Punch Through Technology this IGBT is ideal for many high frequency, high voltage switching applications and has been optimized for high frequency switchmode power supplies.

- Low Conduction Loss
- Low Gate Charge
- Ultrafast Tail Current shutoff
- 100 kHz operation @ 400V, 19A
- 200 kHz operation @ 400V, 12A
- SSOA rated

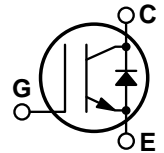
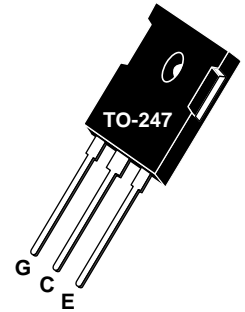

MAXIMUM RATINGS

All Ratings: $T_C = 25^\circ\text{C}$ unless otherwise specified.

| Symbol | Parameter | APT15GP60BDF1 | UNIT |
|----------------|--|---------------|------------------|
| V_{CES} | Collector-Emitter Voltage | 600 | Volts |
| V_{GE} | Gate-Emitter Voltage | ± 20 | |
| V_{GEM} | Gate-Emitter Voltage Transient | ± 30 | |
| I_{C1} | Continuous Collector Current @ $T_C = 25^\circ\text{C}$ | 56 | Amps |
| I_{C2} | Continuous Collector Current @ $T_C = 110^\circ\text{C}$ | 27 | |
| I_{CM} | Pulsed Collector Current ^① @ $T_C = 25^\circ\text{C}$ | 65 | |
| SSOA | Switching Safe Operating Area @ $T_J = 150^\circ\text{C}$ | 65A @ 600V | |
| P_D | Total Power Dissipation | 250 | Watts |
| T_J, T_{STG} | Operating and Storage Junction Temperature Range | -55 to 150 | $^\circ\text{C}$ |
| T_L | Max. Lead Temp. for Soldering: 0.063" from Case for 10 Sec. | 300 | |

STATIC ELECTRICAL CHARACTERISTICS

| Symbol | Characteristic / Test Conditions | MIN | TYP | MAX | UNIT |
|--------------|--|-----|-----|-----------|---------------|
| BV_{CES} | Collector-Emitter Breakdown Voltage ($V_{GE} = 0V, I_C = 500\mu\text{A}$) | 600 | | | Volts |
| $V_{GE(TH)}$ | Gate Threshold Voltage ($V_{CE} = V_{GE}, I_C = 1\text{mA}, T_J = 25^\circ\text{C}$) | 3 | 4.5 | 6 | |
| $V_{CE(ON)}$ | Collector-Emitter On Voltage ($V_{GE} = 15V, I_C = 15A, T_J = 25^\circ\text{C}$) | | 2.2 | 2.7 | |
| | Collector-Emitter On Voltage ($V_{GE} = 15V, I_C = 15A, T_J = 125^\circ\text{C}$) | | 2.1 | | |
| I_{CES} | Collector Cut-off Current ($V_{CE} = 600V, V_{GE} = 0V, T_J = 25^\circ\text{C}$) ^② | | | 500 | μA |
| | Collector Cut-off Current ($V_{CE} = 600V, V_{GE} = 0V, T_J = 125^\circ\text{C}$) ^② | | | 3000 | |
| I_{GES} | Gate-Emitter Leakage Current ($V_{GE} = \pm 20V$) | | | ± 100 | nA |

 **CAUTION:** These Devices are Sensitive to Electrostatic Discharge. Proper Handling Procedures Should Be Followed.

DYNAMIC CHARACTERISTICS

APT15GP60BDF1

| Symbol | Characteristic | Test Conditions | MIN | TYP | MAX | UNIT | |
|--------------|---|---|---|------|-----|------|----|
| C_{ies} | Input Capacitance | Capacitance $V_{GE} = 0V, V_{CE} = 25V$ $f = 1 \text{ MHz}$ | | 1685 | | pF | |
| C_{oes} | Output Capacitance | | | 210 | | | |
| C_{res} | Reverse Transfer Capacitance | | | 15 | | | |
| V_{GEP} | Gate-to-Emitter Plateau Voltage | Gate Charge $V_{GE} = 15V$ $V_{CE} = 300V$ $I_C = 15A$ | | 7.5 | | V | |
| Q_g | Total Gate Charge ^③ | | | 55 | | nC | |
| Q_{ge} | Gate-Emitter Charge | | | 12 | | | |
| Q_{gc} | Gate-Collector ("Miller") Charge | | | 15 | | | |
| SSOA | Switching Safe Operating Area | $T_J = 150^\circ\text{C}, R_G = 5\Omega, V_{GE} = 15V, L = 100\mu\text{H}, V_{CE} = 600V$ | 65 | | | A | |
| $t_{d(on)}$ | Turn-on Delay Time | Inductive Switching (25°C) $V_{CC} = 400V$ $V_{GE} = 15V$ $I_C = 15A$ $R_G = 5\Omega$ $T_J = +25^\circ\text{C}$ | | 8 | | ns | |
| t_r | Current Rise Time | | | 12 | | | |
| $t_{d(off)}$ | Turn-off Delay Time | | | 29 | | | |
| t_f | Current Fall Time | | | 58 | | | |
| E_{on1} | Turn-on Switching Energy ^④ | | | | 130 | | μJ |
| E_{on2} | Turn-on Switching Energy (Diode) ^⑤ | | | | 152 | | |
| E_{off} | Turn-off Switching Energy ^⑥ | | | | 121 | | |
| $t_{d(on)}$ | Turn-on Delay Time | | Inductive Switching (125°C) $V_{CC} = 400V$ $V_{GE} = 15V$ $I_C = 15A$ $R_G = 5\Omega$ $T_J = +125^\circ\text{C}$ | | 8 | | ns |
| t_r | Current Rise Time | | | 12 | | | |
| $t_{d(off)}$ | Turn-off Delay Time | | | 69 | | | |
| t_f | Current Fall Time | | | 88 | | | |
| E_{on1} | Turn-on Switching Energy ^④ | | | | 130 | | μJ |
| E_{on2} | Turn-on Switching Energy (Diode) ^⑤ | | | | 267 | | |
| E_{off} | Turn-off Switching Energy ^⑥ | | | | 268 | | |

THERMAL AND MECHANICAL CHARACTERISTICS

| Symbol | Characteristic | MIN | TYP | MAX | UNIT |
|-----------------|--------------------------|-----|-----|------|------|
| $R_{\theta JC}$ | Junction to Case (IGBT) | | | .50 | °C/W |
| $R_{\theta JC}$ | Junction to Case (DIODE) | | | 1.31 | |
| W_T | Package Weight | | | 5.90 | gm |

- ① Repetitive Rating: Pulse width limited by maximum junction temperature.
- ② For Combi devices, I_{ces} includes both IGBT and FRED leakages
- ③ See MIL-STD-750 Method 3471.
- ④ E_{on1} is the clamped inductive turn-on-energy of the IGBT only, without the effect of a commutating diode reverse recovery current adding to the IGBT turn-on loss. (See Figure 24.)
- ⑤ E_{on2} is the clamped inductive turn-on energy that includes a commutating diode reverse recovery current in the IGBT turn-on switching loss. A Combi device is used for the clamping diode as shown in the E_{on2} test circuit. (See Figures 21, 22.)
- ⑥ E_{off} is the clamped inductive turn-off energy measured in accordance with JEDEC standard JESD24-1. (See Figures 21, 23.)

APT Reserves the right to change, without notice, the specifications and information contained herein.

TYPICAL PERFORMANCE CURVES

APT15GP60BDF1

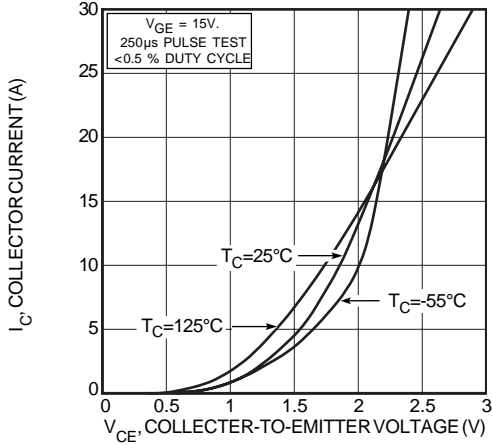

FIGURE 1, Output Characteristics ($V_{GE} = 15V$)

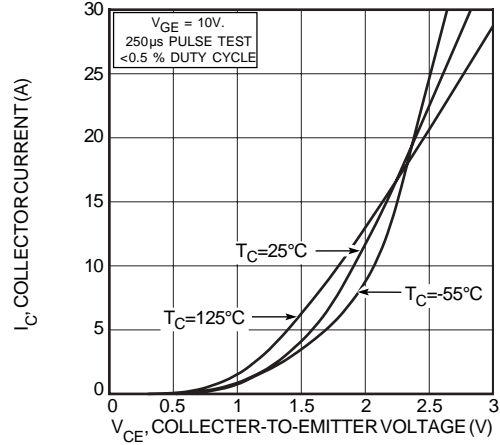

FIGURE 2, Output Characteristics ($V_{GE} = 10V$)

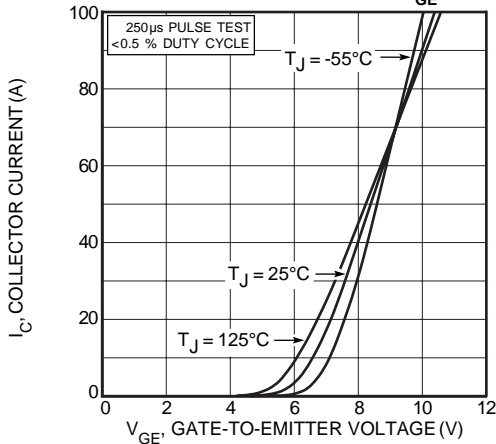

FIGURE 3, Transfer Characteristics

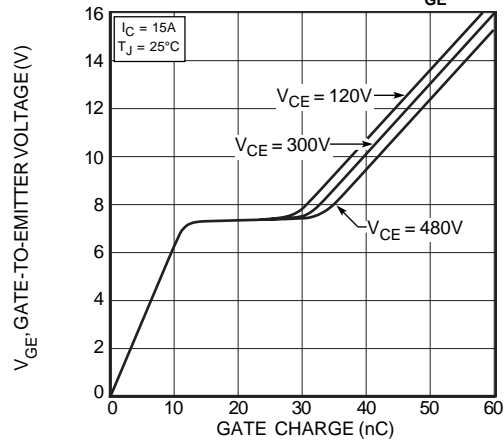

FIGURE 4, Gate Charge

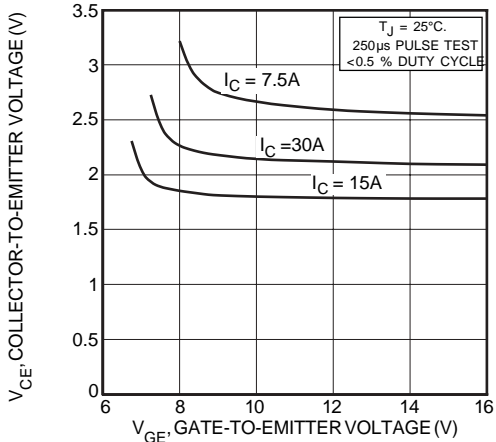

FIGURE 5, On State Voltage vs Gate-to-Emitter Voltage

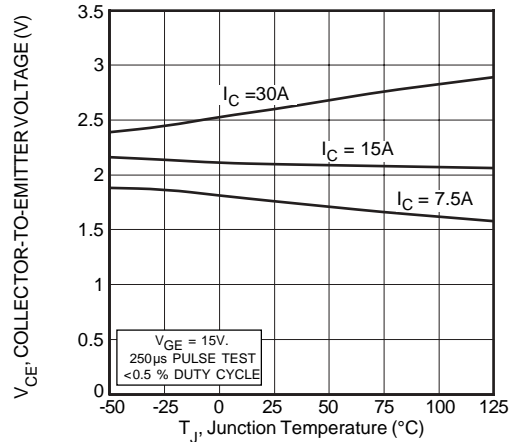

FIGURE 6, On State Voltage vs Junction Temperature

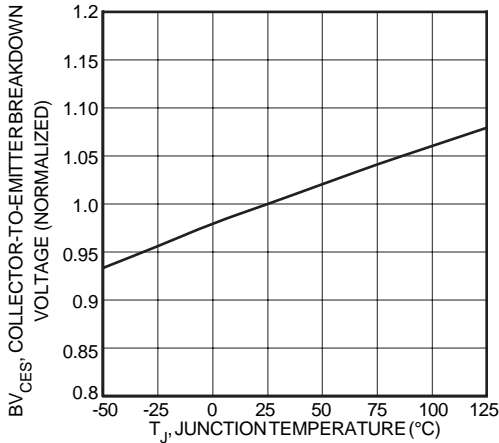

FIGURE 7, Breakdown Voltage vs. Junction Temperature

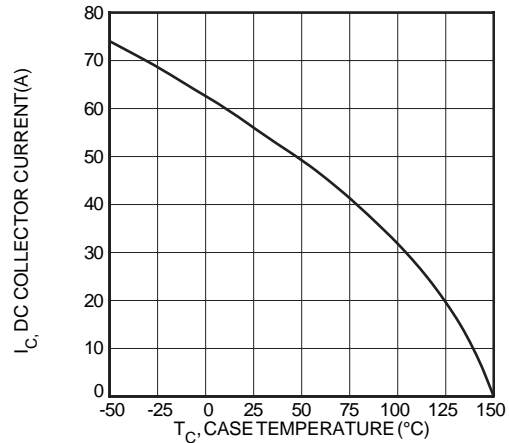

FIGURE 8, DC Collector Current vs Case Temperature

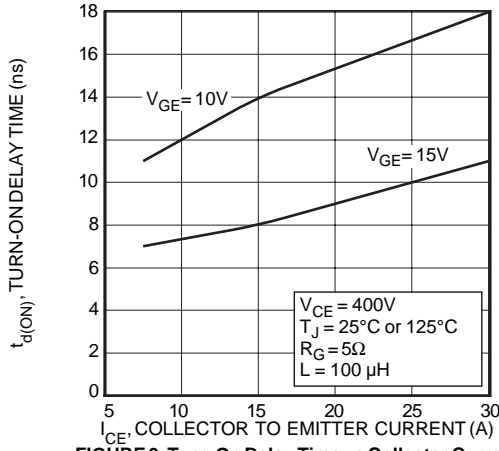

FIGURE 9, Turn-On Delay Time vs Collector Current

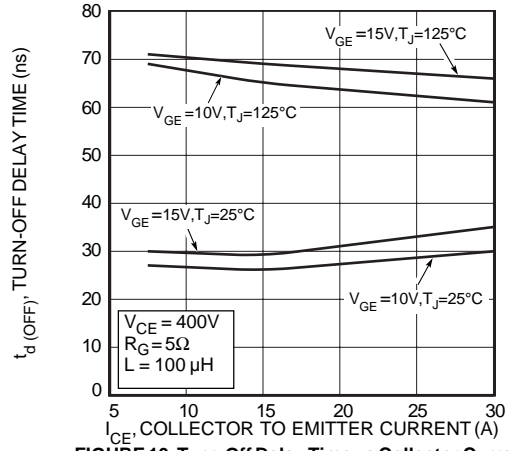

FIGURE 10, Turn-Off Delay Time vs Collector Current

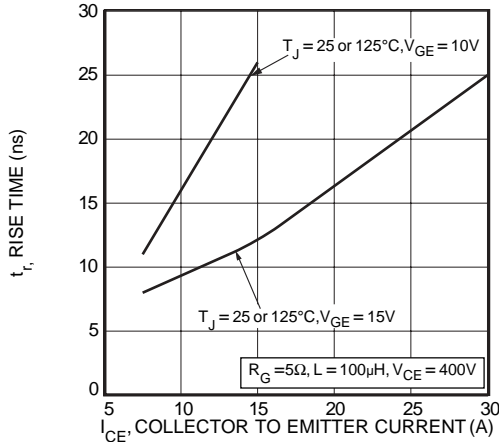

FIGURE 11, Current Rise Time vs Collector Current

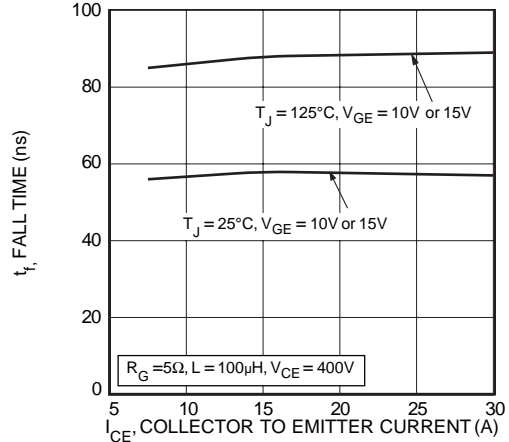

FIGURE 12, Current Fall Time vs Collector Current

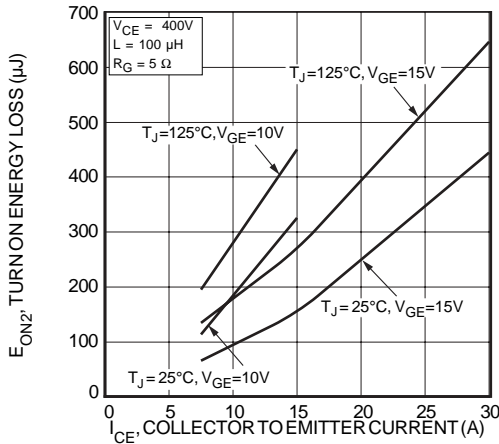

FIGURE 13, Turn-On Energy Loss vs Collector Current

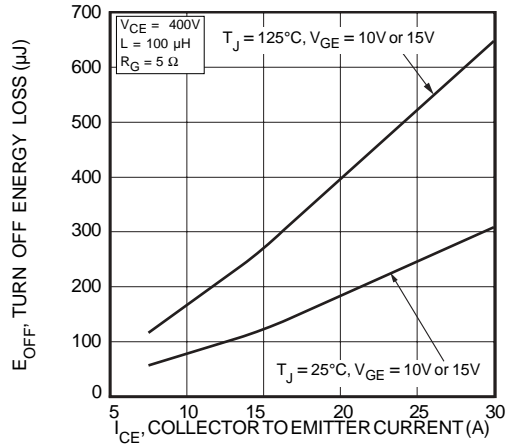

FIGURE 14, Turn Off Energy Loss vs Collector Current

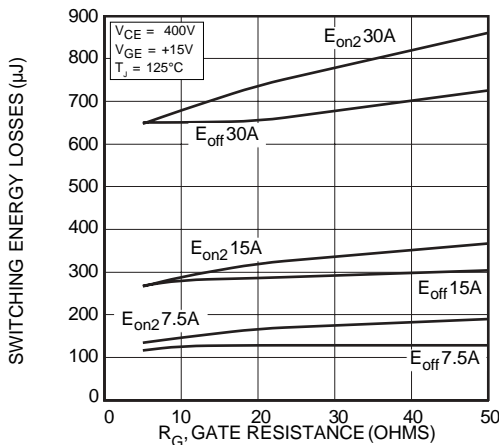

FIGURE 15, Switching Energy Losses vs. Gate Resistance

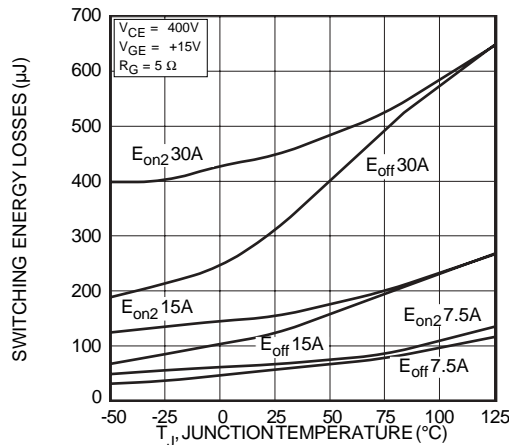

FIGURE 16, Switching Energy Losses vs Junction Temperature

TYPICAL PERFORMANCE CURVES

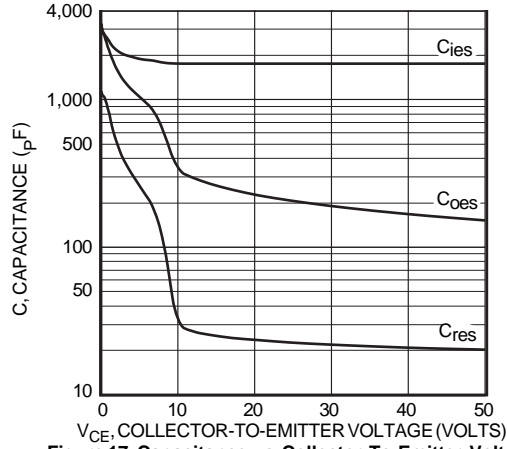

Figure 17, Capacitance vs Collector-To-Emitter Voltage

APT15GP60BDF1

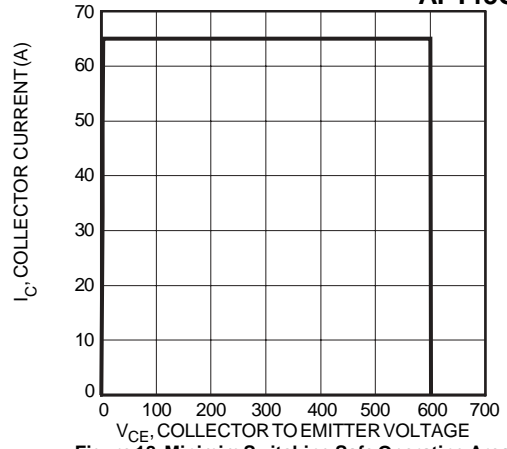

Figure 18, Minimum Switching Safe Operating Area

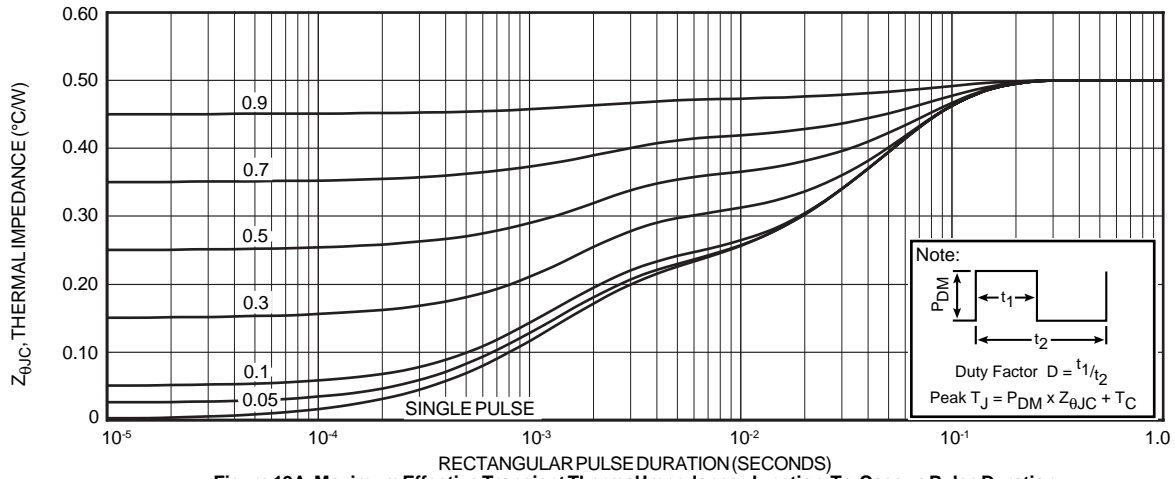

Figure 19A, Maximum Effective Transient Thermal Impedance, Junction-To-Case vs Pulse Duration

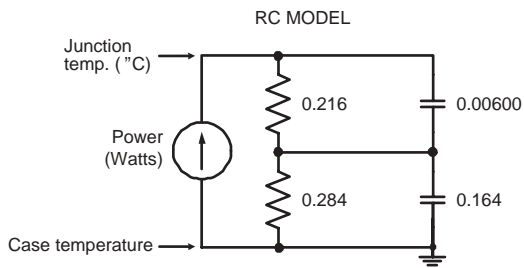

FIGURE 19B, TRANSIENT THERMAL IMPEDANCE MODEL

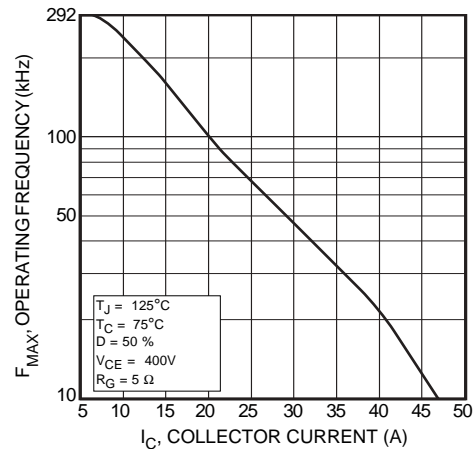

Figure 20, Operating Frequency vs Collector Current

$$F_{max} = \min(f_{max1}, f_{max2})$$

$$f_{max1} = \frac{0.05}{t_{d(on)} + t_r + t_{d(off)} + t_f}$$

$$f_{max2} = \frac{P_{diss} - P_{cond}}{E_{on2} + E_{off}}$$

$$P_{diss} = \frac{T_J - T_C}{R_{\theta JC}}$$

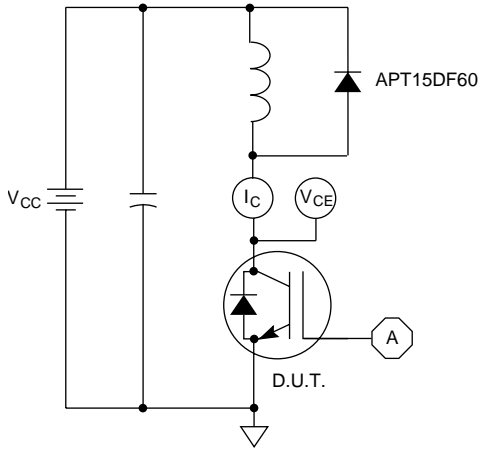

Figure 21, Inductive Switching Test Circuit

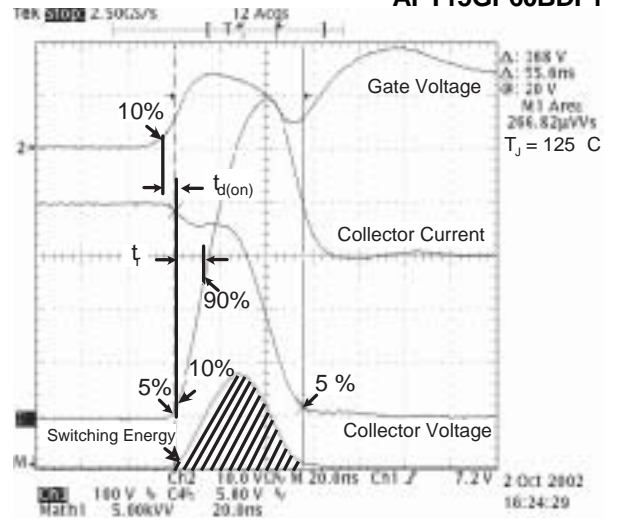

Figure 22, Turn-on Switching Waveforms and Definitions

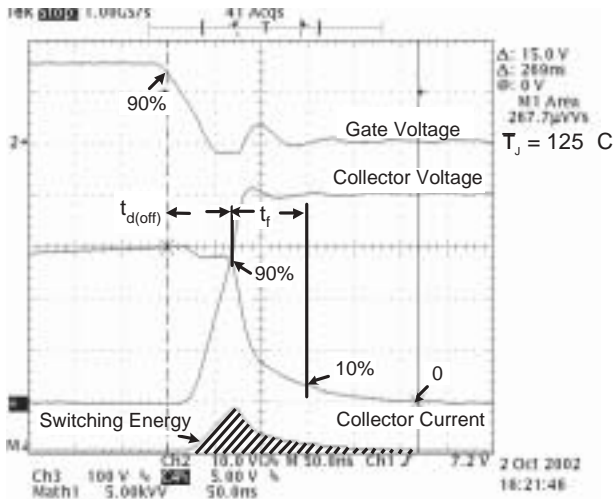

Figure 23, Turn-off Switching Waveforms and Definitions

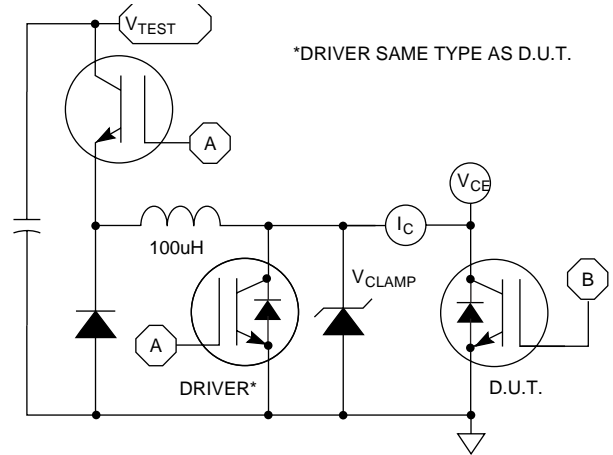

Figure 24, EON1 Test Circuit

ULTRAFAST SOFT RECOVERY ANTI-PARALLEL DIODE

MAXIMUM RATINGS

All Ratings: $T_C = 25^\circ\text{C}$ unless otherwise specified.

| Symbol | Characteristic / Test Conditions | APT15GP60BDF1 | | UNIT |
|------------|--|---------------|--|------|
| $I_F(AV)$ | Maximum Average Forward Current ($T_C = 94^\circ\text{C}$, Duty Cycle = 0.5) | 15 | | Amps |
| $I_F(RMS)$ | RMS Forward Current | 36 | | |
| I_{FSM} | Non-Repetitive Forward Surge Current ($T_J = 45^\circ\text{C}$, 8.3ms) | 110 | | |

STATIC ELECTRICAL CHARACTERISTICS

| Symbol | Characteristic / Test Conditions | MIN | TYP | MAX | UNIT |
|--------|----------------------------------|-----|---|-----|-------|
| V_F | Forward Voltage | | $I_F = 15\text{A}$ | 2.2 | Volts |
| | | | $I_F = 30\text{A}$ | 2.7 | |
| | | | $I_F = 15\text{A}, T_J = 150^\circ\text{C}$ | 1.6 | |

DYNAMIC CHARACTERISTICS

| Symbol | Characteristic | | MIN | TYP | MAX | UNIT |
|------------|---|---------------------------|-----|-----|-----|-------|
| t_{rr1} | Reverse Recovery Time | $T_J = 25^\circ\text{C}$ | | 56 | | ns |
| t_{rr2} | $I_F = 15\text{A}, di_F/dt = -200\text{A}/\mu\text{s}, V_R = 400\text{V}$ | $T_J = 100^\circ\text{C}$ | | 58 | | |
| t_{fr1} | Forward Recovery Time | $T_J = 25^\circ\text{C}$ | | 106 | | ns |
| t_{fr2} | $I_F = 15\text{A}, di_F/dt = 200\text{A}/\mu\text{s}, V_R = 400\text{V}$ | $T_J = 100^\circ\text{C}$ | | 106 | | |
| I_{RRM1} | Maximum Reverse Recovery Current | $T_J = 25^\circ\text{C}$ | | 2.3 | | Amps |
| I_{RRM2} | $I_F = 15\text{A}, di_F/dt = -200\text{A}/\mu\text{s}, V_R = 400\text{V}$ | $T_J = 100^\circ\text{C}$ | | 6 | | |
| Q_{rr1} | Reverse Recovery Charge | $T_J = 25^\circ\text{C}$ | | 77 | | nC |
| Q_{rr2} | $I_F = 15\text{A}, di_F/dt = -200\text{A}/\mu\text{s}, V_R = 400\text{V}$ | $T_J = 100^\circ\text{C}$ | | 235 | | |
| V_{fr1} | Forward Recovery Voltage | $T_J = 25^\circ\text{C}$ | | 5 | | Volts |
| V_{fr2} | $I_F = 15\text{A}, di_F/dt = 200\text{A}/\mu\text{s}, V_R = 400\text{V}$ | $T_J = 100^\circ\text{C}$ | | 5 | | |

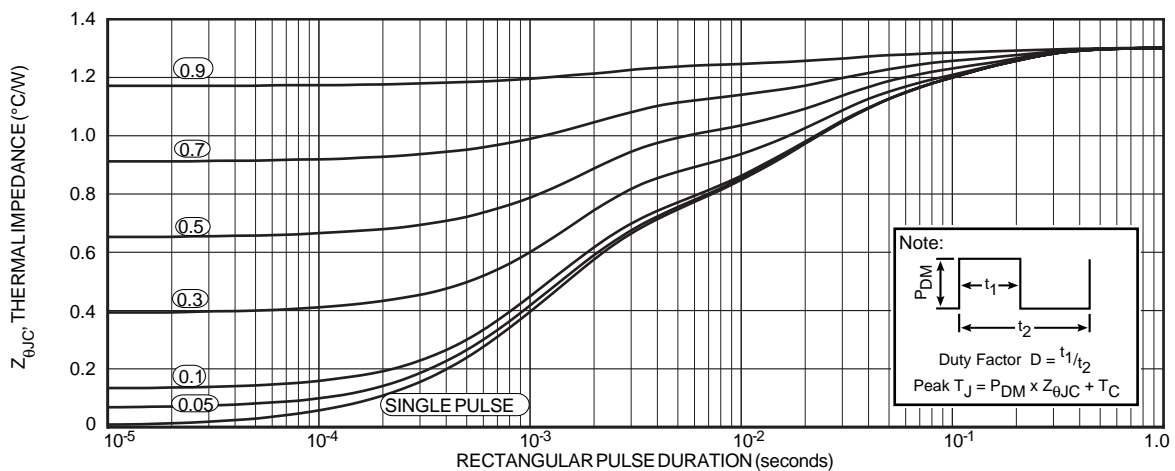

FIGURE 25. MAXIMUM EFFECTIVE TRANSIENT THERMAL IMPEDANCE, JUNCTION-TO-CASE vs PULSE DURATION

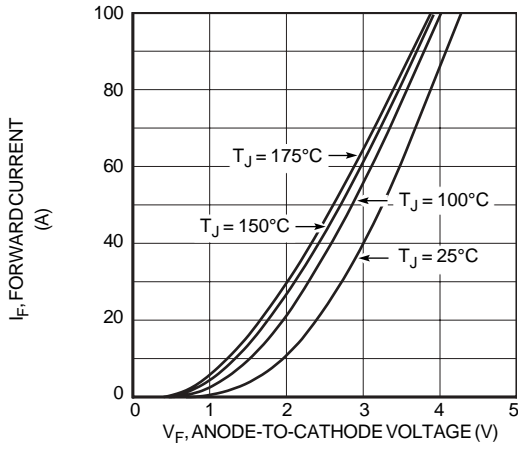

Figure 26, Forward Voltage vs. Forward Current

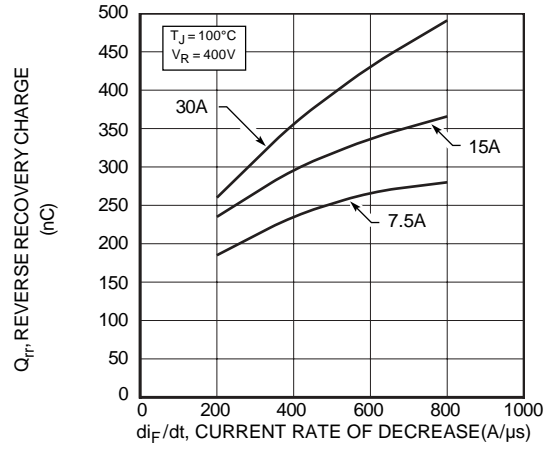

Figure 27, Reverse Recovery Charge vs. Current Rate of Decrease

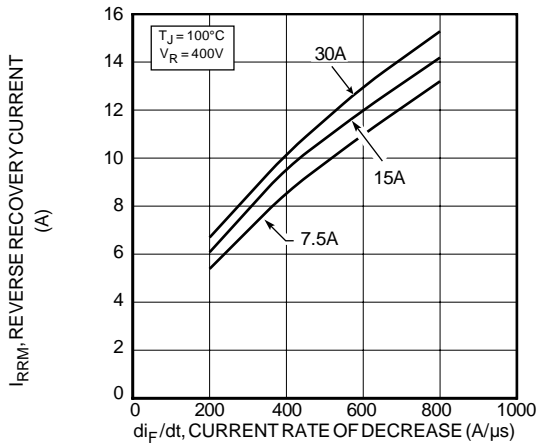

Figure 28, Reverse Recovery Current vs. Current Rate of Decrease

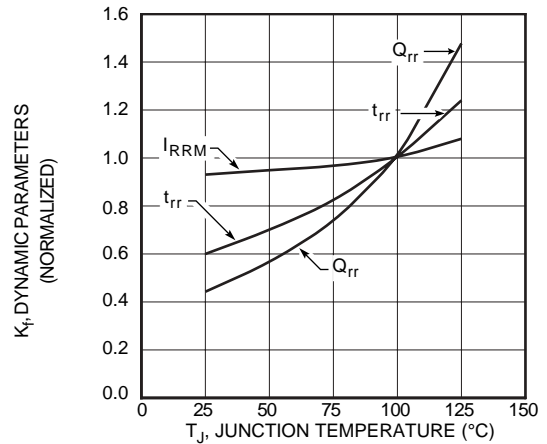

Figure 29, Dynamic Parameters vs. Junction Temperature

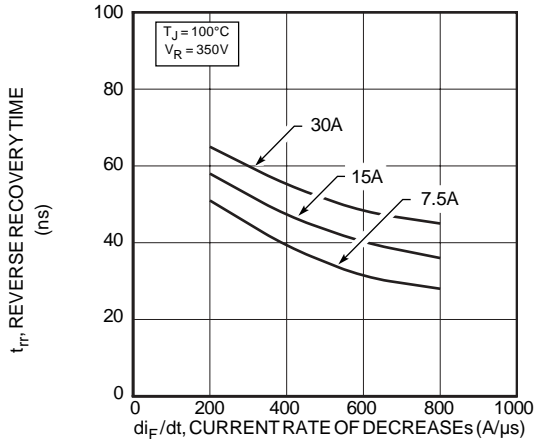

Figure 30, Reverse Recovery Time vs. Current Rate of Decrease

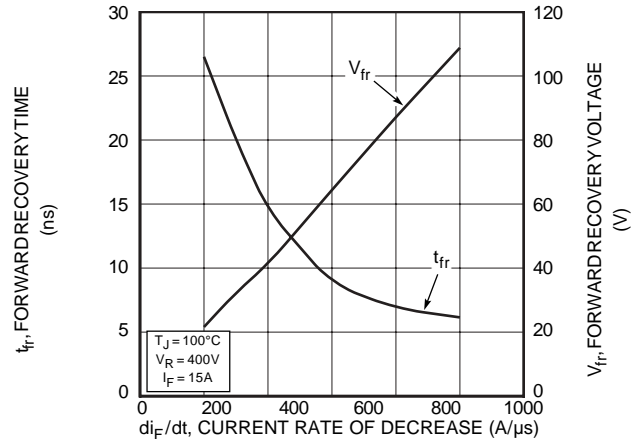

Figure 31, Forward Recovery Voltage/Time vs. Current Rate of Decrease

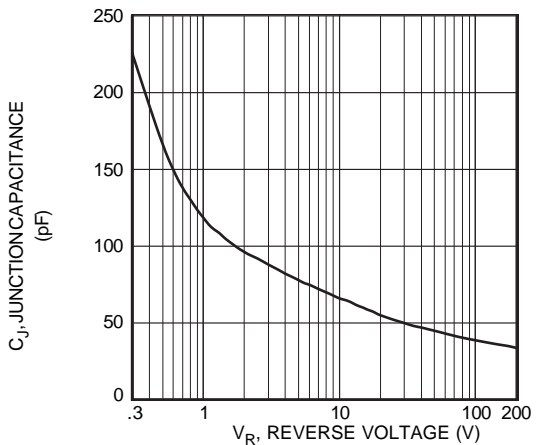

Figure 32, Junction Capacitance vs. Reverse Voltage

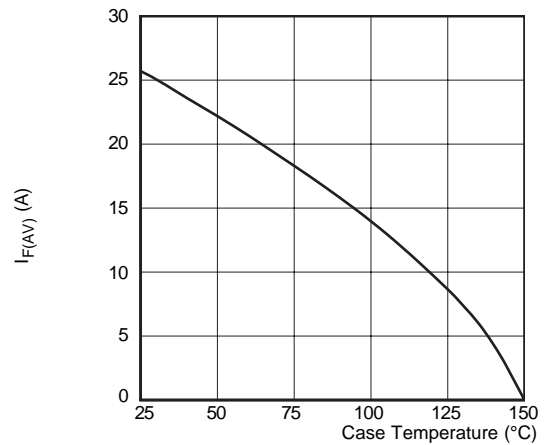

Figure 33, Maximum Average Forward Current vs. Case Temperature

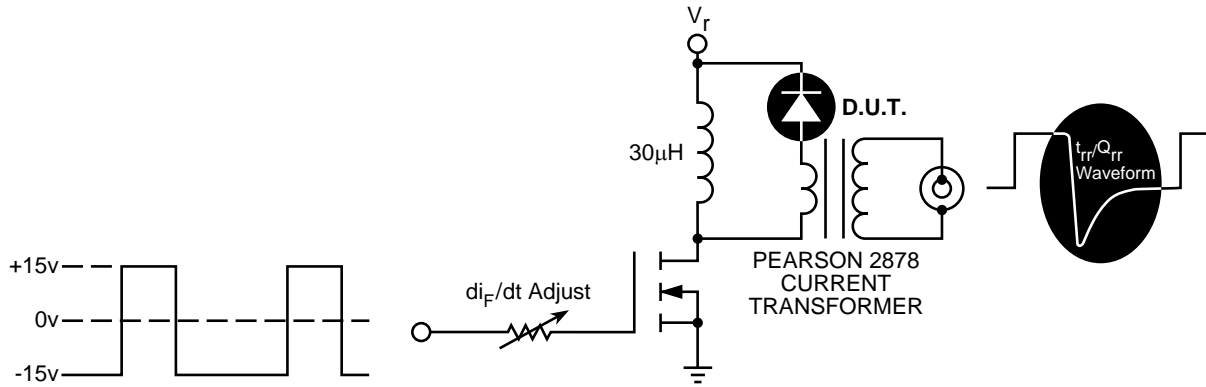

Figure 10. Diode Reverse Recovery Test Circuit and Waveforms

- 1 I_F - Forward Conduction Current
- 2 di_F/dt - Current Rate of Decrease, Rate of Diode Current Change Through Zero Crossing From Positive to Negative.
- 3 I_{RRM} - Maximum Reverse Recovery Current.
- 4 t_{rr} - Reverse Recovery Time, measured from zero crossing where diode current goes from positive to negative, to the point at which the straight line through I_{RRM} and $0.25 \cdot I_{RRM}$ passes through zero.
- 5 Q_{rr} - Area Under the Curve Defined by I_{RRM} and t_{rr} .
- 6 di_M/dt - Maximum Rate of Current Increase During the Trailing Portion of t_{rr} .

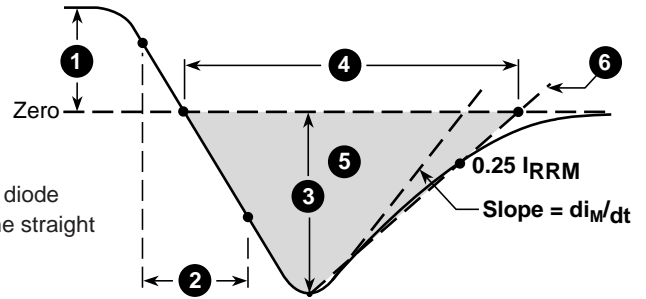
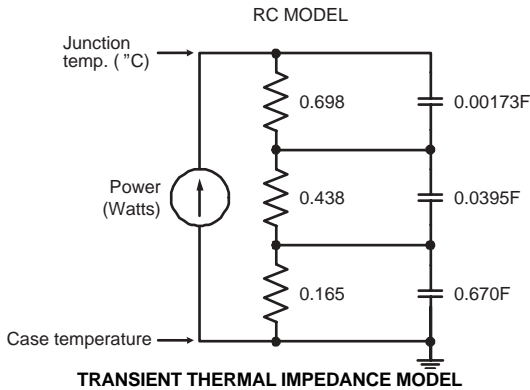
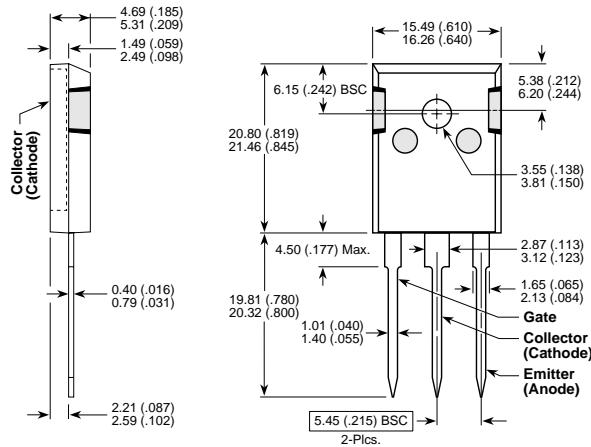

Figure 34. Diode Reverse Recovery Waveform and Definitions



T0-247 Package Outline



Dimensions in Millimeters and (Inches)
 APT's products are covered by one or more of U.S. patents 4,895,810 5,045,903 5,089,434 5,182,234 5,019,522
 5,262,336 6,503,786 5,256,583 4,748,103 5,283,202 5,231,474 5,434,095 5,528,058 and foreign patents. US and Foreign patents pending. All Rights Reserved.