

# TH 7883A

## FULL FIELD CCD IMAGE SENSOR 576 × 384 PIXELS

- Image zone : 13.25 × 8.83 mm.
- Dark reference for each line.
- Square pixels (23 μm × 23 μm) with 100 % aperture.
- Optimized resolution and responsivity in the 400-1100 nm spectrum (visible + near infrared):  
30 db S/N at 30 milli-lux,  
60 % modulation at nyquist frequency.
- 4-phase operation (dynamic range : 13000/1).
- Minimum readout time : 17 ms (for entire field).

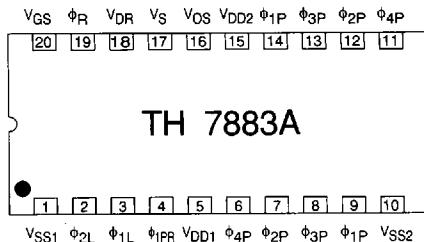

### OPTIONS

- Fiber optic window 1:1.
- UV coating for improved sensitivity in UV and blue.
- Non sealed window.

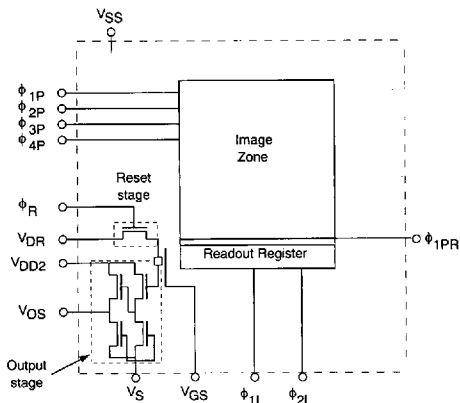

Figure 1 : TH 7883A organization.

### PIN IDENTIFICATION

Pin n°	Symbol	Designation
14, 12, 13, 11 9, 7, 8, 6	$\phi_{1P} \rightarrow \phi_{4P}$	Image zone clocks
4	$\phi_{1PR}$	Image-to-register gate clock
3, 2	$\phi_{L1}, \phi_{2L}$	Readout register clocks
19	$\phi_R$	Reset clock
5, 15	VDD1, VDD2	Output amplifier drain supply
18	VDR	Reset bias
1, 10	VSS1, VSS2	Substrate bias
20	VGS	Register output gate bias
16	VOS	Video output signal
17	VS	Output amplifier source bias

**GEOMETRICAL CHARACTERISTICS**

Photoelement pitch (see Figure 2):  $23\ \mu\text{m} \times 23\ \mu\text{m}$ .

Elementary photosensitive area:  $23\ \mu\text{m} \times 23\ \mu\text{m}$ .

Image zone dimensions:  $13.248\ \text{mm (V)} \times 8.832\ \text{mm (H)}$ .

The image is made up of a single field of 576 lines plus 4 extra lines. The video line is composed of 384 useful pixels, and 407 elements in total (see timing diagram, Figure 5).

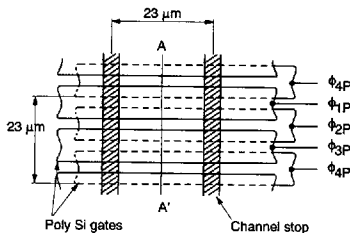

Figure 2a: Front view of a photoelement.

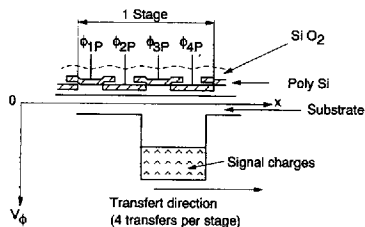

Figure 2b: Cross-sectional view (AA') of a photoelement and potential profile during transfer.

**ABSOLUTE MAXIMUM RATINGS**

Storage temperature	-55°C to +150°C
Operating temperature	-40°C to +85°C
Maximum applied voltages:	
- pins: 1, 10, 17	0 V (ground)
- pins: 5, 15, 18	-0.3 V to +18 V
- pins: 2, 3, 4, 6, 7, 8, 9, 11, 12, 13, 14, 19, 20	-0.3 V to +16 V
Thermal cycling	15°C/mn

Stresses above those listed under ABSOLUTE MAXIMUM RATINGS may cause permanent device failure. Functionality at or above these limits is not implied. Exposure to absolute maximum ratings for extended periods may affect device reliability.

**OPERATING RANGE**

Operating range defines the limits between which the functionality is guaranteed.

Electrical limits of applied signals are given in operating conditions section.

Thermal limits are given in each image grade specification.

**OPERATING PRECAUTIONS**

Shorting the video output to  $V_{SS}$  or  $V_{DD}$ , even temporarily, can permanently damage the output amplifier.

**OPERATING CONDITIONS (T = 25°C)**

Table 1 - DC characteristics

Parameter	Symbol	Value			Unit
		Min	Typ	Max	
Output amplifier drain supply	$V_{DD1} - V_{DD2}$	14.5	15.0	15.5	V
Reset bias	$V_{DR}$	$V_{DD} - 2.4$	$V_{DD} - 2.2$	$V_{DD} - 2$	V
Substrate bias (Note 1)	$V_{SS1} - V_{SS2}$		0.0		V
Output amplifier source bias (Note 2)	$V_S$		0.0		V
Register output gate bias	$V_{GS}$	1.3	1.5	1.7	V

**Note 1:**  $V_{SS} = 0\ \text{V}$  requires that the drive clocks, loaded by the device, do not contain spurious negative spikes (less than  $-0.1\ \text{V}$ ).

**Note 2:** A separate bias on  $V_S$  pin provides a better output signal regarding spurious spikes.

**TIMING DIAGRAM**

The principle of interlacing shown in Figure 7, can be applied to this device. It consists in shifting the potential wells by half a pixel in alternate fields. Thus two successive fields contain different information, giving a 1152-line image with reduced aliasing.

Device operation generally begins with a «cleaning» period, which consists in transferring and eliminating all charges created by thermal generation. Once emptied, each pixel can accumulate charges in proportion to incident light during the integration (exposure) period.

After that time, no luminous event must reach the image zone, in order to prevent smearing effects during the image readout period. This condition can be achieved by using a shutter, gated intensifier or strobe (as an example) to ensure that no light is collected during the readout period. The 580 lines are then transferred, line by line, into the output register. The total number of transfer periods is at least 580.

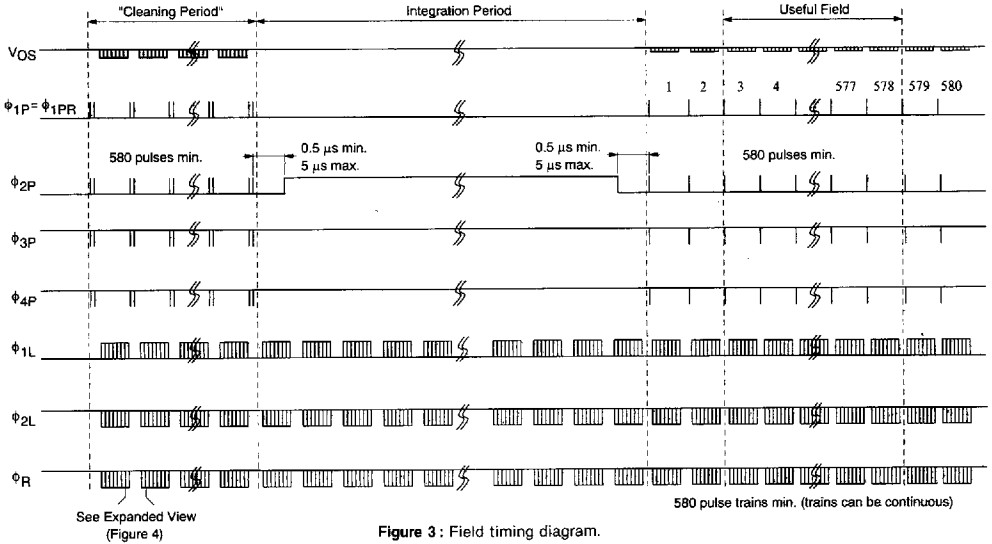

Figure 3: Field timing diagram.

4

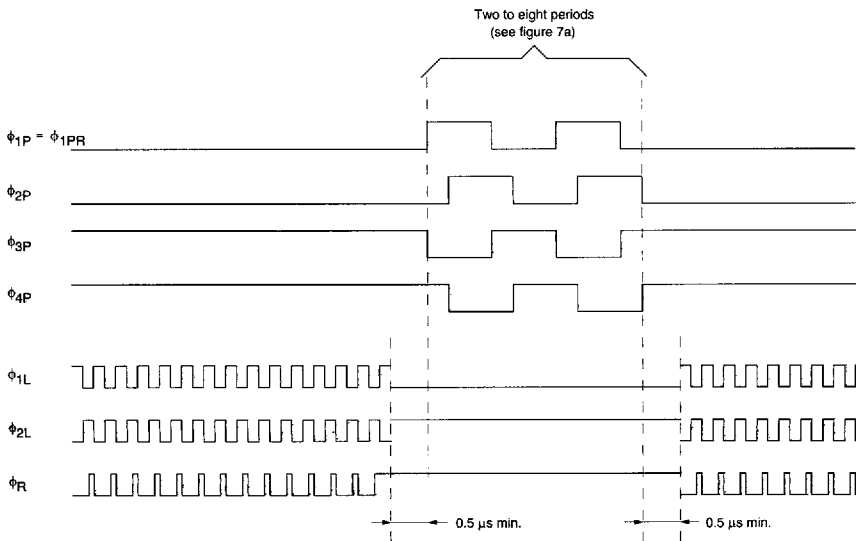

Figure 4: Expanded view.

After parallel transfer into the readout register, the video line is transferred sequentially to a single output circuit. The minimum number of drive clock pulses (407) corresponds to the number of register stages.

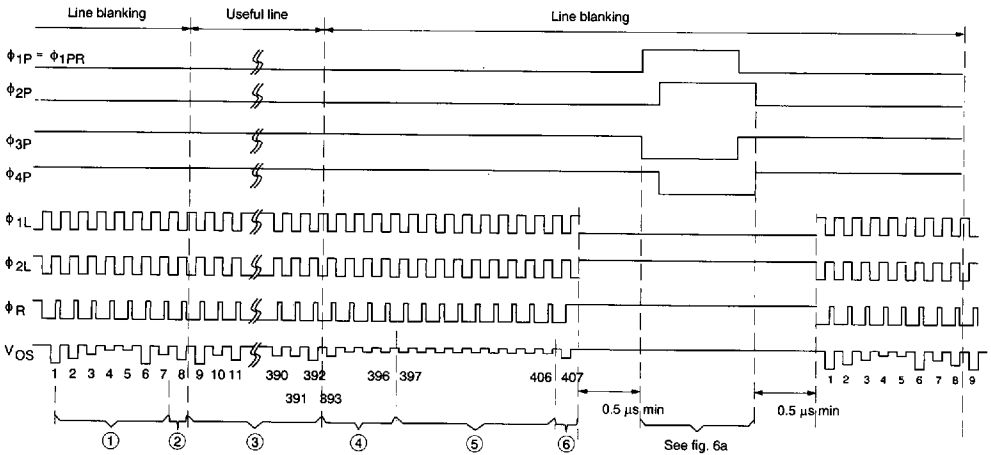
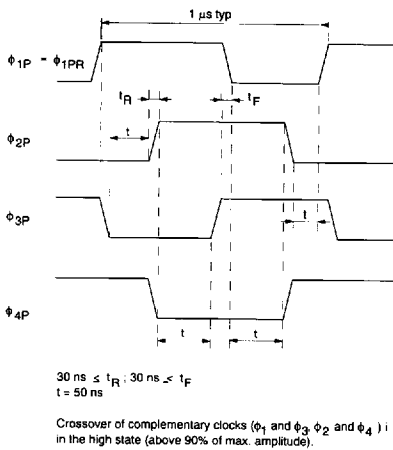

Figure 5: Line timing diagram.

The video line comprises:

- 1 - 7 inactive "pre-scan" elements = zero reference level
- 2 - 1 isolation element;
- 3 - 384 useful video pixels;
- 4 - 4 isolation elements;
- 5 - 10 dark reference elements (element 397 to 406);
- 6 - 1 isolation element;

All 23 dummy elements are read during the line blanking period



$30 \text{ ns} \leq t_R, 30 \text{ ns} \leq t_F$   
 $t = 50 \text{ ns}$

Crossover of complementary clocks ( $\phi_1$  and  $\phi_3$ ,  $\phi_2$  and  $\phi_4$ ) in the high state (above 90% of max. amplitude).

Figure 6a: Output timing diagram for  $\phi_P$  clocks during transfer.

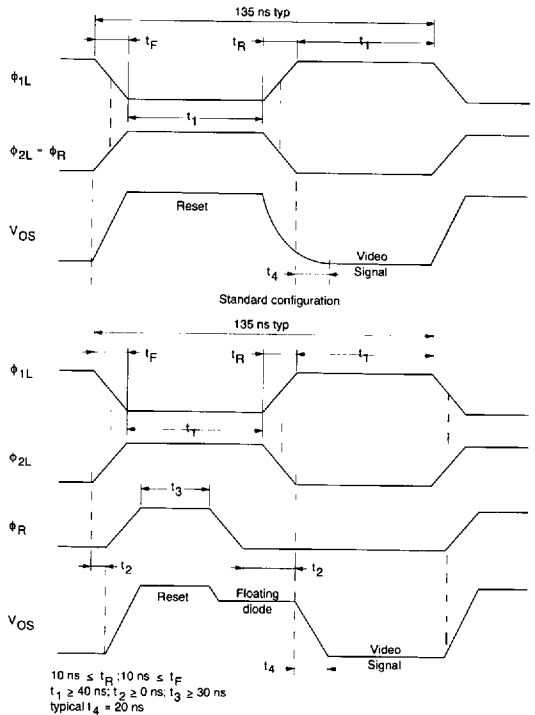

$10 \text{ ns} \leq t_R, 10 \text{ ns} \leq t_F$   
 $t_1 \geq 40 \text{ ns}; t_2 \geq 0 \text{ ns}; t_3 \geq 30 \text{ ns}$   
 typical  $t_4 = 20 \text{ ns}$

Crossover of complementary clocks ( $\phi_{1L}$  and  $\phi_{2L}$ ) preferably at 50% of their amplitude

Configuration needed to obtain floating diode for correlated sampling

Figure 6b: Output timing diagram for readout register and reset clocks.

Table 2 - Drive clock characteristics

Parameter	Symbol	Value			Unit	Remarks
		Min	Typ	Max		
Image zone clocks during integration period OR	$\phi_{1P}, \phi_{1PR}, \phi_{2P}$ $\phi_{3P}$ $\phi_{4P}$	9 0.0 1.5	10 0.3 1.8	11 0.5 2.0	V V V	see Note $C\phi_{1P} = C\phi_{2P} = C\phi_{3P} =$ $C\phi_{4P} = 4\ 000\ \text{pF max}$ $C\phi_{1PR} = 20\ \text{pF max}$
	$\phi_{1P}, \phi_{1PR}$ $\phi_{2P}$ $\phi_{3P}, \phi_{4P}$	0.0 1.5 9	0.3 1.8 10	0.5 2.0 11	V V V	
Image zone clocks during transfer period	$(\phi_P)$ Low $(\phi_P)$ High	0.0 9	0.3 10	0.5 11	V V	
Output register and reset clocks : Low (L) High (H)	$(\phi_L, \phi_R)$ L $(\phi_L, \phi_R)$ H	0.0 9	0.3 10	0.5 11	V V	$C\phi_{1L} = C\phi_{2L} = 120\ \text{pF max}$ $C\phi_{R} < 5\ \text{pF}$
<b>Note :</b> Transients under 0.0 V in the clock pulses will lead to charge injection, causing a localized increase in the dark signal. If such spurious negative transients are present, they can be suppressed by inserting a serial resistor of appropriate value (typically 20 to 100 $\Omega$ ) in the corresponding driver output.						

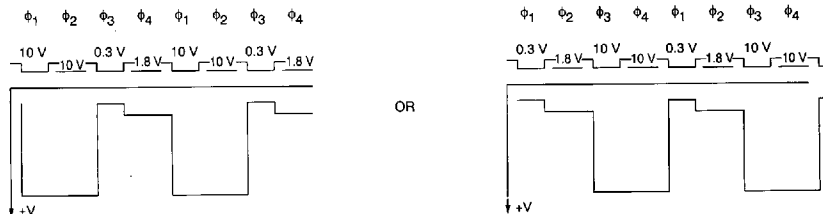

Figure 7 : Image zone potential wells during integration period.

Table 3 - Static and dynamic electrical characteristics

Parameter	Symbol	Value			Unit	Conditions
		Min	Typ	Max		
DC output level	$V_{ref}$		12		V	
Output impedance	$Z_S$		250		$\Omega$	
Maximum image to output register frequency	$F_I$ max	0.9	1.8		MHz	see Note
Maximum output register and reset frequency	$F_L$ max	7.38	12		MHz	see Note
Output amplifier supply current	$I_{DD}$		6	10	mA	$V_{DD} = \phi_R = V_{DR} = 15\ \text{V}$ $V_{SS} = 0\ \text{V}$
Input current on an active pin (except for $V_{DR}$ and $V_{DD}$ )	$I_e$			2	$\mu\text{A}$	$V_e = 15\ \text{V}, V_{SS} = 0\ \text{V}$
Peak current on one clock ( $\phi_P$ )	$I_{pp}\ \phi_P$		600		mA	Under typical operating conditions $t_{rise} = 50\ \text{ns}$
Peak current on one clock ( $\phi_L$ )	$I_{pp}\ \phi_L$		120		mA	Under typical operating conditions $t_{rise} = 10\ \text{ns}$

**Note :** The minimum clock frequency is limited by the increase in dark signal.

**ELECTROOPTICAL PERFORMANCE**

- General measurement conditions :  $T_c = 25^\circ\text{C}$ 
  - Integration time : 20 ms,
  - Output frequency : 7.38 MHz.
- Illumination conditions
  - 2854 K tungsten filament lamp + 2 mm BG 38 filter + F/3.5 aperture. The filter limits the spectrum to 700 nm ; in these conditions,  $1 \mu\text{J}/\text{cm}^2$  corresponds to 3.5 lux.s.
- Typical operating conditions (see Tables 1 and 2).
- Measurement excludes ;
  - first and last pixels of useful video line (n° 9 and 392),
  - first and last lines of useful field (n° 3 and 578),
  - dummy elements,
  - blemishes.

**Table 4 - Performance characteristics**

Parameter	Symbol	Value			Unit	Remarks
		Min	Typ	Max		
Saturation output voltage	VSAT	0.9	2.0		V	Note 1
Saturation exposure	ESAT		0.18		$\mu\text{J}/\text{cm}^2$	
Responsivity	R	7	11		$\text{V}/\mu\text{J}/\text{cm}^2$	See Figure 8
Photo-response non-uniformity, $\sigma$	PRNU		$\pm 1$	$\pm 3$	% V <sub>OS</sub>	Notes 2 and 3
Noise in darkness (rms)	V <sub>N</sub>		0.15		mV	Note 4
Dynamic range (relative to rms noise)	D <sub>R</sub>		13000			
Average dark signal	V <sub>DS</sub>		2	8	mV	Note 5
Dark signal non-uniformity, $\sigma$	DSNU		0.2	0.7	mV	Notes 3 and 6

**Note 1 :** 1 mV = 470 electrons or 0.45 nA, VSAT min is a guaranteed voltage level above which local saturation or non linearity can occur.

**Note 2 :** From low level (limited by DSNU) up to 90 % VSAT min.

**Note 3 :** Number of blemishes allowed ; see image grade specification.

**Note 4 :** Measured with Correlated Double Sampling (CDS).

**Note 5 :** Measured with respect to zero reference level.

**Note 6 :** Measured with line clamping on dark reference.



9026872 0002165 786

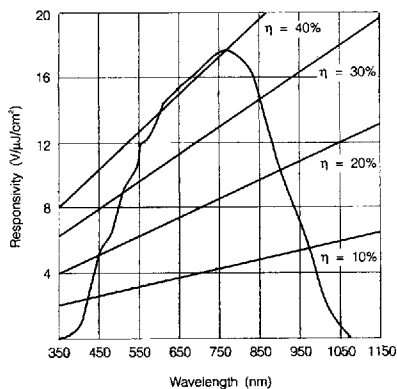
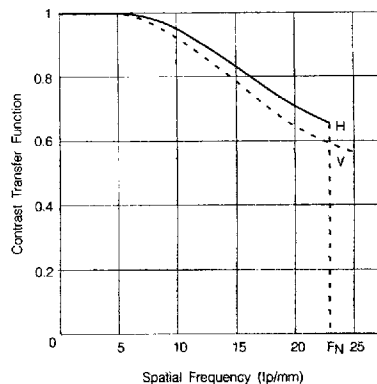

Figure 8: Typical spectral response.

Figure 9: Typical CTF curves ( $\overline{VOS} = 400$  mV).

#### ELECTROOPTICAL PERFORMANCE WITHOUT INFRARED CUTOFF FILTER

The TH 7883A's special semiconductor process enables it to exploit the silicon's high near infrared sensitivity while maintaining good imaging performance in terms of response uniformity and resolution. Changes in performance with and without IR filtering are summarized below.

Table 5 - Electrooptical performance comparison

	With IR cutoff filter	No IR cutoff filter
Average video signal due to a given scene illumination	VOS	VOS × 8
Photo response non-uniformity	± 1 %	± 1 %
CTF at nyquist frequency	60 %	40 %

4

## IMAGE QUALITY GRADE

**GRADE H** : ordering code TH78883AVCH.

This image quality grade is guaranteed at +25°C and +85°C for applications with a wide operating range (-40°C to +85°C).

## BLEMISH DEFINITION

**Column**

It is a one-pixel wide defect whose height is constant with light level.

**Blemish**

A blemish is a white or black spot. There are usually three types of blemish :

- white defect, dependent on temperature, as dark signal : its amplitude doubles for every 8 to 10°C temperature rise.
- black defect, not dependent on temperature, but whose amplitude is proportional to the mean output voltage.
- trap, a trap appears as a partial back column, which fills in with a constant amount of charge. Thus a trap affects a number of pixels which varies with the mean level of the output signal. The length of the partial column will increase with a reduction in temperature or light level.

White defects are specified in darkness, at +25°C and +85°C for H grade.

Black defects are specified under illumination, as a percentage of mean illumination up to 90 %.  $V_{SAT}$  min independently of temperature.

Traps are specified as defects in darkness, at 25°C.

First and last useful line and first and last useful column are excluded from the image grade.

## IMAGE GRADE SPECIFICATION

**Note** :  $\alpha$  is the amplitude of video signal of blemishes.

Eg : 20 % <  $\alpha$  < 40 %.

For amplitude < 20 %, pixel is not a blemish.

For amplitude > 40 %, the device is rejected.

Depending on temperature and light level, the amplitude  $\alpha$  is the highest value expressed either in % of  $V_{OS}$  or in mV in darkness at operating temperature.

$$V_{OS} \leq 90 \% V_{SAT} \text{ min}$$

$$T_C = -40^\circ\text{C to } +85^\circ\text{C}$$

Type (white or black)	W	B
Maximum number of blemishes	0	20
Amplitude $\alpha$ (%)	$\alpha > 15$	$20 < \alpha < 40$
Area, max (pixels)		1
Maximum number of columns	0	
Amplitude $\alpha$ (%)	$\alpha > 3$	

In darkness  $T_C = +25^\circ\text{C}$

Maximum number of blemishes	0
Amplitude $\alpha$	$\alpha > 2 \text{ mV}$
Maximum number of columns	0
Amplitude $\alpha$	$\alpha > 0.8 \text{ mV}$

In darkness  $T_C = +85^\circ\text{C}$

Maximum number of blemishes	0
Amplitude $\alpha$	$\alpha > 70 \text{ mV}$
Maximum number of columns	0
Amplitude $\alpha$	$\alpha > 35 \text{ mV}$
Average dark signal, max	220 mV
Dark signal non uniformity, max	45 mV





**NON SEALED WINDOW PACKAGE****DESCRIPTION**

The sensor chips are assembled in a standard ceramic DIL package, but the window sealing operation is omitted. The window is simply held in place by adhesive tape or clips to provide mechanical protection of the chip during handling and shipping.

**SHIPPING**

The devices are enclosed in a sealed anti-static bag with a dessicant.

**STORAGE**

The pieces must be stored in a dry, inert atmosphere such as nitrogen or dry air.

**ORDERING CODE**

Open-package sensors are designated by the letter N (5<sup>th</sup> letter of the reference) :  
TH7883AVCHN (image quality grade H).

**TH 7883A WITH FIBER OPTIC WINDOW****DESCRIPTION**

TH 7883A area array CCD image sensor is also available in a special fiber-optic (FO) configuration, in which an FO window is glued to the sensor chip. The FO window is formed of low absorption elementary fibers separated by EMA (extra-mural absorption) cement to minimize crosstalk.

FO window sensors are comprised of the following elements :

- a high image quality grade sensor chip,
- a DIL ceramic package,
- an FO window of geometry adapted to sensor,
- a mechanical support (with grounding wire) to ensure the assembly's rigidity.

TH 7883A is available with a 1:1 optical fiber.

**ORDERING CODE :** TH7883AVCBF.

**ABSOLUTE MAXIMUM RATINGS**

Absolute maximum ratings are the same as for standard TH 7883A, except for :

Storage temperature .....	- 55°C to + 85°C
Thermal cycling .....	10°C/mn
Maximum allowed pressure .....	2 bars

**OPERATING RANGE**

Operating range defines the limits between which the functionality is guaranteed.

Electrical operating range : same as standard TH 7883A.

Thermal limits are given in image grade specification.

**OPERATING PRECAUTIONS**

Shorting the video output to  $V_{SS}$  or  $V_{DD}$ , even temporarily, can permanently damage the output amplifier.

Connect the ground lead before operating the CCD. In case of coupling to a device containing high voltages, such as light image intensifier, the ground connection must be made both before device operation and after the device supply has returned to 0 V.

**OPERATING CONDITIONS**

Same values as standard TH 7883A.



Table 6 - TH7883AVCBF performance characteristics

General measurement conditions : same as standard TH 7883A

Parameter	Symbol	Value			Unit	Conditions
		Min	Typ	Max		
Saturation output voltage	VSAT	0.9	2.0		V	Notes 1 and 2
Saturation exposure	ESAT		0.22		$\mu\text{J}/\text{cm}^2$	
Responsivity	R	5	9		$\text{V}/\mu\text{J}/\text{cm}^2$	Note 3
Photo-response non-uniformity	PRNU		$\pm 5$		% VOS	Note 4
Noise in darkness (rms)	VN		0.15		mV	Notes 1 and 2
Dynamic range (relative to rms noise)	DR		13000			Note 1
Average dark signal	VDS		2	8	mV	Notes 1 and 5
Dark signal non-uniformity ; $\sigma$	DSNU		0.2	0.7	mV	Notes 1 and 6
Numerical aperture			1			
Contrast transfert function	CTF		50		%	At Nyquist frequency

**Note 1 :** Performance is the same as the standard TH 7883A one.**Note 2 :** 1 mV = 470 electrons or 0.45 nA.**Note 3 :** Typically, 80 % of the responsivity of the TH 7883A without Fiber Optic.**Note 4 :** PRNU of the CCD + FO is not a gaussian curve : the fiber adds a certain amount of black blemishes, but no white blemishes.Typically, there is 2% pixels whose amplitude is  $\leq V_{OS} - 10\%$ .

Number of allowed blemishes : see image grade specification.

**Note 5 :** Measured with respect to zero reference level.**Note 6 :** Measured with line clamping on dark reference.

## IMAGE GRADE SPECIFICATION - TH7883AVCBF

Temperature range :  $-40^\circ\text{C}$  to  $+85^\circ\text{C}$ .In darkness  $T_C = +25^\circ\text{C}$ 

Maximum number of blemishes Amplitude $\alpha$	1 $\alpha > 2 \text{ mV}$
Maximum number of columns Amplitude $\alpha$	0 $\alpha > 0.8 \text{ mV}$

 $V_{OS} \leq 90\% V_{SAT \text{ min}}$ 

	White	Black
Maximum number of spots Amplitude $\alpha$ (%) Area, max (pixels) Note 1	0 $\alpha > 15$	30 $\alpha > 20$ 3x3
Maximum number of dashes Amplitude $\alpha$ (%) Length, max (pixels) Note 2	0	10 $10 < \alpha < 20$ 10
Maximum number of columns Amplitude $\alpha$ (%)	0 $\alpha > 3$	
<b>Note 1 :</b> Less of 1% of one pixel size black spots.		
<b>Note 2 :</b> Less than five pixel long dashes are not taken in account. If $\alpha > 20\%$ , the dash is considered as a «Spot» blemish.		

## TH 7883A WITH UV COATING

## DESCRIPTION

UV coating is a proprietary organic phosphor developed in order to improve sensitivity of charge-coupled devices (CCDs) in blue-visible and ultraviolet wavelengths. A 0.4 to 0.6  $\mu\text{m}$  thick UV coating applied to frontside-illuminated CCD dramatically improves the quantum efficiency of the device in the 120 nm to 450 nm range.

Optical properties : UV coating emits light at approximately 540 to 580 nm when excited with light of wavelengths shorter than 450 nm. The conversion efficiency of the coating is nearly unity which makes it an ideal ultraviolet downconverter for use on silicon detectors. At wavelengths longer than 460 nm, UV coating is transparent and, thus, has no detrimental effect on the quantum efficiency of a CCD in the visible and near-infrared portions of the spectrum.

The window of the CCD with UV coating is transparent down to 180 nm (quartz window).

## ORDERING CODES

TH7883AGCCNQA (non sealed quartz window),

TH7883AGCCQ-A (sealed quartz window).

## ABSOLUTE MAXIMUM RATINGS

Same values as standard device, except for :

Storage temperature ..... -55°C to +50°C

Operating temperature ..... ~40°C to +50°C

## OPERATING RANGE

Operating range defines the limits between which the functionality is guaranteed.

Electrical operating range : same as standard TH7883A.

Thermal limits are given in image grade specification.

## STORAGE

The pieces must be stored in darkness. UV coated CCDs with non sealed window must be stored in a dry inert atmosphere, such as nitrogen, to prevent a UV sensitivity decrease.

## OPERATING CONDITIONS

Same values as standard device.

## ELECTROOPTICAL PERFORMANCE

## Performance in visible spectrum

General measurement conditions, performance characteristics and image grade specification are the same as TH7883A H grade, except for PRNU whose maximum value at  $3\sigma$  is  $\pm 13\%$  (typically  $\pm 8\%$ ).

## Image grade in UV spectrum

Temperature range : -40°C to +50°C

The wavelength of measurement is 253 nm for an output level of 300 mV.

Blemish number	Size (pixel number)	Amplitude
20	1	$ \alpha  > 25\%$
10	2 to 10	$13\% <  \alpha  < 25\%$
4	11 to 20	$13\% <  \alpha  < 25\%$

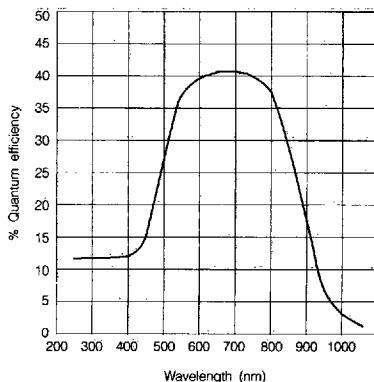
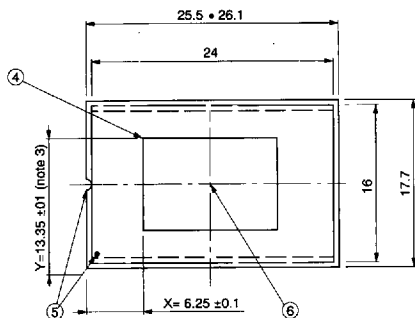
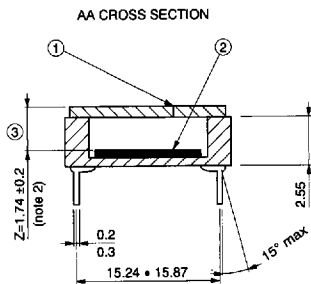
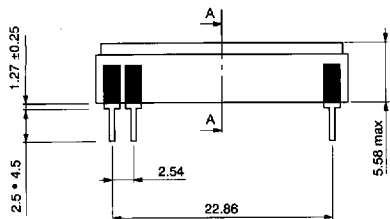
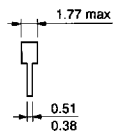

Figure 10 : Typical quantum efficiency with UV coating.

OUTLINE DRAWING : TH 7883A STANDARD AND UV COATED DEVICES



PIN DETAIL



- ① Window
- ② Photosensitive area
- ③ Z = Optical distance between external face of window and photosensitive area (note 1 and 2)
- ④ First pixel of first line (X, Y, Z coordinates)
- ⑤ Index (notch or dot)
- ⑥ Optical center (identical to package center)

dimensions in mm

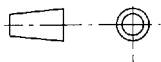

**Note 1 :** The mechanical reference plane is the window faceplate.

**Note 2 :** Variation of Z on the photosensitive area of a device (azimuth) is  $\leq \pm 0.1$  mm. The optical distance Z is not specified when the window is not sealed.

**Note 3 :** Variation of Y between the first pixel of the first line and the first pixel of the last line (tilt) is  $\leq \pm 0.05$  mm.

OUTLINE DRAWING : TH 7883A WITH FIBER OPTIC WINDOW

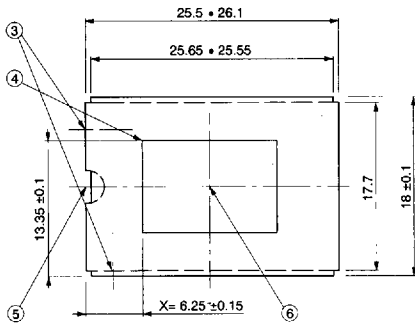
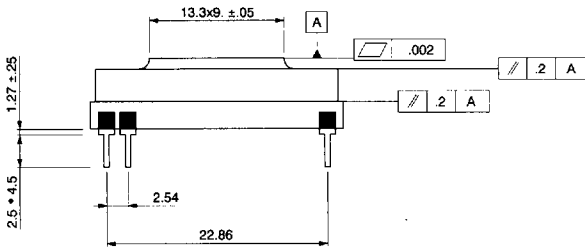

dimensions in mm

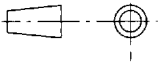

AA SECTION

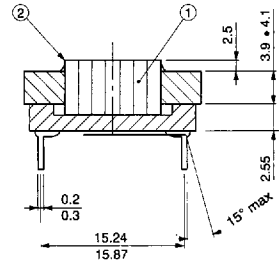

PIN DETAIL

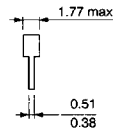

- ① Fiber optic face plate
- ② Focal plane
- ③ Ground lead:  $\varnothing \text{ M2}$  one of these points have to be grounded
- ④ First pixel of first line (X, Y coordinates)
- ⑤ Index (notch)
- ⑥ Optical center referred to the first pixel :  $\begin{matrix} 6.6 \\ 4.4 \end{matrix}$

**ORDERING INFORMATION**

- TH7883AVCH image grade H.
- TH7883AVCHN image grade H non sealed window.
- TH7883AVCBF FO window 1:1.
- TH7883AGCCQ-A UV coated CCD, sealed quartz window.
- TH7883AGCCNQA UV coated CCD, non sealed quartz window

