

3A Bus Terminator Regulator

■ Features

- Ideal for DDR-I and DDR-II applications
- Capable of sourcing and sinking current 1.5A/3A
- Current limiting protection
- Thermal protection
- Current-shoot-through protection
- High accuracy output voltage at full load
- Minimum external components
- Adjustable V_{OUT} by external resistors
- Shutdown for standby or suspend mode operation with high-impedance output
- TO252-5 and SOP-8 **Pb-free** Package

■ Applications

- Mother Board DDR-SDRAM Termination
- Mother Board DDR-II Termination
- Game / Play Station
- Set Top Box
- PCI / AGP Graphics
- IPC
- SCSI-III Bus Termination

■ Pin Assignment

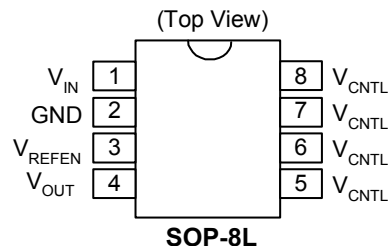
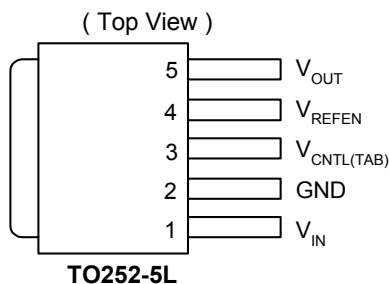

■ General Description

AP1128 is a linear regulator designed as a cost-effective solution for active termination of DDR SDRAM. The converting voltage range is from 1.6V to 6V into a desired output voltage, which is adjusted by two external resistors. The current sourcing and sinking capability of the regulator is up to 1.5A/3A while the output voltage within 2%/3%.

This device provides on-chip thermal shutdown and current limit functions for circuit tolerance of the output fault conditions. SO-8 and TO-252-5L packages are available for all commercial and industrial surface mount applications.

■ Pin Descriptions

Pin Name	Descriptions
V _{IN}	Power Input
V _{CNTL}	Gate Drive Voltage
V _{REFEN}	Reference Voltage Input and Chip Enable
GND	Ground
V _{OUT}	Output Voltage

3A Bus Terminator Regulator

■ Ordering Information

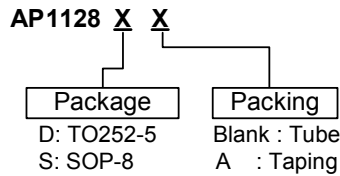

■ Block Diagram

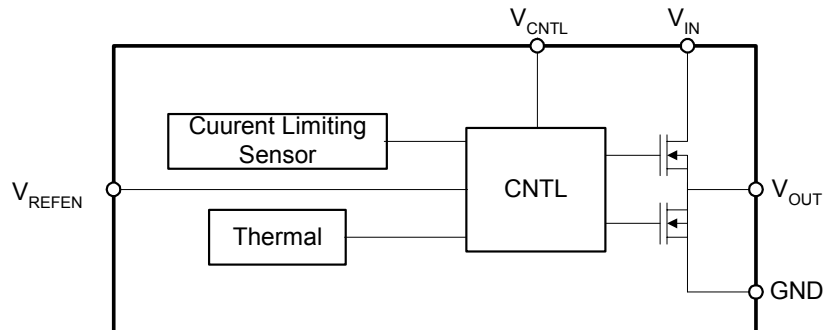

■ Typical Circuit

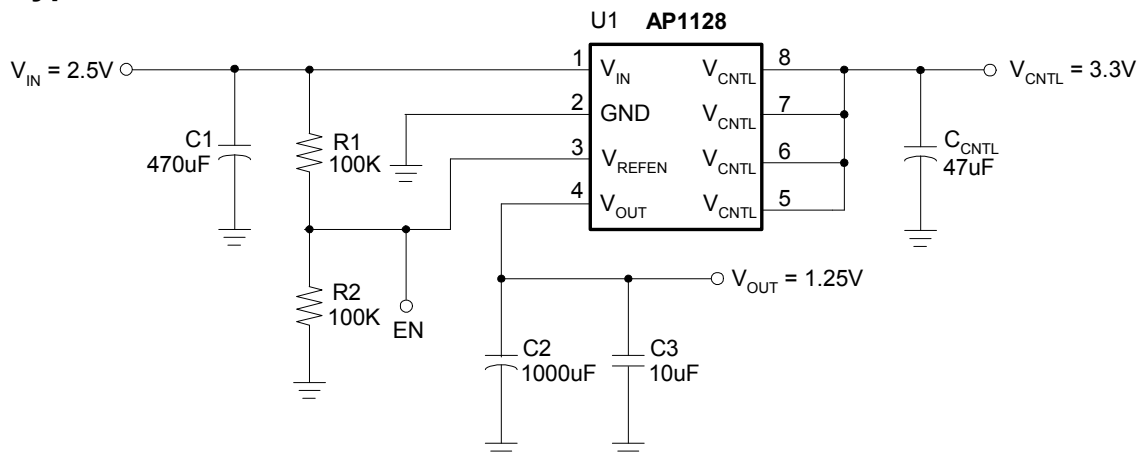

■ Absolute Maximum Ratings

Symbol	Parameter	Rating	Unit	
V_{IN}	Power Input Voltage	6	V	
P_D	Power Dissipation	internal limited		
	HBM ESD Rating	3	KV	
T_{STG}	Storage Temperature	-55 to 150	°C	
T_{Lead}	Lead Temperature (Soldering 5 sec)	260	°C	
θ_{JC}	Thermal Resistance	SOP-8 (Note 3)	20	°C/W
		TO252-5	6	
θ_{JA}	Thermal Resistance	SOP-8	80	°C/W
		TO252-5	40	

3A Bus Terminator Regulator

■ Electrical Characteristics

$V_{IN} = +2.5V$, $V_{CNTL} = +3.3V$, $V_{REFEN} = +1.25V$, $C_{OUT} = 10\mu F$ (Ceramic)

Symbol	Parameter	Conditions	Min.	Typ.	Max.	Unit
V_{OS}	Output Offset Voltage (Note 1)	$I_{OUT}=0A$	-20	-5	20	mV
$ \Delta V_{LOAD} $	Load Regulation	$I_L: 0A \rightarrow 1.5A$	-	0.5	2	%
		$I_L: 0A \rightarrow -1.5A$	-	0.5	2	
V_{IN}	Input Voltage Range (DDR I/II) (Note2)	$V_{CNTL} \geq V_{IN}$	1.6	2.5/1.8	-	V
V_{CNTL}	Gate Drive Voltage Range (Note2)	$V_{CNTL} \geq V_{IN}$	-	3.3	6	V
I_{CNTL}	Operation Current of V_{CNTL}	$I_{OUT} = 0A$	-	3	6	mA
I_{SHDN}	Current in Shutdown	$V_{REFEN} < 0.2V$, $R_L = 180\Omega$	-	10	90	μA
I_Q	Quiescent Current	$I_{OUT}=0A$	-	1	3	mA
Short Circuit Protection						
I_{LIMIT}	Current Limit	SOP-8	-	2	-	A
		TO-252	-	3	-	
Over Temperature Protection						
T_{OS}	Thermal Shutdown Temperature	$3.3V \leq V_{CNTL} \leq 5V$	-	140	-	$^{\circ}C$
Shutdown Function						
	Shutdown Threshold Trigger	Output = High	0.8	-	-	V
	Shutdown Threshold Trigger	Output = Low	-	-	0.2	

Note 1: V_{OS} is the voltage measurement V_{OUT} subtracted from V_{REFEN} .

Note 2: Keep $V_{CNTL} \geq V_{IN}$ at power on/off sequences.

Note 3: Surface mounted on 1 in² copper pad of FR4 board

■ Typical Performance Characteristics

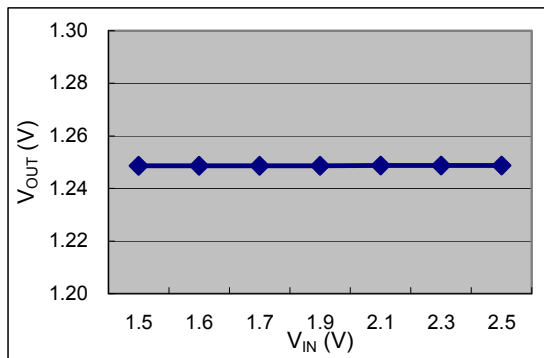

Fig 1. Line Regulation (V_{IN} v.s. V_{OUT})

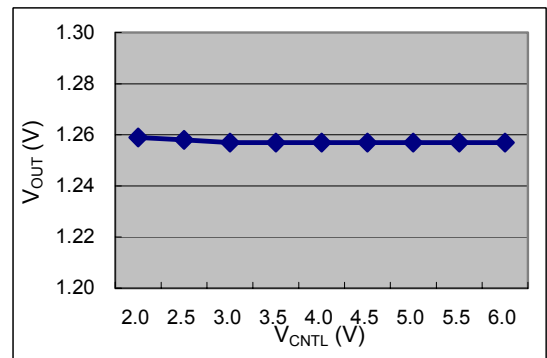

Fig 2. Line Regulation (V_{CNTL} v.s. V_{OUT})

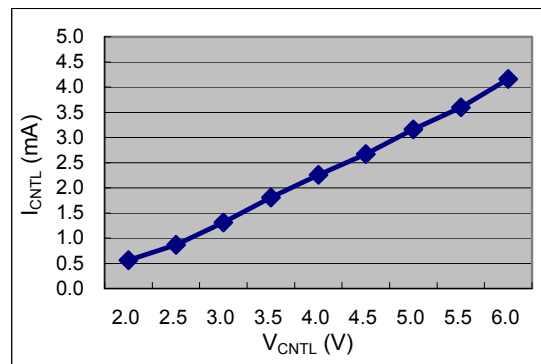

Fig 3. Line Regulation (V_{CNTL} v.s. I_{CNTL})

■ Typical Performance Characteristics (Continued)

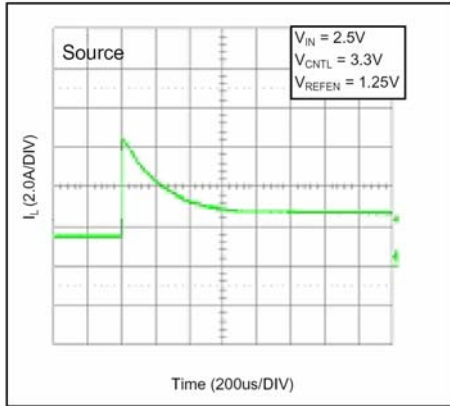

Fig 4. Output Short-Circuit Protection

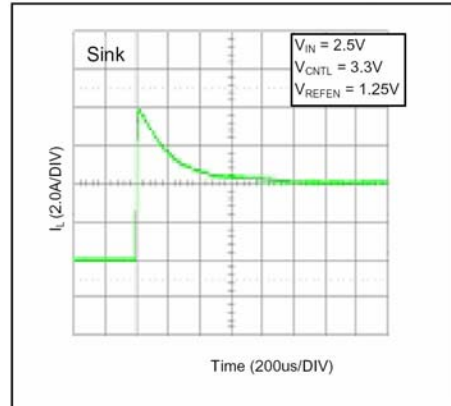
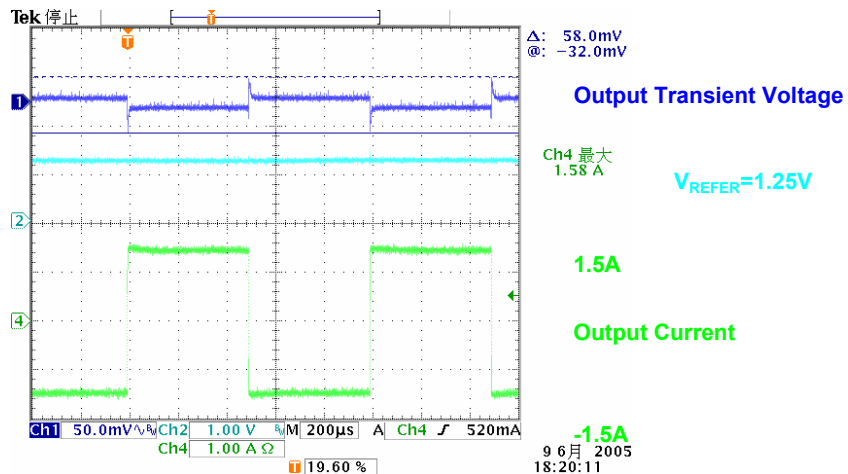
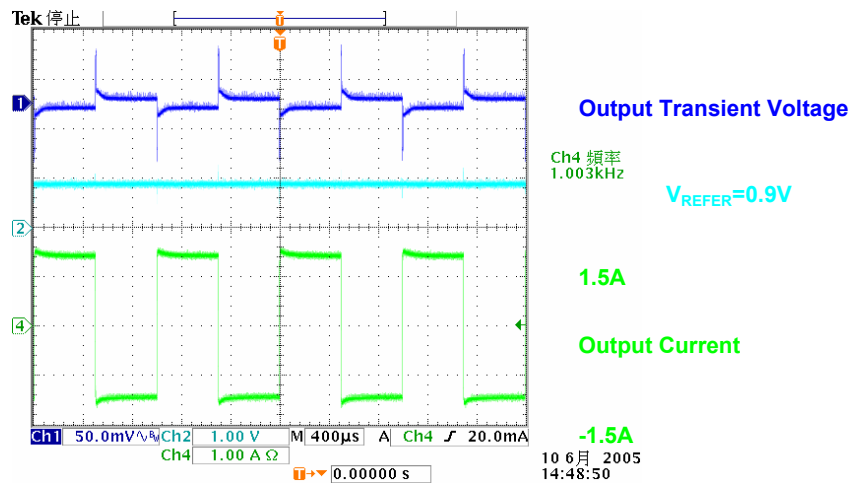

Fig 5. Output Short-Circuit Protection



$V_{IN}=2.5V$, $V_{CNL}=3.3V$, $V_{REFER}=1.25V$, $Temp(IC\ Body) = 98^{\circ}C$
 Fig 7. Transient Response



$V_{IN}=1.8V$, $V_{CNL}=3.3V$, $V_{REFER}=0.9V$
 Fig 8. Transient Response

■ Typical Performance Characteristics (Continued)

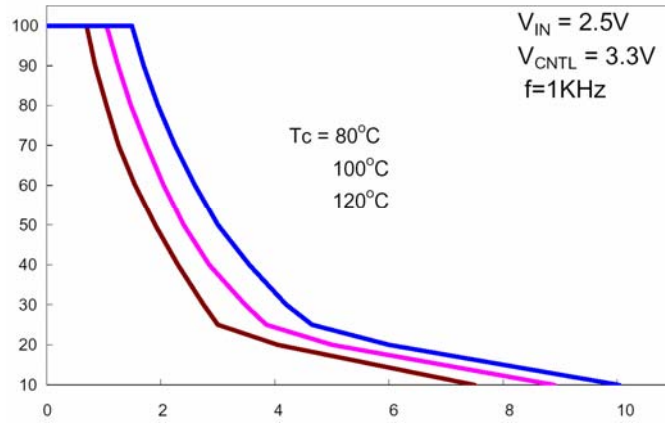
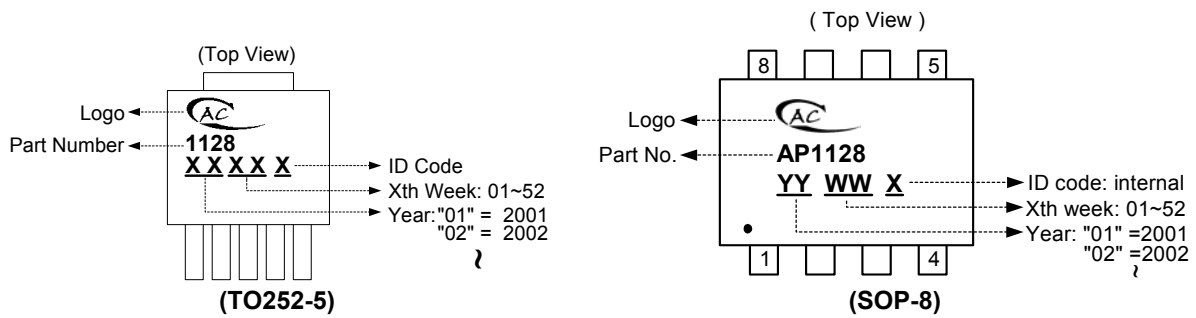

Fig 9. Safe Operating Area

■ Marking Information



3A Bus Terminator Regulator

■ Package Information

(1) Package Type: TO252-5

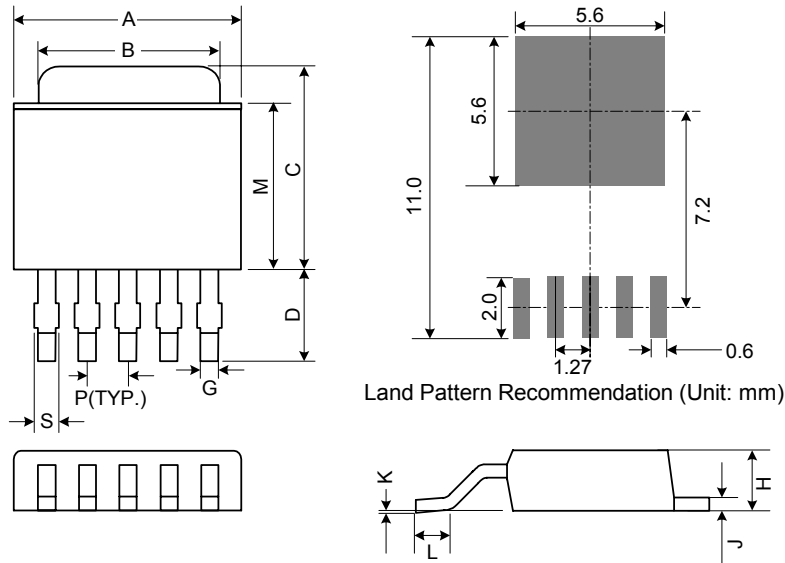

Symbol	Dimensions In Millimeters			Dimensions In Inches		
	Min.	Nom.	Max.	Min.	Nom.	Max.
A	6.35	6.60	6.85	0.250	0.260	0.270
B	5.20	5.35	5.50	0.205	0.211	0.217
C	6.80	7.00	7.30	0.268	0.276	0.287
D	2.20	2.50	2.80	0.087	0.098	0.110
P	1.27 REF.			0.050 REF.		
S	0.50	0.65	0.80	0.020	0.026	0.031
G	0.40	0.50	0.63	0.016	0.020	0.025
H	2.20	2.30	2.40	0.087	0.091	0.094
J	0.45	0.52	0.58	0.018	0.020	0.023
K	0.00	0.08	0.15	0.000	0.003	0.006
L	0.90	1.20	1.63	0.035	0.047	0.064
M	5.40	5.80	6.20	0.213	0.228	0.244

3A Bus Terminator Regulator

■ Package Information (Continued)

(2) Package Type: SOP-8

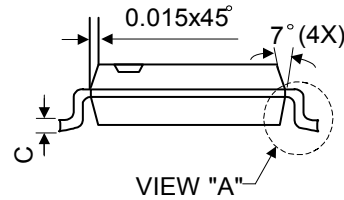
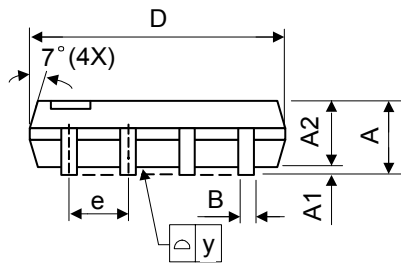
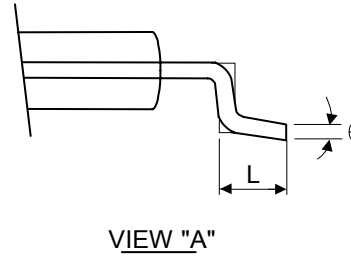
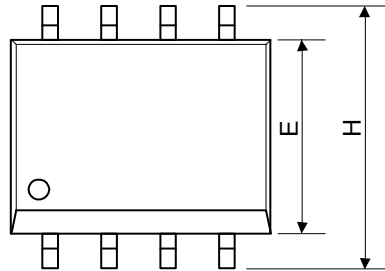

Symbol	Dimensions In Millimeters			Dimensions In Inches		
	Min.	Nom.	Max.	Min.	Nom.	Max.
A	1.40	1.60	1.75	0.055	0.063	0.069
A1	0.10	-	0.25	0.040	-	0.100
A2	1.30	1.45	1.50	0.051	0.057	0.059
B	0.33	0.41	0.51	0.013	0.016	0.020
C	0.19	0.20	0.25	0.0075	0.008	0.010
D	4.80	5.05	5.30	0.189	0.199	0.209
E	3.70	3.90	4.10	0.146	0.154	0.161
e	-	1.27	-	-	0.050	-
H	5.79	5.99	6.20	0.228	0.236	0.244
L	0.38	0.71	1.27	0.015	0.028	0.050
y	-	-	0.10	-	-	0.004
θ	0°	-	8°	0°	-	8°