

CMOS 8-Bit Microcontroller

TMP86CH21U/F

The TMP86CH21 is the high-speed and high-performance 8-bit microcomputer, including ROM, RAM, LCD driver, multi-function timer/counter, serial interface (UART/SIO), a 8-bit AD converter and two clock generators on chip.

Product No.	ROM	RAM	Package	OTP MCU
TMP86CH21U/F	16 K × 8 bits	512 × 8 bits	P-LQFP64-1010-0.50 P-QFP64-1414-0.80A	TMP86PM29AU/AF

Features

- ◆ 8-bit single chip microcomputer TLCS-870/C series
- ◆ Instruction execution time: 0.25 μ s (at 16 MHz)
122 μ s (at 32.768 kHz)
- ◆ 132 types and 731 basic instructions
- ◆ 19 interrupt sources (External: 5, Internal: 14)
- ◆ Input/Output ports (39 pins)
(Out of which 24 pins are also used as SEG pins)
- ◆ 18-bit timer counter: 1 ch
 - Timer, Event counter, Pulse width measurement, Frequency measurement modes
- ◆ 8-bit timer counter: 4 ch
 - Timer, Event counter, PWM output, Programmable divider output, PPG output modes
- ◆ Time Base Timer
- ◆ Divider output function

P-LQFP64-1010-0.50

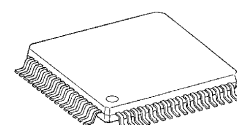

TMP86CH21U

P-QFP64-1414-0.80A

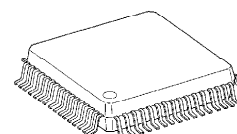

TMP86CH21F

000707EBP1

- For a discussion of how the reliability of microcontrollers can be predicted, please refer to Section 1.3 of the chapter entitled Quality and Reliability Assurance / Handling Precautions.
- TOSHIBA is continually working to improve the quality and reliability of its products. Nevertheless, semiconductor devices in general can malfunction or fail due to their inherent electrical sensitivity and vulnerability to physical stress. It is the responsibility of the buyer, when utilizing TOSHIBA products, to comply with the standards of safety in making a safe design for the entire system, and to avoid situations in which a malfunction or failure of such TOSHIBA products could cause loss of human life, bodily injury or damage to property. In developing your designs, please ensure that TOSHIBA products are used within specified operating ranges as set forth in the most recent TOSHIBA products specifications. Also, please keep in mind the precautions and conditions set forth in the "Handling Guide for Semiconductor Devices," or "TOSHIBA Semiconductor Reliability Handbook" etc..
- The TOSHIBA products listed in this document are intended for usage in general electronics applications (computer, personal equipment, office equipment, measuring equipment, industrial robotics, domestic appliances, etc.). These TOSHIBA products are neither intended nor warranted for usage in equipment that requires extraordinarily high quality and/or reliability or a malfunction or failure of which may cause loss of human life or bodily injury ("Unintended Usage"). Unintended Usage include atomic energy control instruments, airplane or spaceship instruments, transportation instruments, traffic signal instruments, combustion control instruments, medical instruments, all types of safety devices, etc.. Unintended Usage of TOSHIBA products listed in this document shall be made at the customer's own risk.
- The products described in this document are subject to the foreign exchange and foreign trade laws.
- The information contained herein is presented only as a guide for the applications of our products. No responsibility is assumed by TOSHIBA CORPORATION for any infringements of intellectual property or other rights of the third parties which may result from its use. No license is granted by implication or otherwise under any intellectual property or other rights of TOSHIBA CORPORATION or others.
- The information contained herein is subject to change without notice.

- ◆ Watchdog timer
 - Interrupt source/reset output (programmable)
- ◆ Serial interface
 - 8-bit UART/SIO: 1ch
- ◆ 8-bit successive approximation type AD converter
 - Analog input: 8 ch
- ◆ Four key-on wake-up: 4 ch
- ◆ LCD driver/controller
 - Built-in voltage booster for LCD driver
 - With display memory
 - LCD direct drive capability (Max 32 seg × 4 com)
 - 1/4, 1/3, 1/2 duties or static drive are programmably selectable
- ◆ Dual clock operation
 - Single/Dual-clock mode
- ◆ Nine power saving operating modes
 - STOP mode: Oscillation stops. Battery/Capacitor back-up. Port output hold/High-impedance.
 - SLOW 1 mode: Low power consumption operation using low-frequency clock. (High-frequency Stop)
 - SLOW 2 mode: Low power consumption operation using low-frequency clock. (High-frequency Oscillation)
 - IDLE 0 mode: CPU stops, and peripherals operate using high-frequency clock of Time-Base-Timer. Release by falling edge of TBTCCR < TBTCK > setting.
 - IDLE 1 mode: CPU stops, and peripherals operate using high-frequency clock. Release by interrupts.
 - IDLE 2 mode: CPU stops, and peripherals operate using high and low frequency clock. Release by interrupts.
 - SLEEP 0 mode: CPU stops, and peripherals operate using low-frequency clock of Time-Base-Timer. Release by falling edge of TBTCCR < TBTCK > setting.
 - SLEEP 1 mode: CPU stops, and peripherals operate using low-frequency clock. Release by interrupts.
 - SLEEP 2 mode: CPU stops, and peripherals operate using high and low frequency clock. Release by interrupts.
- ◆ Wide operating voltage: 1.8 to 5.5 V at 4.2 MHz/32.768 kHz,
2.7 to 5.5 V at 8 MHz/32.768 kHz,
4.5 to 5.5 V at 16 MHz/32.768 kHz

Pin Assignments (Top View)

P-LQFP64-1010-0.50
 P-QFP64-1414-0.80A

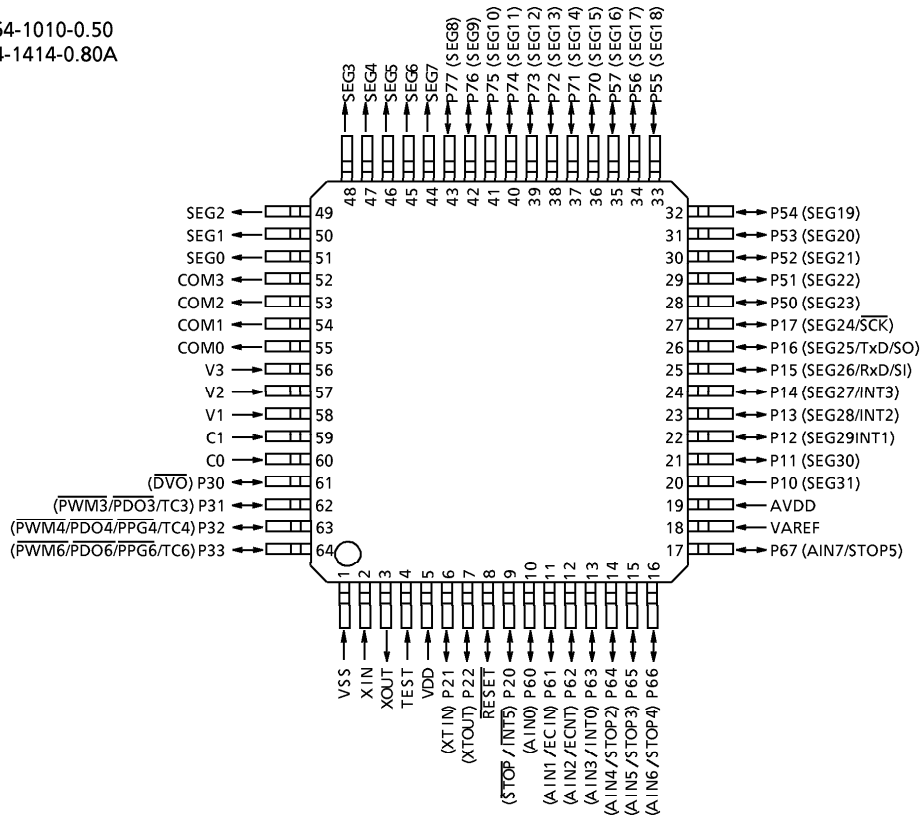

Block Diagram

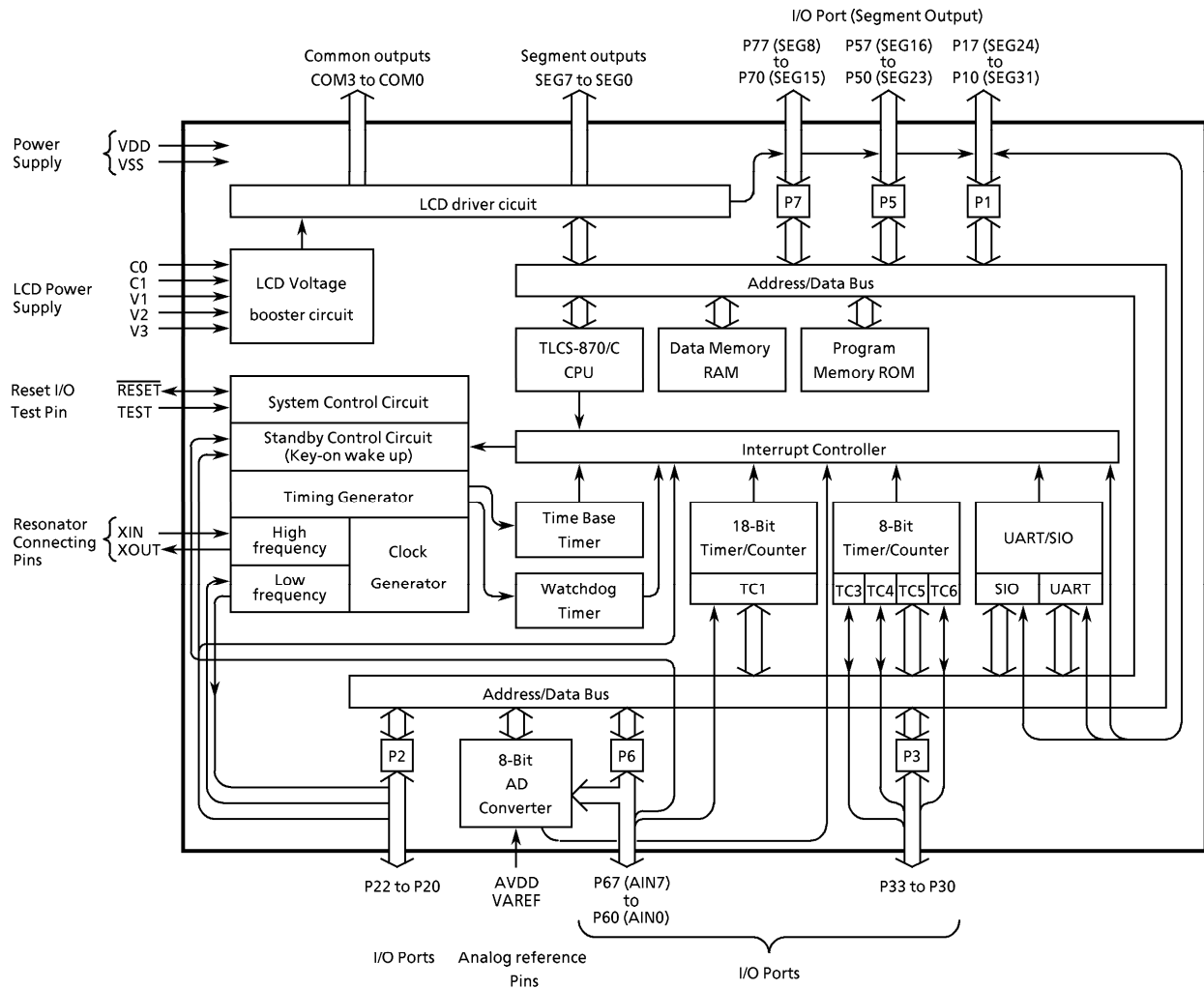

Pin Function

Pin Name	Input/Output	Function		
P17 (SEG24, \overline{SCK})	I/O (I/O)	8-bit input/output port with latch. When used as input port, an external interrupt input, serial interface input/output and UART data input/output, the P1LCR must be set to "0" after setting output latch to "1". When used as a LCD segment output, the P1LCR must be set to "1".	Serial clock input/output	LCD segment outputs.
P16 (SEG25, TxD, SO)	I/O (Output)		UART data output Serial data output	
P15 (SEG26, RxD, SI)	I/O (I/O)		UART data input Serial data input	
P14 (SEG27, INT3)	I/O (I/O)		External interrupt 3 input	
P13 (SEG28, INT2)	I/O (I/O)		External interrupt 2 input	
P12 (SEG29, INT1)	I/O (I/O)		External interrupt 1 input	
P11 (SEG30)	I/O (Output)			
P10 (SEG31)	I/O (Output)			
P22 (XTOUT)	I/O (Output)	3-bit input/output port with latch. When used as an input port, the output latch must be set to "1".	Resonator connecting pins (32.768 kHz) For inputting external clock, XTIN is used and XTOUT is opened.	
P21 (XTIN)	I/O (Input)		External interrupt input 5 or STOP mode release signal input	
P20 ($\overline{INT5}$, \overline{STOP})	I/O (Input)			
P33 (PWM6, $\overline{PDO6}$, $\overline{PPG6}$, TC6)	I/O(I/O)	4-bit programmable input/output port (Nch high current output). When used as a timer/counter output or divider output, the output latch must be set to "1". When used as an input port or timer/counter input, the P3OUTCR must be set to "0" after P3DR is set to "1".	Timer counter 6 input/output	
P32 (PWM4, $\overline{PDO4}$, $\overline{PPG4}$, TC4)	I/O(I/O)		Timer counter 4 input/output	
P31 (PWM3, $\overline{PDO3}$, TC3)	I/O(I/O)		Timer counter 3 input/output	
P30 (\overline{DVO})	I/O(Output)		Divider output	
P57 (SEG16) to P50 (SEG23)	I/O (Output)	8-bit input/output port with latch. When used as a LCD segment output, the P5LCR must be set to "1".	LCD segment outputs	
P67 (AIN7, STOP5)	I/O (Input)	8-bit programmable input/output port (tri-state). Each bit of this port can be individually configured as an input or an output under software control. When used as an analog input, the P6CR must be set to "0" after setting output latch to "0". When used as an input port, a key on wake up input, an external interrupt input and timer/counter input, the P6CR must be set to "0" after setting output latch to "1".	STOP 5 input	AD converter analog inputs
P66 (AIN6, STOP4)	I/O (Input)		STOP 4 input	
P65 (AIN5, STOP3)	I/O (Input)		STOP 3 input	
P64 (AIN4, STOP2)	I/O (Input)		STOP 2 input	
P63 (AIN3, $\overline{INT0}$)	I/O (Input)		External interrupt 0 input	
P62 (AIN2, ECNT)	I/O (Input)		Timer/counter 1 input	
P61 (AIN1, ECIN)	I/O (Input)			
P60 (AIN0)	I/O (Input)			
P77 (SEG8) to P70 (SEG15)	I/O (Output)	8-bit input/output port with latch. When used as a LCD segment output, the P7LCR must be set to "1".	LCD segment outputs	
SEG7 to SEG0	Output	LCD segment outputs		
COM3 to COM0		LCD common outputs		
V3 to V1 C1 to C0	LCD voltage booster pin	LCD voltage booster pin. Capacitors are required between C0 and C1 pin and V1/V2/V3 pin and GND.		
XIN, XOUT	Input Output	Resonator connecting pins for high-frequency clock. For inputting external clock, XIN is used and XOUT is opened.		
\overline{RESET}	I/O	Reset signal input or watchdog timer output/address-trap-reset output		
TEST	Input	Test pin for out-going test. Be fixed to low.		
VDD, VSS	Power Supply	+ 5 V, 0 (GND)		
VAREF		Analog reference voltage inputs (High)		
AVDD		AD circuit power supply		

Operational Description

1. CPU Core Functions

The CPU core consists of a CPU, a system clock controller, and an interrupt controller.

This section provides a description of the CPU core, the program memory, the data memory, the external memory interface, and the reset circuit.

1.1 Memory Address Map

The TMP86CH21 memory consist of 4 blocks: ROM, RAM, DBR (Data Buffer Register) and SFR (Special Function Register). They are all mapped in 64-Kbyte address space. Figure 1-1 shows the TMP86CH21 memory address map. The general-purpose registers are not assigned to the RAM address space.

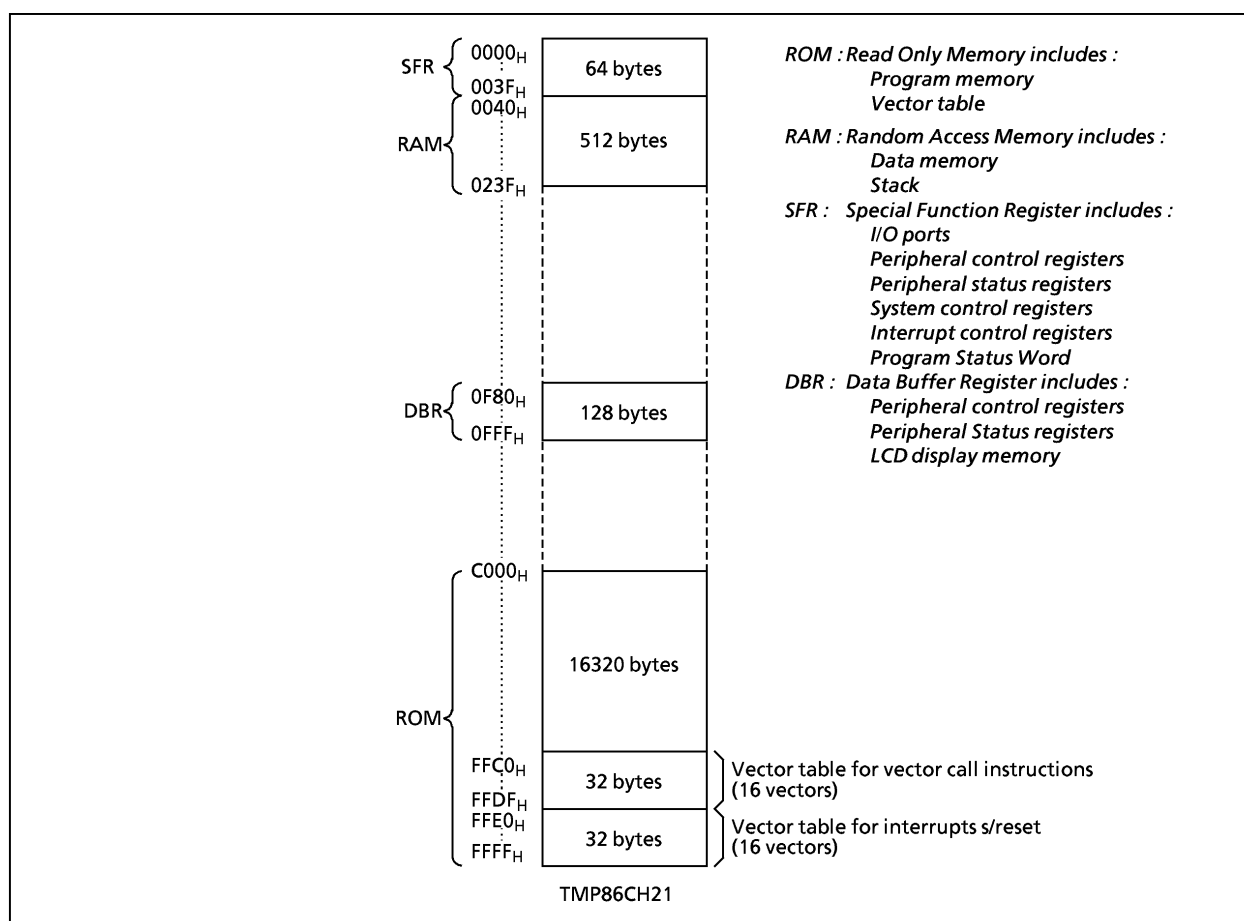

Figure 1-1. Memory Address Map

1.2 Program Memory (ROM)

The TMP86CH21 has a 16 K × 8 bits (address C000_H to FFFF_H) of program memory (mask programmed ROM). However, placing program memory on the internal RAM is deregulated if a certain procedure is executed (See 2.4.5 Address trap).

Electrical Characteristics

Absolute Maximum Ratings ($V_{SS} = 0\text{ V}$)

Parameter	Symbol	Pins	Rating	Unit
Supply Voltage	V_{DD}		- 0.3 to 6.5	V
Input Voltage	V_{IN}		- 0.3 to $V_{DD} + 0.3$	
Output Voltage	V_{OUT1}		- 0.3 to $V_{DD} + 0.3$	
Output Current (Per 1 pin)	I_{OUT1}	P3, P6 Port	- 1.8	mA
	I_{OUT2}	P1, P2, P5, P6, P7 Port	3.2	
	I_{OUT3}	P3 Port	30	
Output Current (Total)	ΣI_{OUT1}	P1, P2, P5, P6, P7 Port	60	
	ΣI_{OUT2}	P3 Port	80	
Power Dissipation [$T_{opr} = 85^\circ\text{C}$]	PD		350	mW
Soldering Temperature (time)	Tslid		260 (10 s)	$^\circ\text{C}$
Storage Temperature	Tstg		- 55 to 125	
Operating Temperature	Topr		- 40 to 85	

Note: The absolute maximum ratings are rated values which must not be exceeded during operation, even for an instant. Any one of the ratings must not be exceeded. If any absolute maximum rating is exceeded, a device may break down or its performance may be degraded, causing it to catch fire or explode resulting in injury to the user. Thus, when designing products which include this device, ensure that no absolute maximum rating value will ever be exceeded.

Recommended Operating Condition ($V_{SS} = 0\text{ V}$, $T_{opr} = -40$ to 85°C)

Parameter	Symbol	Pins	Condition	Min	Max	Unit	
Supply Voltage	V_{DD}		$f_c = 16\text{ MHz}$	NORMAL1, 2 mode	4.5	5.5	V
				IDLE0, 1, 2 mode			
			$f_c = 8\text{ MHz}$	NORMAL1, 2 mode	2.7		
				IDLE0, 1, 2 mode			
			$f_c = 4.2\text{ MHz}$	NORMAL1, 2 mode	1.8		
				IDLE0, 1, 2 mode			
$f_s = 32.768\text{ kHz}$	SLOW1, 2 mode	1.8					
	SLEEP0, 1, 2 mode						
		STOP mode					
Input high Level	V_{IH1}	Except Hysteresis input	$V_{DD} \geq 4.5\text{ V}$	$V_{DD} \times 0.70$	V_{DD}		
	V_{IH2}	Hysteresis input		$V_{DD} \times 0.75$			
	V_{IH3}			$V_{DD} < 4.5\text{ V}$			$V_{DD} \times 0.90$
Input low Level	V_{IL1}	Except Hysteresis input	$V_{DD} \geq 4.5\text{ V}$	0	$V_{DD} \times 0.30$		
	V_{IL2}	Hysteresis input		$V_{DD} \times 0.25$			
	V_{IL3}			$V_{DD} < 4.5\text{ V}$	$V_{DD} \times 0.10$		
Clock Frequency	f_c	XIN, XOUT	$V_{DD} = 1.8$ to 5.5 V	1.0	4.2	MHz	
			$V_{DD} = 2.7$ to 5.5 V		8.0		
			$V_{DD} = 4.5$ to 5.5 V		16.0		
	f_s	XTIN, XTOUT		30.0	34.0	kHz	

Note: The recommended operating conditions for a device are operating conditions under which it can be guaranteed that the device will operate as specified. If the device is used under operating conditions other than the recommended operating conditions (supply voltage, operating temperature range, specified AC/DC values etc.), malfunction may occur. Thus, when designing products which include this device, ensure that the recommended operating conditions for the device are always adhered to.

DC Characteristics

 $(V_{SS} = 0\text{ V}, T_{opr} = -40\text{ to }85^{\circ}\text{C})$

Parameter	Symbol	Pins	Condition	Min	Typ.	Max	Unit	
Hysteresis Voltage	V_{HS}	Hysteresis input		-	0.9	-	V	
Input Current	I_{IN1}	TEST	$V_{DD} = 5.5\text{ V}, V_{IN} = 5.5\text{ V}/0\text{ V}$	-	-	± 2	μA	
	I_{IN2}	Sink Open Drain, Tri-state						
	I_{IN3}	$\overline{\text{RESET}}, \overline{\text{STOP}}$						
Input Resistance	R_{IN1}	TEST Pull-Down		-	70	-	$\text{k}\Omega$	
	R_{IN2}	$\overline{\text{RESET}}$ Pull-Up		100	220	450		
Output Leakage Current	I_{LO}	Sink Open Drain, Tri-state	$V_{DD} = 5.5\text{ V}, V_{OUT} = 5.5\text{ V}/0\text{ V}$	-	-	± 2	μA	
Output High Voltage	V_{OH2}	C-MOS, Tri-st Port	$V_{DD} = 4.5\text{ V}, I_{OH} = -0.7\text{ mA}$	4.1	-	-	V	
Output Low Voltage	V_{OL}	Except XOUT and P3 Port	$V_{DD} = 4.5\text{ V}, I_{OL} = 1.6\text{ mA}$	-	-	0.4		
Output Low Current	I_{OL}	High Current Port (P3 Port)	$V_{DD} = 4.5\text{ V}, V_{OL} = 1.0\text{ V}$	-	20	-	mA	
Supply Current in NORMAL 1, 2 mode	I_{DD}		$V_{DD} = 5.5\text{ V}$ $V_{IN} = 5.3/0.2\text{ V}$ $f_c = 16\text{ MHz}$ $f_s = 32.768\text{ kHz}$	-	7.5	9		
Supply Current in IDLE 0, 1, 2 mode				-	5.5	6.5		
Supply Current in SLOW 1 mode			$V_{DD} = 3.0\text{ V}$ $V_{IN} = 2.8\text{ V}/0.2\text{ V}$ $f_s = 32.768\text{ kHz}$ LCD driver is not enable.	-	18	42		μA
Supply Current in SLEEP 1 mode				-	16	25		
Supply Current in SLEEP 0 mode				-	12	20		
Supply Current in STOP mode				$V_{DD} = 5.5\text{ V}$ $V_{IN} = 5.3\text{ V}/0.2\text{ V}$	-	0.5	10	

Note 1: Typical values show those at $T_{opr} = 25^{\circ}\text{C}$, $V_{DD} = 5\text{ V}$

Note 2: Input current (I_{IN1} , I_{IN2}); The current through pull-up or pull-down resistor is not included.

Note 3: I_{DD} does not include I_{REF} current.

Note 4: The supply currents of SLOW 2 and SLEEP 2 modes are equivalent to IDLE 0, 1, 2.

AD Conversion Characteristics

(V_{SS} = 0.0 V, 4.5 V ≤ V_{DD} ≤ 5.5 V, Topr = -40 to 85°C)

Parameter	Symbol	Condition	Min	Typ.	Max	Unit
Analog Reference Voltage	V _{AREF}		A _{VDD} - 1.5	-	A _{VDD}	V
Power Supply Voltage of Analog Control Circuit	A _{VDD}		V _{DD}			
Analog Reference Voltage Range (Note 4)	ΔV _{AREF}		3.0	-	-	
Analog Input Voltage	V _{AIN}		V _{SS}	-	V _{AREF}	
Power Supply Current of Analog Reference Voltage	I _{REF}	V _{DD} = A _{VDD} = V _{AREF} = 5.5 V V _{SS} = 0.0 V	-	0.6	1.0	mA
Non linearity Error		V _{DD} = A _{VDD} = 5.0 V, V _{SS} = 0.0 V V _{AREF} = 5.0 V	-	-	±1	LSB
Zero Point Error			-	-	±1	
Full Scale Error			-	-	±1	
Total Error			-	-	±2	

(V_{SS} = 0.0 V, 2.7 V ≤ V_{DD} < 4.5 V, Topr = -40 to 85°C)

Parameter	Symbol	Condition	Min	Typ.	Max	Unit
Analog Reference Voltage	V _{AREF}		A _{VDD} - 1.5	-	A _{VDD}	V
Power Supply Voltage of Analog Control Circuit	A _{VDD}		V _{DD}			
Analog Reference Voltage Range (Note 4)	ΔV _{AREF}		2.5	-	-	
Analog Input Voltage	V _{AIN}		V _{SS}	-	V _{AREF}	
Power Supply Current of Analog Reference Voltage	I _{REF}	V _{DD} = A _{VDD} = V _{AREF} = 4.5 V V _{SS} = 0.0 V	-	0.5	0.8	mA
Non linearity Error		V _{DD} = A _{VDD} = 2.7 V, V _{SS} = 0.0 V V _{AREF} = 2.7 V	-	-	±1	LSB
Zero Point Error			-	-	±1	
Full Scale Error			-	-	±1	
Total Error			-	-	±2	

(V_{SS} = 0.0 V, 2.0 V ≤ V_{DD} < 2.7 V, Topr = -40 to 85°C) Note 5(V_{SS} = 0.0 V, 1.8 V ≤ V_{DD} < 2.0 V, Topr = -10 to 85°C) Note 5

Parameter	Symbol	Condition	Min	Typ.	Max	Unit
Analog Reference Voltage	V _{AREF}		A _{VDD} - 0.9	-	A _{VDD}	V
Power Supply Voltage of Analog Control Circuit	A _{VDD}		V _{DD}			
Analog Reference Voltage Range (Note 4)	ΔV _{AREF}	1.8 V ≤ V _{DD} < 2.0 V	1.8	-	-	
		2.0 V ≤ V _{DD} < 2.7 V	2.0	-	-	
Analog Input Voltage	V _{AIN}		V _{SS}	-	V _{AREF}	
Power Supply Current of Analog Reference Voltage	I _{REF}	V _{DD} = A _{VDD} = V _{AREF} = 2.7 V V _{SS} = 0.0 V	-	0.3	0.5	mA
Non linearity Error		V _{DD} = A _{VDD} = 1.8 V, V _{SS} = 0.0 V V _{AREF} = 1.8 V	-	-	±2	LSB
Zero Point Error			-	-	±2	
Full Scale Error			-	-	±2	
Total Error			-	-	±4	

Note 1: The total error includes all errors except a quantization error, and is defined as a maximum deviation from the ideal conversion line.

Note 2: Conversion time is different in recommended value by power supply voltage. About conversion time, please refer to "2.10.2 Register Configuration".

Note 3: Please use input voltage to AIN input Pin in limit of V_{AREF} - V_{SS}. When voltage of range outside is input, conversion value becomes unsettled and gives affect to other channel conversion value.

Note 4: Analog Reference Voltage Range: ΔV_{AREF} = V_{AREF} - V_{SS}

Note 5: When AD is used with V_{DD} < 2.7 V, the guaranteed temperature range varies with the operating voltage.

AC Characteristics

 $(V_{SS} = 0\text{ V}, V_{DD} = 4.5\text{ to }5.5\text{ V}, T_{opr} = -40\text{ to }85^{\circ}\text{C})$

Parameter	Symbol	Condition	Min	Typ.	Max	Unit
Machine Cycle Time	tcy	NORMAL 1, 2 mode	0.25	-	4	μs
		IDLE 1, 2 mode				
		SLOW 1, 2 mode	117.6	-	133.3	
		SLEEP 1, 2 mode				
High Level Clock Pulse Width	twcH	For external clock operation (XIN input)	-	31.25	-	ns
Low Level Clock Pulse Width	twcL	fc = 16 MHz	-	31.25	-	ns
High Level Clock Pulse Width	twcH	For external clock operation (XTIN input)	-	15.26	-	μs
Low Level Clock Pulse Width	twcL	fs = 32.768 kHz	-	15.26	-	μs

 $(V_{SS} = 0\text{ V}, V_{DD} = 2.7\text{ to }4.5\text{ V}, T_{opr} = -40\text{ to }85^{\circ}\text{C})$

Parameter	Symbol	Condition	Min	Typ.	Max	Unit
Machine Cycle Time	tcy	NORMAL 1, 2 mode	0.5	-	4	μs
		IDLE 1, 2 mode				
		SLOW 1, 2 mode	117.6	-	133.3	
		SLEEP 1, 2 mode				
High Level Clock Pulse Width	twcH	For external clock operation (XIN input)	-	62.5	-	ns
Low Level Clock Pulse Width	twcL	fc = 8 MHz	-	62.5	-	ns
High Level Clock Pulse Width	twcH	For external clock operation (XTIN input)	-	15.26	-	μs
Low Level Clock Pulse Width	twcL	fs = 32.768 kHz	-	15.26	-	μs

 $(V_{SS} = 0\text{ V}, V_{DD} = 1.8\text{ to }2.7\text{ V}, T_{opr} = -40\text{ to }85^{\circ}\text{C})$

Parameter	Symbol	Condition	Min	Typ.	Max	Unit
Machine Cycle Time	tcy	NORMAL 1, 2 mode	0.95	-	4	μs
		IDLE 1, 2 mode				
		SLOW 1, 2 mode	117.6	-	133.3	
		SLEEP 1, 2 mode				
High Level Clock Pulse Width	twcH	For external clock operation (XIN input)	-	119.05	-	ns
Low Level Clock Pulse Width	twcL	fc = 4.2 MHz	-	119.05	-	ns
High Level Clock Pulse Width	twcH	For external clock operation (XTIN input)	-	15.26	-	μs
Low Level Clock Pulse Width	twcL	fs = 32.768 kHz	-	15.26	-	μs

Timer Counter 1 input (ECIN) Characteristics

 $(V_{SS} = 0\text{ V}, T_{opr} = -40\text{ to }85^{\circ}\text{C})$

Parameter	Symbol	Condition	Min	Typ.	Max	Unit
TC1 input (ECIN input)	t_{TC1}	Frequency measurement mode $V_{DD} = 4.5\text{ to }5.5\text{ V}$	Single edge count	-	-	16
			Both edge count	-	-	
		Frequency measurement mode $V_{DD} = 2.7\text{ to }4.5\text{ V}$	Single edge count	-	-	8
			Both edge count	-	-	
		Frequency measurement mode $V_{DD} = 1.8\text{ to }2.7\text{ V}$	Single edge count	-	-	4.2
			Both edge count	-	-	

Recommended Oscillating Conditions - 1 ($V_{SS} = 0\text{ V}$, $V_{DD} = 4.5\text{ V to }5.5\text{ V}$, $T_{opr} = -40\text{ to }85^\circ\text{C}$)

Parameter	Oscillator	Oscillation Frequency	Recommended Oscillator	Recommended Constant	
				C ₁	C ₂
High-frequency Oscillation	Ceramic Resonator	16 MHz	MURATA CSALS16M0X55-B0 CSACV16.00MXJ040	7 pF 7pF	7 pF 7pF

Recommended Oscillating Conditions - 2 ($V_{SS} = 0\text{ V}$, $V_{DD} = 2.7\text{ V to }5.5\text{ V}$, $T_{opr} = -40\text{ to }85^\circ\text{C}$)

Parameter	Oscillator	Oscillation Frequency	Recommended Oscillator	Recommended Constant	
				C ₁	C ₂
High-frequency Oscillation	Ceramic Resonator	8 MHz	MURATA CSTS0800MG03 CSTCC8.00MG	15 pF (built-in) 15 pF (built-in)	15 pF (built-in) 15 pF (built-in)

Recommended Oscillating Conditions - 3 ($V_{SS} = 0\text{ V}$, $V_{DD} = 2.0\text{ V to }5.5\text{ V}$, $T_{opr} = -40\text{ to }85^\circ\text{C}$)

Parameter	Oscillator	Oscillation Frequency	Recommended Oscillator	Recommended Constant	
				C ₁	C ₂
High-frequency Oscillation	Ceramic Resonator	4.19 MHz	MURATA CSTS0419MG06 CSTCR4M19G55-R0	47 pF (built-in) 39 pF (built-in)	47 pF (built-in) 39 pF (built-in)

Recommended Oscillating Conditions - 4 ($V_{SS} = 0\text{ V}$, $V_{DD} = 1.8\text{ V to }5.5\text{ V}$, $T_{opr} = -40\text{ to }85^\circ\text{C}$)

Parameter	Oscillator	Oscillation Frequency	Recommended Oscillator	Recommended Constant	
				C ₁	C ₂
High-frequency Oscillation	Ceramic Resonator	4.19 MHz	MURATA CSA4.19MG-951	30 pF	30 pF

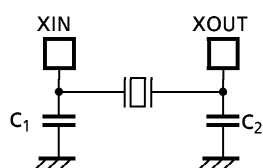

(1) High-frequency Oscillation

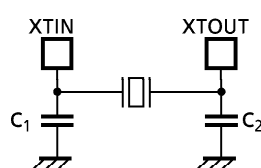

(2) Low-frequency Oscillation

Note 1: An electrical shield by metal shield plate on the surface of IC package is recommended in order to protect the device from the high electric field stress applied from CRT (Cathodic Ray Tube) for continuous reliable operation.

Note 2: The product numbers and specifications of the resonators by Murata Manufacturing Co., Ltd. are subject to change. For up-to-date information, please refer to the following URL;
<http://www.murata.co.jp/search/index.html>