

## IRK.41, .56 SERIES

**THYRISTOR/ DIODE and  
THYRISTOR/ THYRISTOR**

**ADD-A-pak™ GEN V Power Modules**

### Features

- High Voltage
- Industrial Standard Package
- Thick Al metal die and double stick bonding
- Thick copper baseplate
- UL E78996 approved
- 3500V<sub>RMS</sub> isolating voltage

### Benefits

- Up to 1600V
- Full compatible TO-240AA
- High Surge capability
- Easy Mounting on heatsink
- Al<sub>2</sub>O<sub>3</sub> DBC insulator
- Heatsink grounded

45 A  
60 A

### Mechanical Description

The Generation V of Add-A-pak module combine the excellent thermal performance obtained by the usage of Direct Bonded Copper substrate with superior mechanical ruggedness, thanks to the insertion of a solid Copper baseplate at the bottom side of the device. The Cu baseplate allow an easier mounting on the majority of heatsink with increased tolerance of surface roughness and improve thermal spread.

The Generation V of AAP module is manufactured without hard mold, eliminating in this way any possible direct stress on the leads.

The electrical terminals are secured against axial pull-out: they are fixed to the module housing via a click-stop feature already tested and proved as reliable on other IR modules.

### Electrical Description

These modules are intended for general purpose high voltage applications such as high voltage regulated power supplies, lighting circuits, temperature and motor speed control circuits, UPS and battery charger.

### Major Ratings and Characteristics

Parameters	IRK.41	IRK.56	Units
$I_{T(AV)}$ or $I_{F(AV)}$ @ 85°C	45	60	A
$I_{O(RMS)}$ (*)	100	135	A
$I_{TSM}$ @ 50Hz	850	1310	A
$I_{FSM}$ @ 60Hz	890	1370	A
$I^2t$ @ 50Hz	3.61	8.50	KA <sup>2</sup> s
@ 60Hz	3.30	7.82	KA <sup>2</sup> s
$I^2\sqrt{t}$	36.1	85.0	KA <sup>2</sup> √s
$V_{RRM}$ range	400 to 1600		V
$T_{STG}$	- 40 to 125		°C
$T_J$	- 40 to 125		°C

(\*) As AC switch.



## IRK.41, .56 Series

Bulletin I27131 rev. G 10/02

International  
IR Rectifier

### ELECTRICAL SPECIFICATIONS

#### Voltage Ratings

Type number	Voltage Code	$V_{RRM}$ , maximum repetitive peak reverse voltage V	$V_{RSM}$ , maximum non-repetitive peak reverse voltage V	$V_{DRM}$ , max. repetitive peak off-state voltage, gate open circuit V	$I_{RRM}$ $I_{DRM}$ 125°C mA
IRK.41/ .56	04	400	500	400	15
	06	600	700	600	
	08	800	900	800	
	10	1000	1100	1000	
	12	1200	1300	1200	
	14	1400	1500	1400	
	16	1600	1700	1600	

#### On-state Conduction

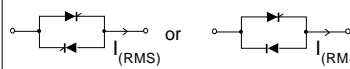
Parameters	IRK.41	IRK.56	Units	Conditions		
$I_{T(AV)}$ Max. average on-state current (Thyristors)	45	60	A	180° conduction, half sine wave, $T_C = 85^\circ\text{C}$		
$I_{F(AV)}$ Maximum average forward current (Diodes)	45	60				
$I_{O(RMS)}$ Max. continuous RMS on-state current. As AC switch	100	135				
$I_{TSM}$ Max. peak, one cycle or non-repetitive on-state $I_{FSM}$ or forward current	850	1310				
	890	1370				t=10ms No voltage t=8.3ms reapplied
	715	1100				100% $V_{RRM}$ reapplied
	750	1150	$T_J = 25^\circ\text{C}$ ,			
	940	1450	no voltage reapplied			
985	1520					
$I^2t$ Max. $I^2t$ for fusing	3.61	8.56	$\text{KA}^2\text{s}$	Initial $T_J = T_J \text{ max.}$		
	3.30	7.82			t=10ms No voltage t=8.3ms reapplied	
	2.56	6.05			100% $V_{RRM}$ reapplied	
	2.33	5.53			$T_J = 25^\circ\text{C}$ ,	
	4.42	10.05			no voltage reapplied	
4.03	9.60					
$I^2\sqrt{t}$ Max. $I^2\sqrt{t}$ for fusing (1)	36.1	85.6	$\text{KA}^2\sqrt{\text{s}}$	t=0.1 to 10ms, no voltage reapplied		
$V_{T(TO)}$ Max. value of threshold voltage (2)	0.88	0.85	V	Low level (3)		
	0.91	0.88		High level (4)		
$r_t$ Max. value of on-state slope resistance (2)	5.90	3.53	$\text{m}\Omega$	Low level (3)		
	5.74	3.41		High level (4)		
$V_{TM}$ Max. peak on-state or forward voltage	1.81	1.54	V	$I_{TM} = \pi \times I_{T(AV)}$		
$V_{FM}$				$I_{FM} = \pi \times I_{F(AV)}$		
$di/dt$ Max. non-repetitive rate of rise of turned on current	150		A/ $\mu\text{s}$	$T_J = 25^\circ\text{C}$ , from $0.67 V_{DRM}$ , $I_{TM} = \pi \times I_{T(AV)}$ , $I_g = 500\text{mA}$ , $t_r < 0.5 \mu\text{s}$ , $t_p > 6 \mu\text{s}$		
$I_H$ Max. holding current	200		mA	$T_J = 25^\circ\text{C}$ , anode supply = 6V, resistive load, gate open circuit		
$I_L$ Max. latching current	400			$T_J = 25^\circ\text{C}$ , anode supply = 6V, resistive load		

(1)  $I^2t$  for time  $t_x = I^2\sqrt{t} \times \sqrt{t_x}$

(2) Average power =  $V_{T(TO)} \times I_{T(AV)} + r_t \times (I_{T(RMS)})^2$

(3)  $16.7\% \times \pi \times I_{AV} < I < \pi \times I_{AV}$

(4)  $I > \pi \times I_{AV}$

Triggering

Parameters	IRK.41	IRK.56	Units	Conditions	
$P_{GM}$ Max. peak gate power	10	10	W		
$P_{G(AV)}$ Max. average gate power	2.5	2.5			
$I_{GM}$ Max. peak gate current	2.5	2.5	A		
$-V_{GM}$ Max. peak negative gate voltage	10		V	Anode supply = 6V resistive load	
$V_{GT}$ Max. gate voltage required to trigger	4.0				$T_J = -40^\circ\text{C}$
	2.5				$T_J = 25^\circ\text{C}$
	1.7		$T_J = 125^\circ\text{C}$		
$I_{GT}$ Max. gate current required to trigger	270		mA	Anode supply = 6V resistive load	
	150				$T_J = 25^\circ\text{C}$
	80				$T_J = 125^\circ\text{C}$
$V_{GD}$ Max. gate voltage that will not trigger	0.25		V	$T_J = 125^\circ\text{C}$ , rated $V_{DRM}$ applied	
$I_{GD}$ Max. gate current that will not trigger	6		mA	$T_J = 125^\circ\text{C}$ , rated $V_{DRM}$ applied	

Blocking

Parameters	IRK.41	IRK.56	Units	Conditions
$I_{RRM}$ Max. peak reverse and off-state leakage current at $V_{RRM}$ , $V_{DRM}$	15		mA	$T_J = 125^\circ\text{C}$ , gate open circuit
$V_{INS}$ RMS isolation voltage	2500 (1 min) 3500 (1 sec)		V	50 Hz, circuit to base, all terminals shorted
dv/dt Max. critical rate of rise of off-state voltage (5)	500		V/ $\mu\text{s}$	$T_J = 125^\circ\text{C}$ , linear to 0.67 $V_{DRM}$ , gate open circuit

(5) Available with dv/dt = 1000V/ $\mu\text{s}$ , to complete code add S90 i.e. IRKT41/16AS90.

Thermal and Mechanical Specifications

Parameters	IRK.41	IRK.56	Units	Conditions
$T_J$ Junction operating temperature range	- 40 to 125		°C	
$T_{stg}$ Storage temp. range	- 40 to 125			
$R_{thJC}$ Max. internal thermal resistance, junction to case	0.23	0.20	K/W	Per module, DC operation
$R_{thCS}$ Typical thermal resistance case to heatsink	0.1			Mounting surface flat, smooth and greased
T Mounting torque $\pm 10\%$ to heatsink busbar	5		Nm	A mounting compound is recommended and the torque should be rechecked after a period of 3 hours to allow for the spread of the compound
	3			
wt Approximate weight	110 (4)		gr (oz)	
Case style	TO-240AA		JEDEC	

$\Delta R$  Conduction (per Junction)

(The following table shows the increment of thermal resistance  $R_{thJC}$  when devices operate at different conduction angles than DC)

Devices	Sine half wave conduction					Rect. wave conduction					Units
	180°	120°	90°	60°	30°	180°	120°	90°	60°	30°	
IRK.41	0.11	0.13	0.17	0.23	0.34	0.09	0.14	0.18	0.23	0.34	°C/W
IRK.56	0.09	0.11	0.13	0.18	0.27	0.07	0.11	0.14	0.19	0.28	

# IRK.41, .56 Series

Bulletin I27131 rev. G 10/02

## Ordering Information Table

<b>Device Code</b>						
<b>IRK</b>	<b>T</b>	<b>56</b>	<b>/</b>	<b>16</b>	<b>A</b>	<b>S90</b>
①	②	③		④	⑤	⑥

  

<p><b>1</b> - Module type</p> <p><b>2</b> - Circuit configuration (See Circuit Configuration table below)</p> <p><b>3</b> - Current code **</p> <p><b>4</b> - Voltage code (See Voltage Ratings table)</p> <p><b>5</b> - A : Gen V</p> <p><b>6</b> - dv/dt code: S90 = dv/dt 1000 V/μs No letter = dv/dt 500 Vμs</p>	<p>** Available with no auxiliary cathode.</p> <p>To specify change: 41 to 42 56 to 57</p> <p>e.g. : IRKT57/16A etc.</p>
--	--

IRK.57 types  
With no auxiliary cathode

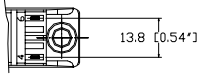

## Outline Table

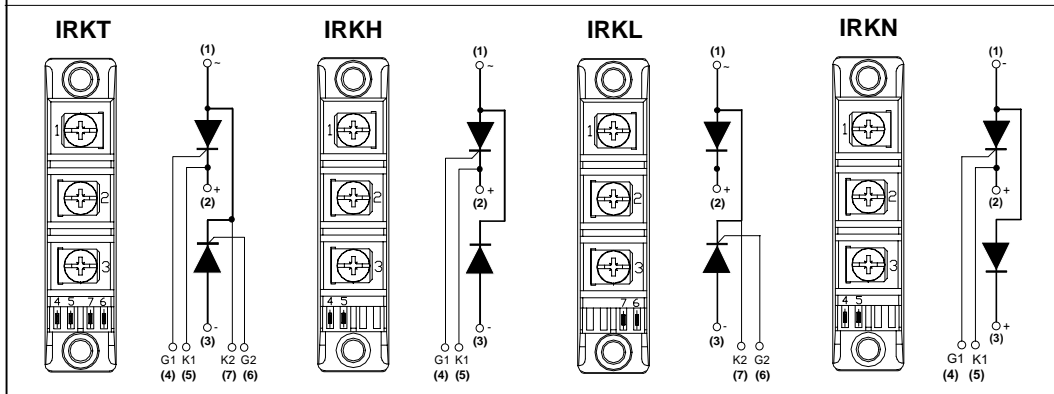
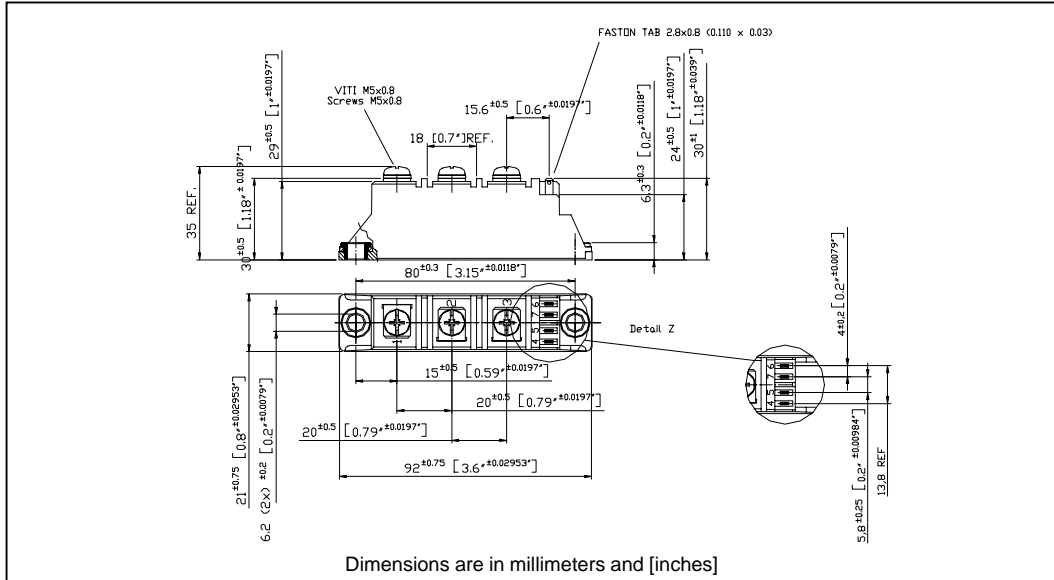

**NOTE: To order the Optional Hardware see Bulletin I27900**

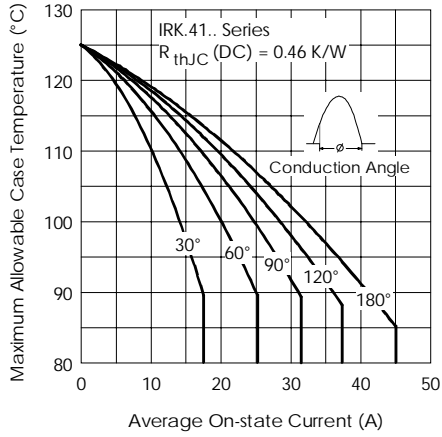

Fig. 1 - Current Ratings Characteristics

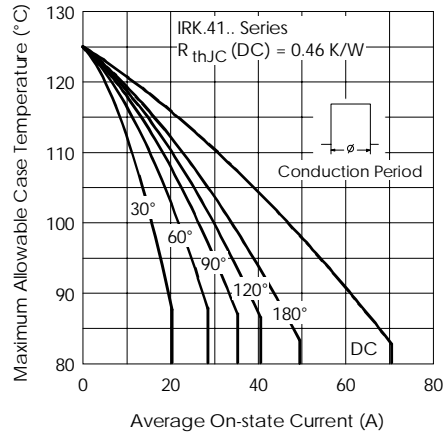

Fig. 2 - Current Ratings Characteristics

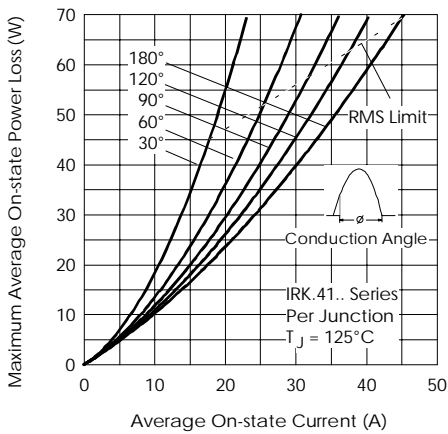

Fig. 3 - On-state Power Loss Characteristics

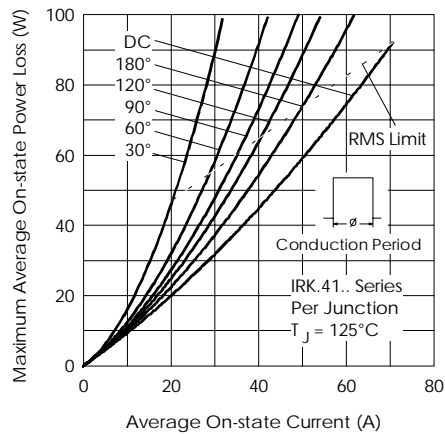

Fig. 4 - On-state Power Loss Characteristics

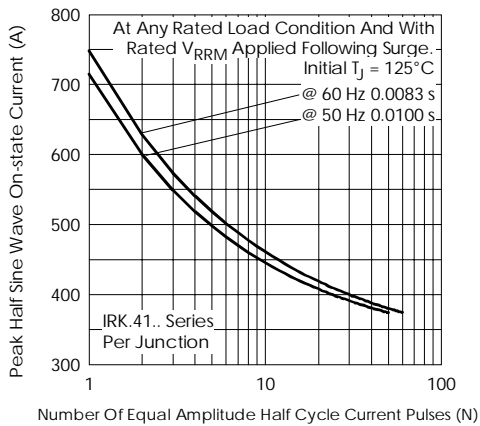

Fig. 5 - Maximum Non-Repetitive Surge Current

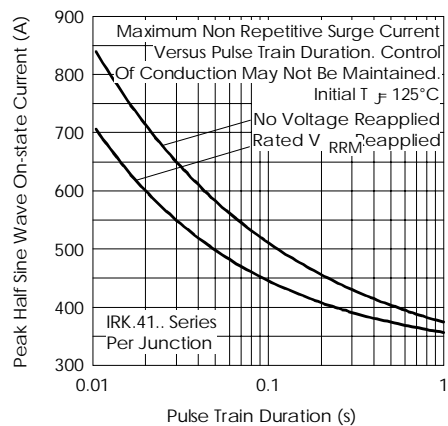

Fig. 6 - Maximum Non-Repetitive Surge Current

# IRK.41, .56 Series

Bulletin I27131 rev. G 10/02

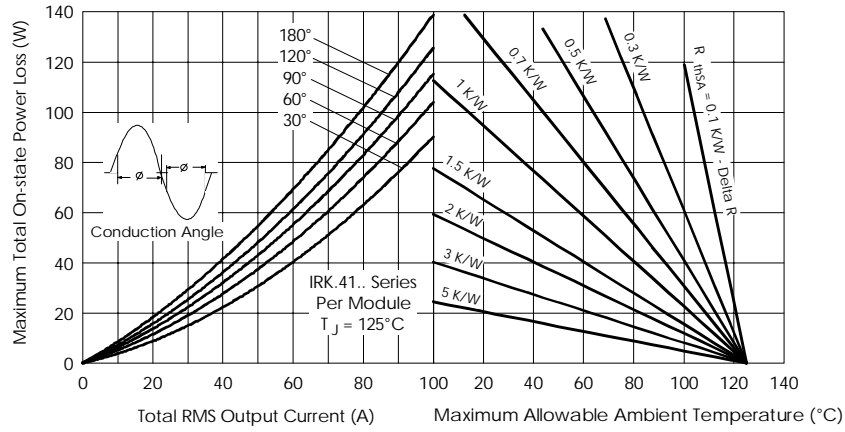

Fig. 7 - On-state Power Loss Characteristics

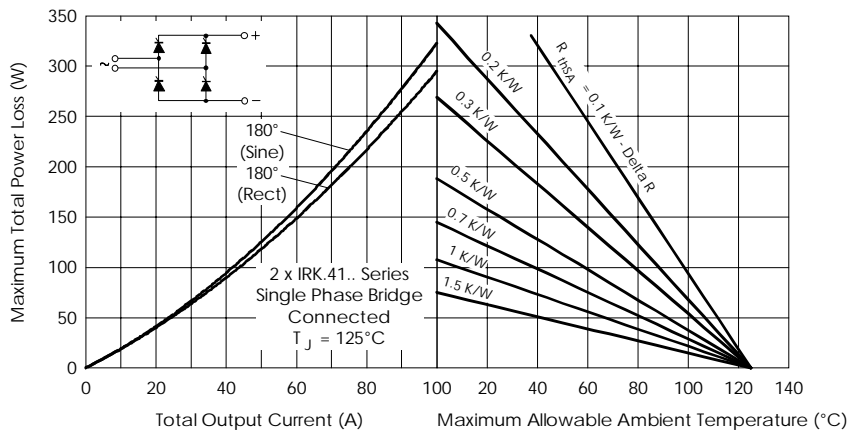

Fig. 8 - On-state Power Loss Characteristics

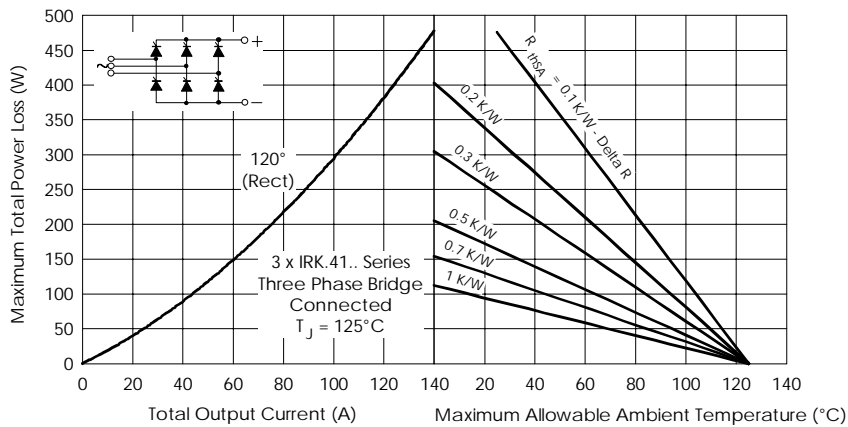

Fig. 9 - On-state Power Loss Characteristics

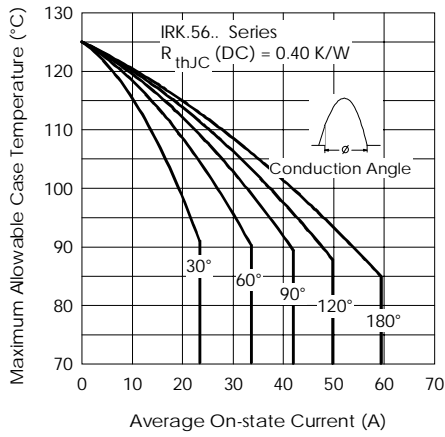

Fig. 10 - Current Ratings Characteristics

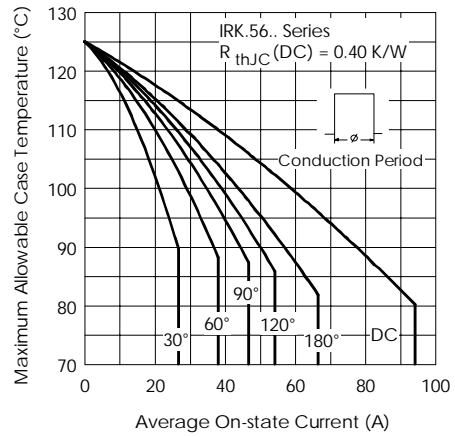

Fig. 11 - Current Ratings Characteristics

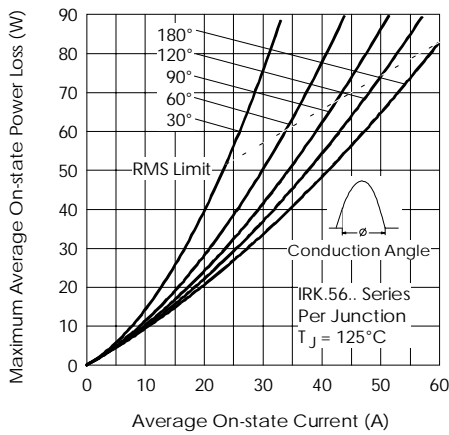

Fig. 12 - On-state Power Loss Characteristics

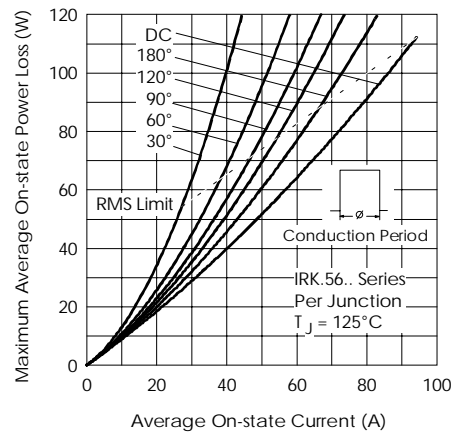

Fig. 13 - On-state Power Loss Characteristics

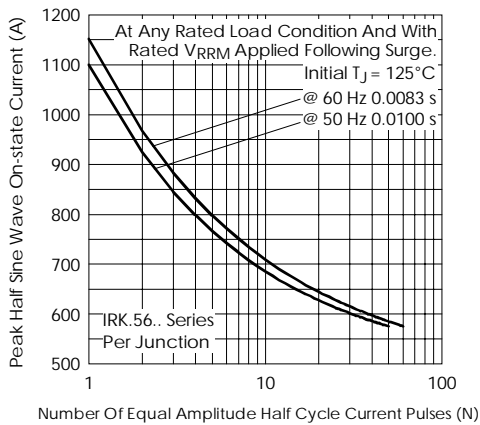

Fig. 14 - Maximum Non-Repetitive Surge Current

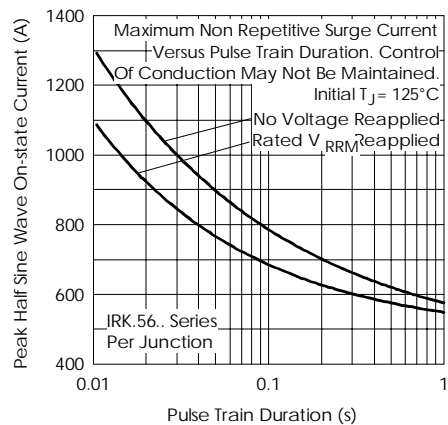

Fig. 15 - Maximum Non-Repetitive Surge Current

# IRK.41, .56 Series

Bulletin I27131 rev. G 10/02

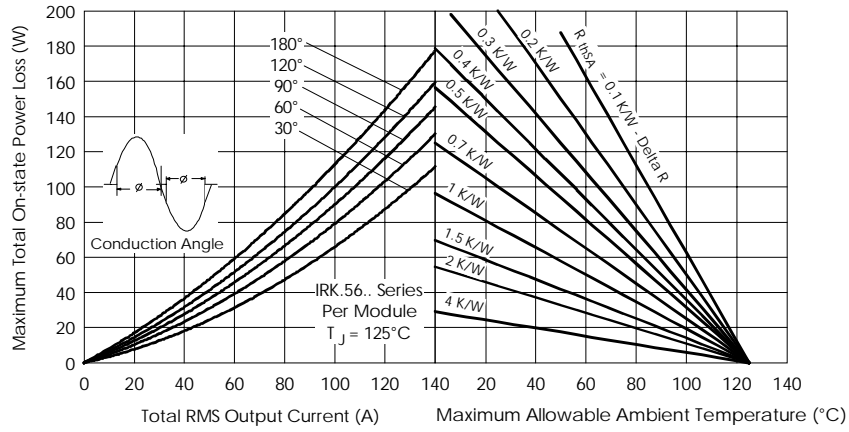

Fig. 16 - On-state Power Loss Characteristics

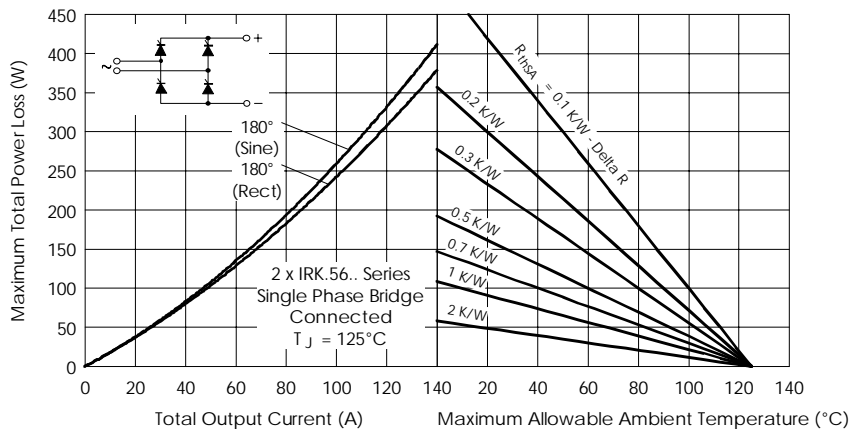

Fig. 17 - On-state Power Loss Characteristics

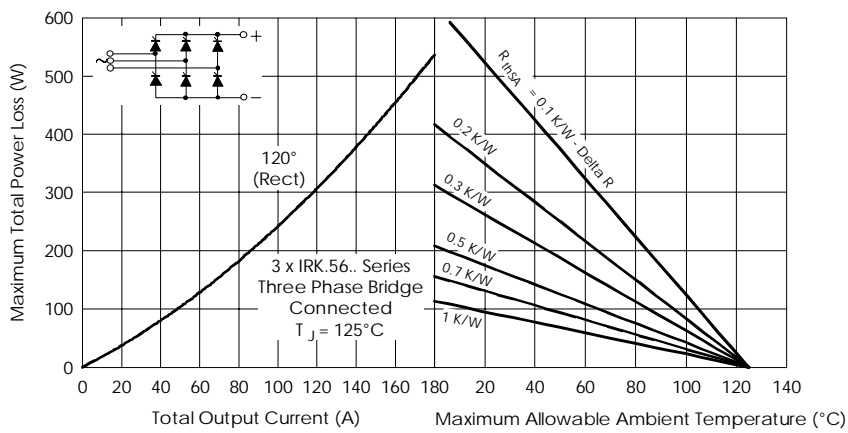

Fig. 18 - On-state Power Loss Characteristics



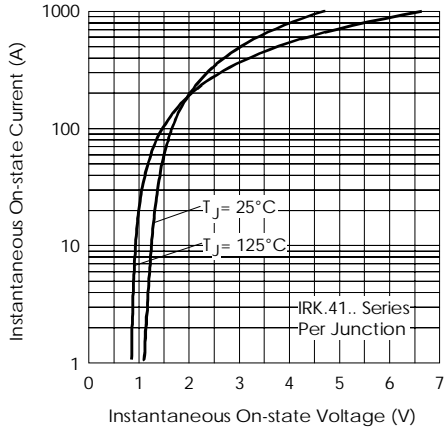

Fig. 19 - On-state Voltage Drop Characteristics

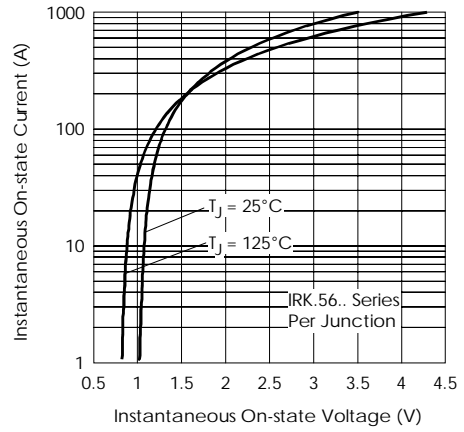

Fig. 20 - On-state Voltage Drop Characteristics

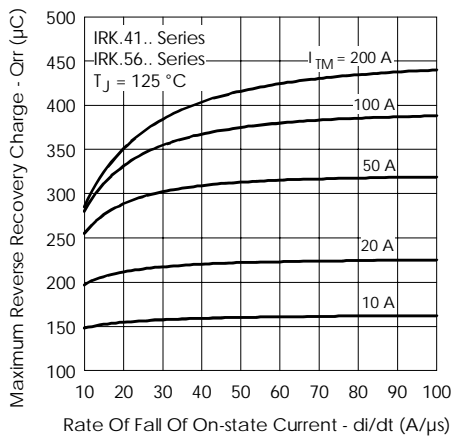

Fig. 21 - Recovery Charge Characteristics

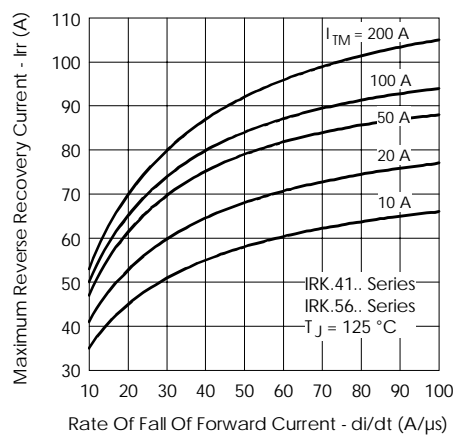

Fig. 22 - Recovery Current Characteristics

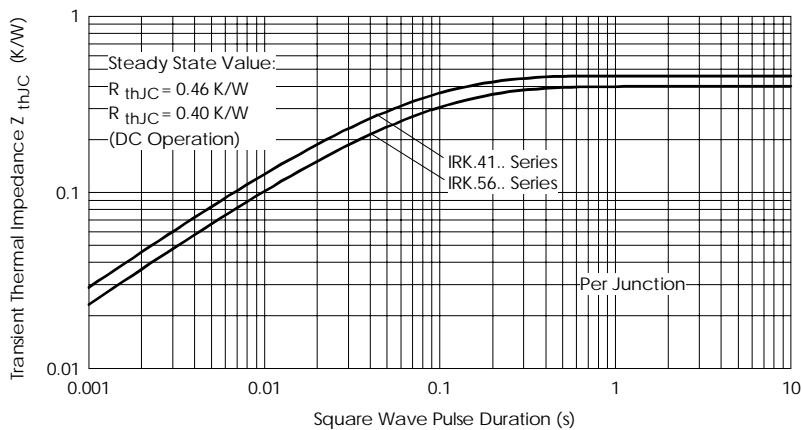

Fig. 23 - Thermal Impedance  $Z_{thJC}$  Characteristics

# IRK.41, .56 Series

Bulletin I27131 rev. G 10/02

International  
**IR** Rectifier

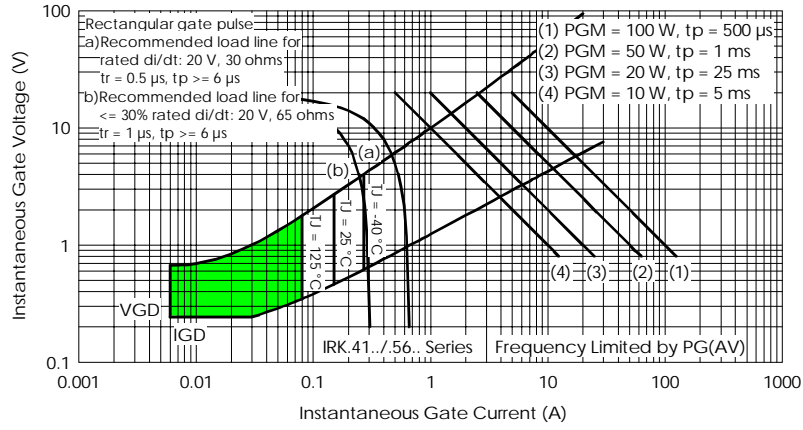

Fig. 24 - Gate Characteristics

Data and specifications subject to change without notice.  
 This product has been designed and qualified for Industrial Level.  
 Qualification Standards can be found on IR's Web site.

International  
**IR** Rectifier

IR WORLD HEADQUARTERS: 233 Kansas St., El Segundo, California 90245, USA Tel: (310) 252-7105

TAC Fax: (310) 252-7309

Visit us at [www.irf.com](http://www.irf.com) for sales contact information. 10/02