

TC4007UBP/UBF

C²MOS DIGITAL INTEGRATED CIRCUIT
SILICON MONOLITHIC

TC4007UBP/TC4007UBF DUAL COMPLEMENTARY PAIR PLUS INVERTER

TC4007UBP/UBF contains three elements of P-channel enhancement type MOS FET and three elements of N-channel enhancement type MOS FET. One pair of P-channel and N-channel functions as inverter and remaining two pairs provide the respective outputs of source and drain separately. Depending on how connections are made, the versatile applications such as inverter, waveform shaping circuits, NAND(NOR) gates, linear amplifiers, clocked gates, transmission gates and high fan-out buffers are easily obtainable.

MAXIMUM RATINGS

CHARACTERISTIC	SYMBOL	RATING	UNIT
DC Supply Voltage	V _{DD}	V _{SS} -0.5 ~ V _{SS} +20	V
Input Voltage	V _{IN}	V _{SS} -0.5 ~ V _{DD} +0.5	V
Output Voltage *	V _{OUT}	V _{SS} -0.5 ~ V _{DD} +0.5	V
DC Input Current	I _{IN}	±10	mA
Power Dissipation	P _D	300(DIP)/180(MFP)	mW
Operating Ambient Temperature Range	T _A	-40 ~ 85	°C
Storage Temperature Range	T _{stg}	-65 ~ 150	°C
Lead Temp./Time	T _{sol}	260°C · 10 sec	

* Applicable for D_p, D_N, S_P, S_N and OUT terminals.

LOGIC DIAGRAM

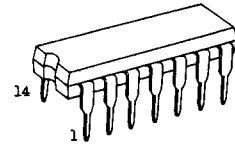
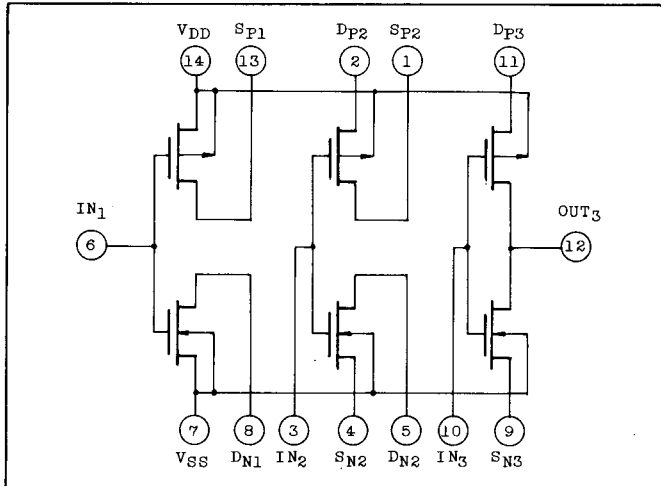

DIP14 (SD14A-P)

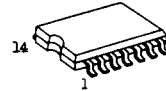

MFP14 (F14GB-P)

PIN ASSIGNMENT

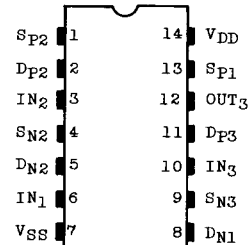

(TOP VIEW)

RECOMMENDED OPERATING CONDITIONS (V_{SS}=0V)

CHARACTERISTIC	SYMBOL	TEST CONDITION	MIN.	TYP.	MAX.	UNIT
DC Supply Voltage	V _{DD}		3	-	18	V
Input Voltage	V _{IN}		0	-	V _{DD}	V

STATIC ELECTRICAL CHARACTERISTICS (V_{SS}=0V)

CHARACTERISTIC	SYM-BOL	TEST CONDITION	V _{DD} (V)	-40°C		25°C			85°C		UNIT	
				MIN.	MAX.	MIN.	TYP.	MAX.	MIN.	MAX.		
High-Level Output Voltage	V _{OH}	I _{OUT} < 1μA V _{IN} =V _{SS}	5	4.95	-	4.95	5.00	-	4.95	-	V	
			10	9.95	-	9.95	10.00	-	9.95	-		
			15	14.95	-	14.95	15.00	-	14.95	-		
Low-Level Output Voltage	V _{OL}	I _{OUT} < 1μA V _{IN} =V _{DD}	5	-	0.05	-	0.00	0.05	-	0.05	V	
			10	-	0.05	-	0.00	0.05	-	0.05		
			15	-	0.05	-	0.00	0.05	-	0.05		
Output High Current	I _{OH}	V _{OH} =4.6V V _{OH} =2.5V V _{OH} =9.5V V _{OH} =13.5V V _{IN} =V _{SS}	5	-0.61	-	-0.51	-1.0	-	-0.42	-	mA	
			5	-2.5	-	-2.1	-4.0	-	-1.7	-		
			10	-1.5	-	-1.3	-2.2	-	-1.1	-		
			15	-4.0	-	-3.4	-9.0	-	-2.8	-		
Output Low Current	I _{OL}	V _{OL} =0.4V V _{OL} =0.5V V _{OL} =1.5V V _{IN} =V _{DD}	5	0.61	-	0.51	1.5	-	0.42	-	mA	
			10	1.5	-	1.3	3.8	-	1.1	-		
			15	4.0	-	3.4	15.0	-	2.8	-		
Input High Voltage	V _{IH}	V _{OUT} =0.5V V _{OUT} =1.0V V _{OUT} =1.5V I _{OUT} < 1μA	5	4.0	-	4.0	3.0	-	4.0	-	V	
			10	8.0	-	8.0	6.5	-	8.0	-		
			15	12.0	-	12.0	9.5	-	12.0	-		
Input Low Voltage	V _{IL}	V _{OUT} =4.5V V _{OUT} =9.0V V _{OUT} =13.5V I _{OUT} < 1μA	5	-	1.0	-	3.0	1.0	-	1.0	V	
			10	-	2.0	-	3.5	2.0	-	2.0		
			15	-	3.0	-	5.5	3.0	-	3.0		
Input Current	"H" Level	I _{IH}	V _{IH} =18V	18	-	0.1	-	10 ⁻⁵	0.1	-	1.0	μA
	"L" Level	I _{IL}	V _{IL} =0V	18	-	-0.1	-	-10 ⁻⁵	-0.1	-	-1.0	
Quiescent Device Current	I _{DD}	V _{IN} =V _{SS} , V _{DD} *	5	-	0.25	-	0.001	0.25	-	7.5	μA	
			10	-	0.5	-	0.001	0.5	-	15		
			15	-	1.0	-	0.002	1.0	-	30		

* All valid input combinations.

TC4007UBP/UBF

DYNAMIC ELECTRICAL CHARACTERISTICS ($T_a=25^\circ\text{C}$, $V_{SS}=0\text{V}$, $C_L=50\text{pF}$, INVERTER)

CHARACTERISTIC	SYMBOL	TEST CONDITION	V_{DD} (V)	MIN.	TYP.	MAX.	UNIT
Output Transition Time (Low to High)	t_{TLH}		5	-	80	180	ns
			10	-	50	90	
			15	-	40	70	
Output Transition Time (High to Low)	t_{THL}		5	-	80	150	
			10	-	50	80	
			15	-	40	60	
Propagation Delay Time (Low to High)	t_{pLH}		5	-	55	110	ns
			10	-	25	60	
			15	-	20	50	
Propagation Delay Time (High to Low)	t_{pHL}		5	-	40	110	
			10	-	20	60	
			15	-	15	50	
Input Capacitance	C_{IN}			-	5	7.5	pF

CIRCUIT AND WAVEFORM FOR MEASUREMENT OF DYNAMIC CHARACTERISTICS

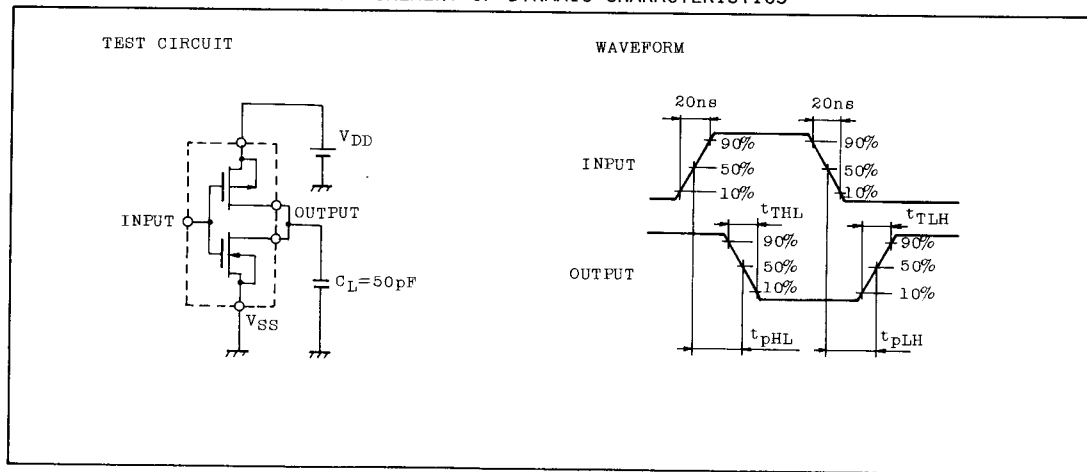

TYPICAL APPLICATION

1. TREE LOGIC

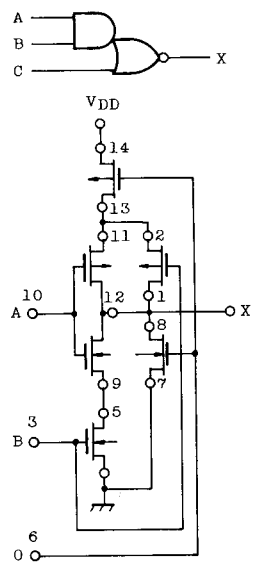

2. CLOCKED INVERTER

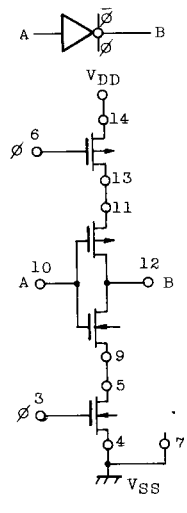

3. ANALOG DATA SELECTOR

