

Single Operational Amplifiers

TBA 221; TBB 741
TBA 222; TBB 742

1

Features

- NPN input
- High differential input voltage
- Short-circuit proof
- High voltage gain
- High supply voltage 44 V
- Wide temperature range (TBA 222, TBB 742)
- Push-pull output
- B S1-version for high quality

Bipolar IC

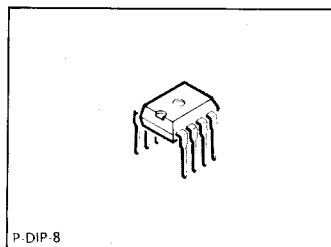

Applications

- Amplifier
- Comparator

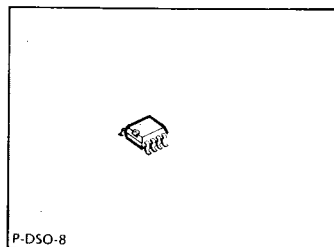

Type	Ordering Code	Package	Color Code
☐ TBA 221 B	Q67000-A281	P-DIP-8	—
☐ TBA 222 B	Q67000-A2280	P-DIP-8	—
TBA 222 B S1	Q67000-A8057	P-DIP-8	—
■ ☐ TBB 741 G	Q67000-A1498	P-DSO-8 (SMD)	blue/brown
■ ☐ TBB 742 G	Q67000-A2395-G403	P-DSO-8 (SMD)	red/green

■ = Not for new design

These op amps are short-circuit proof to $+V_S$, $-V_S$. The input offset voltage can be very easily compensated. Very few external components are required due to the internal frequency compensation. The gain reduction by 6 dB/octave yields a very good stability.

Circuit Diagram

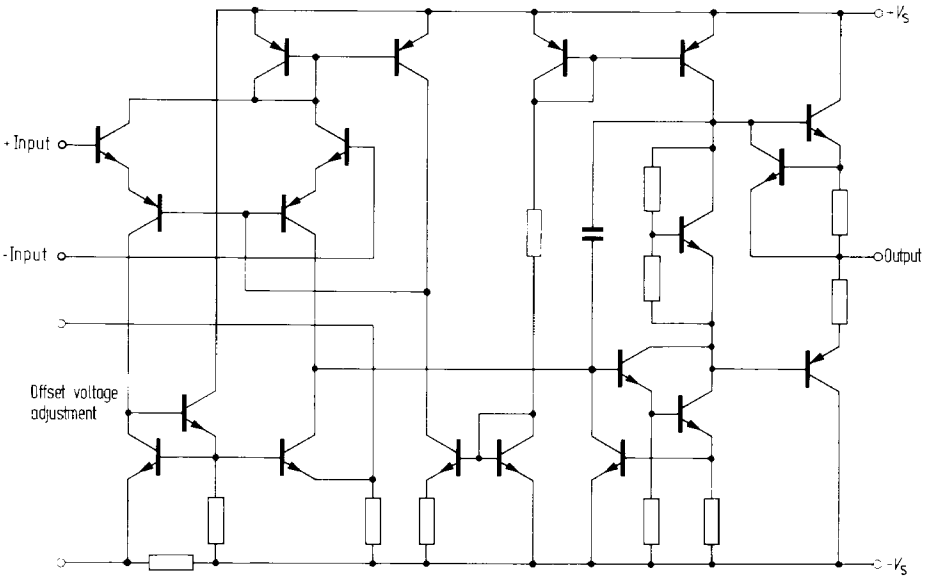

Pin Configurations
(top view)

TBA 221 B
TBA 222 B
TBA 222 B S1

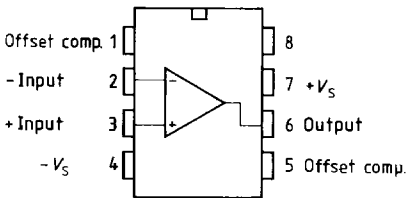

TBB 741 G
TBB 742 G

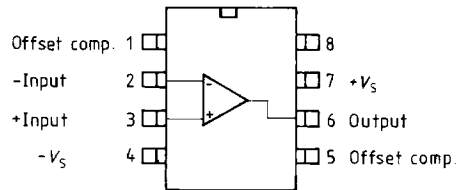

Absolute Maximum Ratings

Parameter	Symbol	Limit Values		Unit
		TBA 221 TBB 741	TBA 222 TBB 742	
Supply voltage	V_S	± 18	± 22	V
Input voltage: $V_S = \pm 4$ to ± 15 V $V_S \geq 15$ V	V_I	$\pm V_S$	$\pm V_S$	V
	V_{I1}	± 15	± 15	V
Differential input voltage	V_{ID}	± 30	± 30	V
Output short-circuit duration ¹⁾	t_{QSC}	∞	∞	
Junction temperature	T_J	150	150	°C
Storage temperature range	T_{stg}	-55 to 125	-65 to 125	°C
Thermal resistance system – air TBA 221B/222B; BS1 TBB 741 G/742 G	$R_{th SA}$	100	100	K/W
	$R_{th SA}$	200	200	K/W

1) Short circuit may be to $+V_S$, $-V_S$, or 0, whereby maximum ratings like T_J must not be exceeded.

Operating Range

Supply voltage	V_S	± 4 to ± 18	± 4 to ± 22	V
Ambient temperature	T_A	0 to 70	-55 to 125	°C

Characteristics

$V_S = \pm 15$ V

Parameter	Symbol	Limit Values $T_A = 25$ °C			Limit Values $T_A = 0$ °C to 70 °C		Unit
		min.	typ.	max.	min.	max.	
Input offset voltage $R_G \leq 10$ k Ω	V_{IO}	-6		6	-7.5	7.5	mV
Setting range of V_{IO}	V_{IO}	6	± 15	-6			mV
Input offset current	I_{IO}	-200	± 20	200	-300	300	nA
Input current	I_I		80	500		800	nA
Supply current	I_S		1.7	2.8		2.8	mA
Pos. output short-circuit current	I_{QSC+}	15	20	25			mA
Neg. output short-circuit current	I_{QSC}	-25	-20	-15			mA
Input resistance	R_I	300	2000				k Ω
Input capacitance	C_I		1.4				pF
Output resistance	R_Q		75				Ω
Control range $R_G \geq 10$ k Ω	$V_{Q PP}$	13	± 14	-12.5			V
$R_L \geq 2$ k Ω	$V_{Q PP}$	11	± 13	-11			V
Common-mode input voltage range	V_{IC}	$-V_S + 3$		$V_S - 3$			V

Characteristics

$V_S = \pm 15\text{ V}$

Parameter	Symbol	Limit Values $T_A = 25\text{ }^\circ\text{C}$			Limit Values $T_A = 0\text{ }^\circ\text{C}$ to $70\text{ }^\circ\text{C}$		Unit
		min.	typ.	max.	min.	max.	
Open-loop voltage gain $V_{O\text{ pp}} = \pm 10\text{ V}, R_L \geq 2\text{ k}\Omega$	G_{VO}	86	100		84		dB
Common-mode rejection ($R_G \leq 10\text{ k}\Omega$)	K_{CMR}	70	90				dB
Supply voltage rejection	k_{SVR}		30	150			$\mu\text{V/V}$
Transient response of output voltage at $G_V = 1$: Rise time, $V_I = 20\text{ mV}$, $R_L = 2\text{ k}\Omega$; $C_L \leq 100\text{ pF}$	t_r		0.3				μs
Overshoot			5				%
Slew rate ¹⁾ $R_L \leq 2\text{ k}\Omega$	SR		0.5				$\text{V}/\mu\text{s}$
Temperature coefficient of V_{IO}	α_{VIO}		3				$\mu\text{V/K}$
Temperature coefficient of I_{IO}	α_{IIO}		0.4				nA/K

Characteristics (TBA 222, TBB 742)

$V_S = \pm 15\text{ V}$

Input offset voltage $R_G \leq 10\text{ k}\Omega$	V_{IO}	-4		4	-5.5	5.5	mV
Setting range of V_{IO}	V_{IO}	6	± 15	-6			mV
Input offset current	I_{IO}	-100	± 20	100	-400	400	nA
Input current	I_I		80	350		1200	nA
Supply current	I_S		1.7	2.8		2.8	mA
Pos. output short-circuit current	I_{QSC+}	15	20	25			mA
Neg. output short-circuit current	I_{QSC-}	-25	-20	-15			mA
Input resistance	R_I	300	2000				$\text{k}\Omega$
Input capacitance	C_I		1.4				pF
Output resistance	R_Q		75				Ω
Control range $R_L \geq 10\text{ k}\Omega$ $R_L \geq 2\text{ k}\Omega$	$V_{O\text{ pp}}$ $V_{Q\text{ pp}}$	13 11	± 14 ± 13	-12.5 -11			V V
Common-mode input voltage range	V_{IC}	$-V_S+3$		V_S-3			V
Open-loop voltage gain $V_{O\text{ pp}} = \pm 10\text{ V}, R_L \geq 2\text{ k}\Omega$	G_{VO}	94	106		88		dB
Common-mode rejection $R_G \leq 10\text{ k}\Omega$	K_{CMR}	80	90				dB
Supply voltage rejection	k_{SVR}		30	100			$\mu\text{V/V}$

1) For the relationship between power bandwidth and slew rate refer to "Introduction – Operational Amplifiers"

Characteristics (TBA 222, TBA 742)

$V_S = \pm 15 \text{ V}$

Parameter	Symbol	Limit Values $T_A = 25^\circ\text{C}$			Limit Values $T_A = 0^\circ\text{C}$ to 70°C		Unit
		min.	typ.	max.	min.	max.	
Transient response of output voltage at $G_V = 1$: Rise time, $V_i = 20 \text{ mV}$, $R_L = 2 \text{ k}\Omega$, $C_L \leq 100 \text{ pF}$	t_r		0.3				μs
Overshoot			5				%
Slew rate ¹⁾ $R_L \leq 2 \text{ k}\Omega$	SR		0.5				$\text{V}/\mu\text{s}$
Temperature coefficient of V_{IO}	α_{VIO}		3				$\mu\text{V}/\text{K}$
Temperature coefficient of I_{IO}	α_{IIO}		0.4				nA/K

TBA 222 B S1

The TBA 222 B S1 is similar to TBA 222 B, however, with special quality features.

- 72 hours electrically preaged at $T_A = 50^\circ\text{C}$, $V_S \pm 22 \text{ V}$ corresponding to the circuit shown below
- Noise $< 5 \mu\text{Vs}$ in accordance with DIN 45405

Circuit, Preaging for TBA 222 B S1

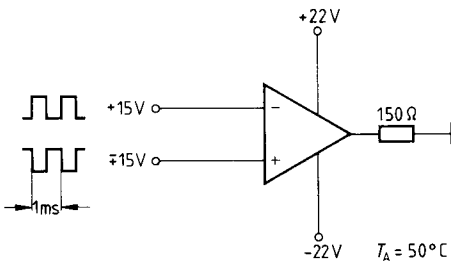

¹⁾ For the relationship between power bandwidth and slew rate refer to **“Introduction – Operational Amplifier”**

Open-loop voltage gain versus supply voltage

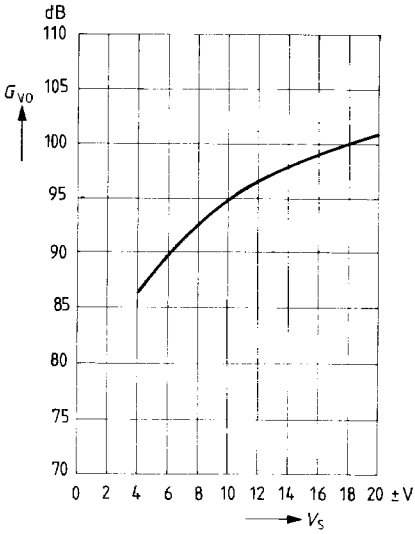

Output voltage versus supply voltage

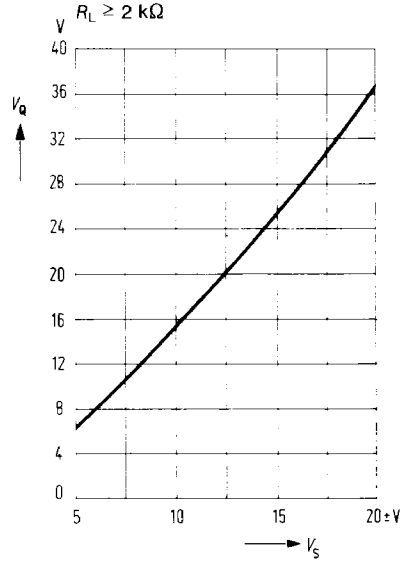

Common-mode range versus supply voltage

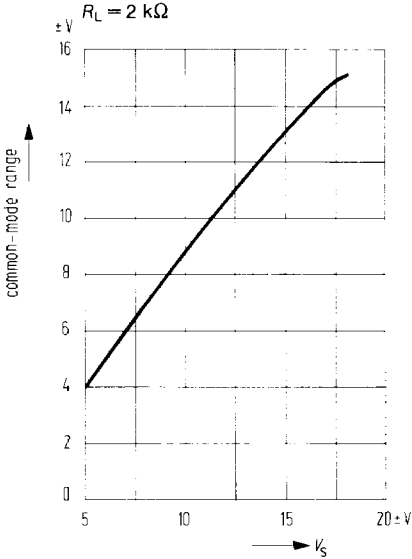

Output short-circuit current versus ambient temperature

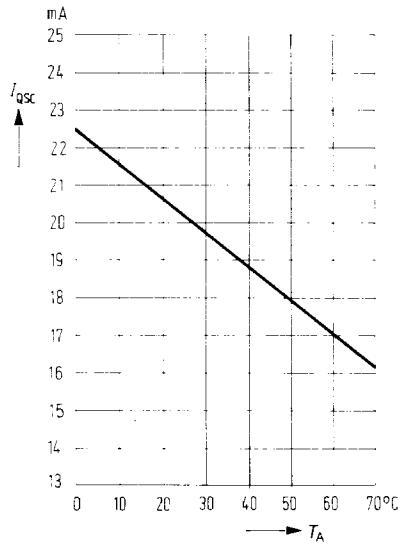

Input current versus ambient temperature
 $V_S = \pm 15\text{ V}$

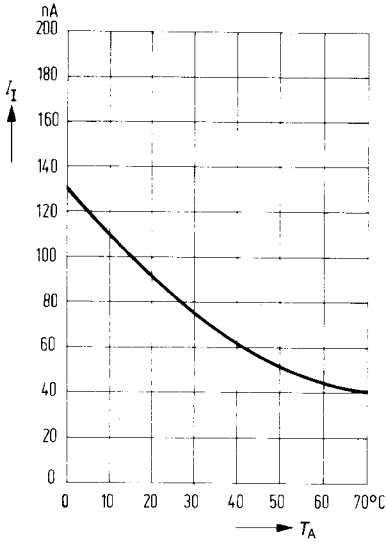

Input resistance versus ambient temperature
 $V_S = \pm 15\text{ V}$

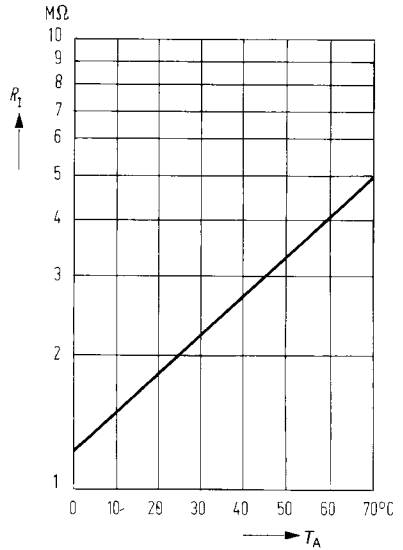

Input offset current versus supply voltage

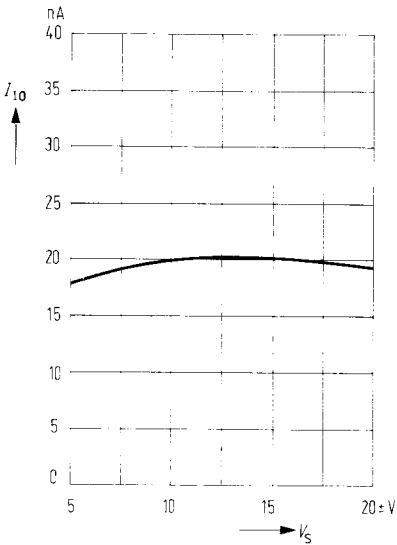

Input offset current versus ambient temperature
 $V_S = \pm 15\text{ V}$

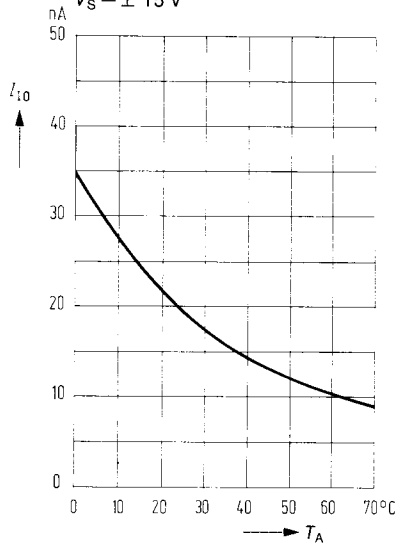

Output voltage versus load resistance
 $V_S = \pm 15\text{ V}$

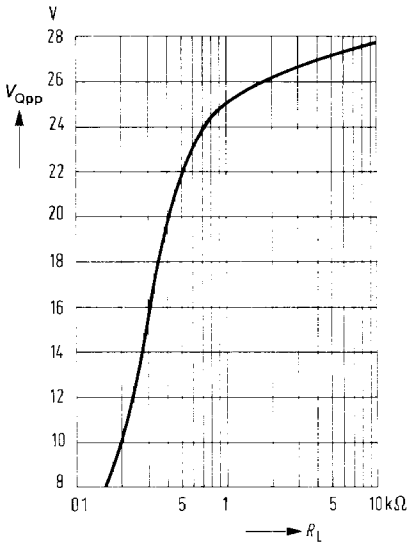

Phase response of open-loop voltage gain
Phase versus frequency
 $V_S = \pm 15\text{ V}$

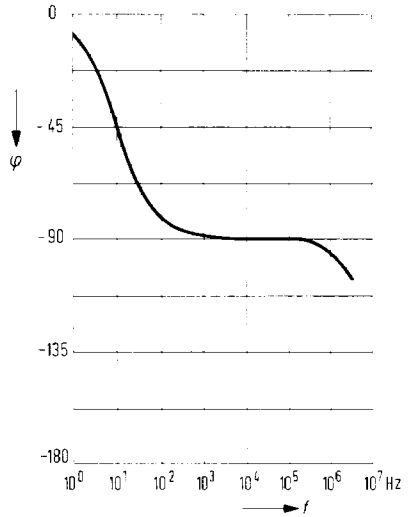

Output voltage versus frequency
 $V_S = \pm 15\text{ V}; R_L = 10\text{ k}\Omega$

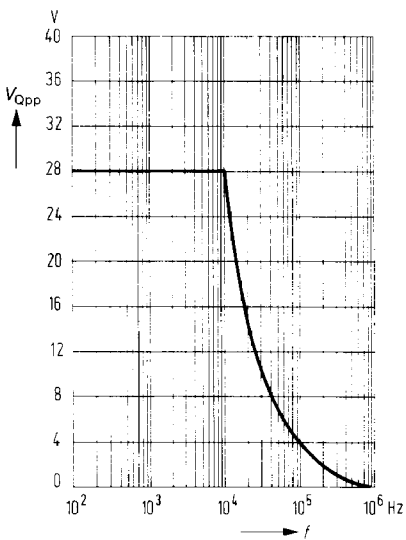

Input resistance and input capacitance versus frequency

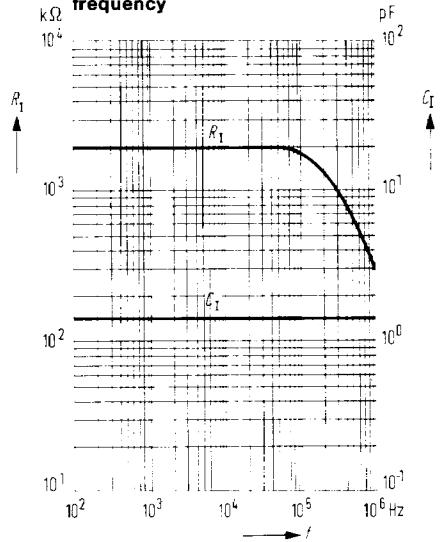

Output resistance versus frequency

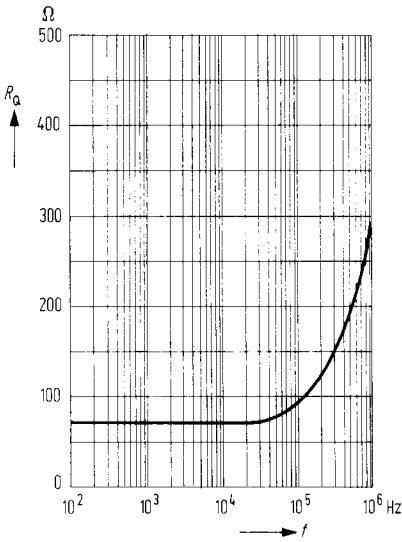

Open-loop voltage gain versus frequency

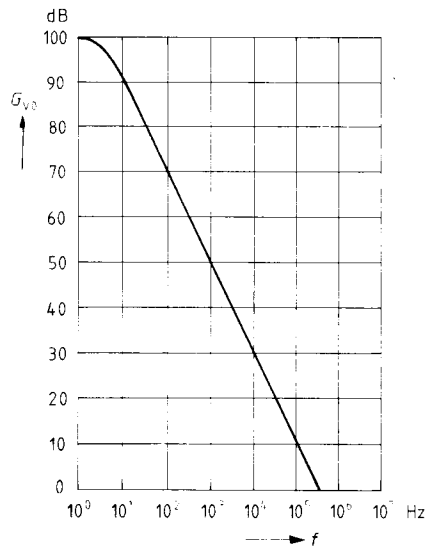

Supply current versus supply voltage

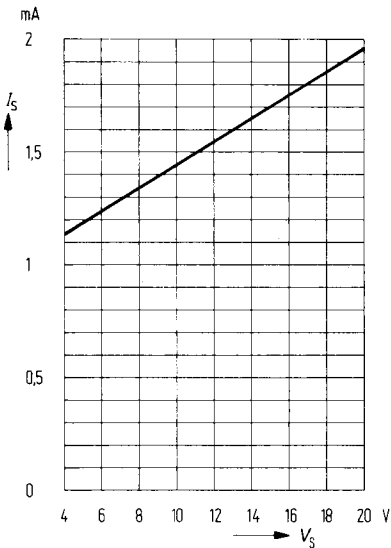

Offset voltage adjustment circuit

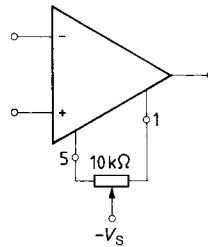

Transient response

