



Micro Commercial Components
 21201 Itasca Street Chatsworth
 CA 91311
 Phone: (818) 701-4933
 Fax: (818) 701-4939

FR3A THRU FR3M

Features

- For Surface Mount Applications
- Extremely Low Thermal Resistance
- Easy Pick And Place
- High Temp Soldering: 250°C for 10 Seconds At Terminals\
- Fast Recovery Times For High Efficiency

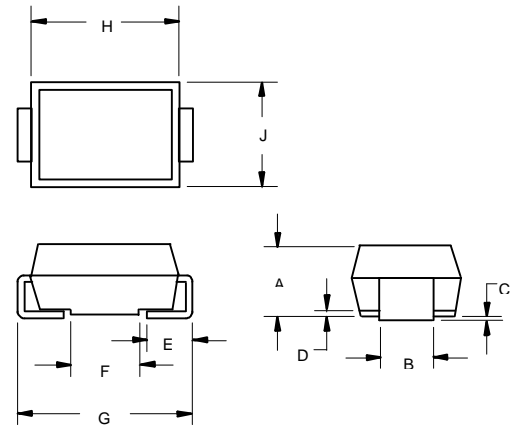
3 Amp Fast Recovery Silicon Rectifier 50 to 1000 Volts

Maximum Ratings

- Operating Temperature: -55°C to +150°C
- Storage Temperature: -55°C to +150°C
- Maximum Thermal Resistance; 10°C/W Junction To Lead

MCC Catalog Number	Device Marking	Maximum Recurrent Peak Reverse Voltage	Maximum RMS Voltage	Maximum DC Blocking Voltage
FR3A	FR3A	50V	35V	50V
FR3B	FR3B	100V	70V	100V
FR3D	FR3D	200V	140V	200V
FR3G	FR3G	400V	280V	400V
FR3J	FR3J	600V	420V	600V
FR3K	FR3K	800V	560V	800V
FR3M	FR3M	1000V	700V	1000V

DO-214AB (SMCJ)



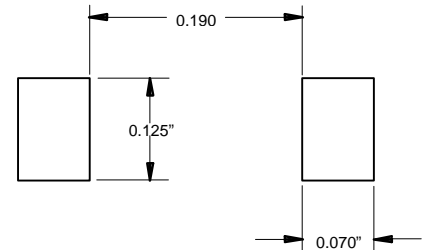
DIMENSIONS

DIM	INCHES		MM		NOTE
	MIN	MAX	MIN	MAX	
A	.079	.103	2.00	2.62	
B	.108	.128	2.75	3.25	
C	.002	.008	.051	.203	
D					
E	.030	.050	.76	1.27	
F					
G	.305	.320	7.75	8.13	
H	.260	.280	6.60	7.11	
J	.220	.245	5.59	6.22	

Electrical Characteristics @ 25°C Unless Otherwise Specified

Average Forward Current	$I_{F(AV)}$	3.0A	$T_J = 120^\circ\text{C}$
Peak Forward Surge Current	I_{FSM}	100A	8.3ms, half sine
Maximum Instantaneous Forward Voltage	V_F	1.30V	$I_{FM} = 3.0A$; $T_J = 25^\circ\text{C}^*$
Maximum DC Reverse Current At Rated DC Blocking Voltage	I_R	10 μ A 250 μ A	$T_J = 25^\circ\text{C}$ $T_J = 100^\circ\text{C}$
Maximum Reverse Recovery Time	T_{rr}	150ns 250ns 500ns	$I_F=0.5A$, $I_R=1.0A$, $I_{rr}=0.25A$
FR3A-G FR3J FR3K-M			
Typical Junction Capacitance	C_J	80pF	Measured at 1.0MHz, $V_R=4.0V$

SUGGESTED SOLDER PAD LAYOUT

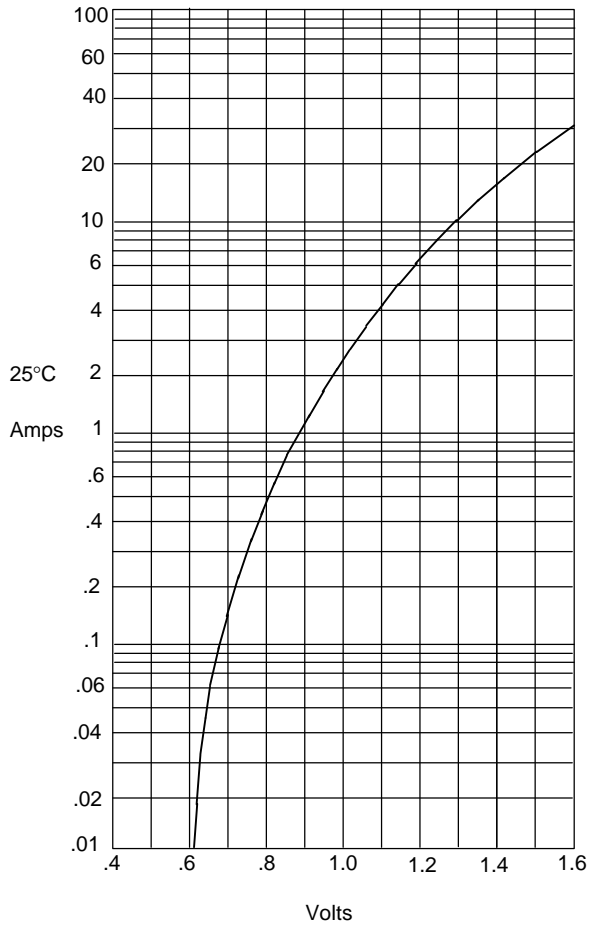


*Pulse test: Pulse width 200 μ sec, Duty cycle 2%

FR3A thru FR3M

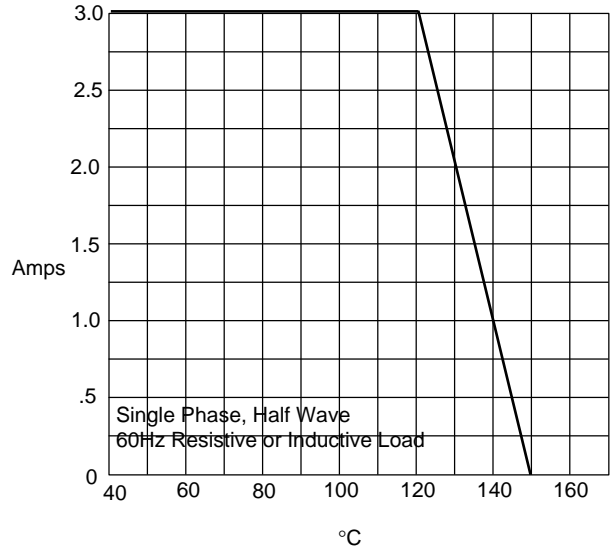


Figure 1
Typical Forward Characteristics



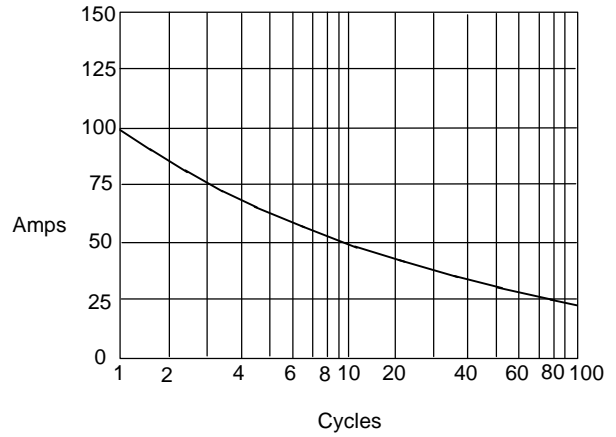
Instantaneous Forward Current - Amperes *versus*
Instantaneous Forward Voltage - Volts

Figure 2
Forward Derating Curve



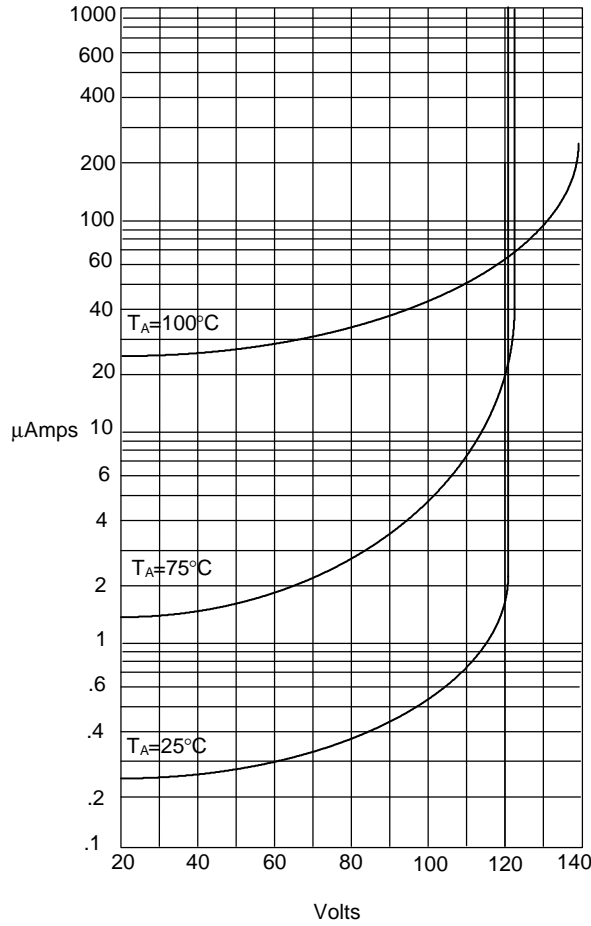
Average Forward Rectified Current - Amperes *versus*
Ambient Temperature - °C

Figure 3
Peak Forward Surge Current



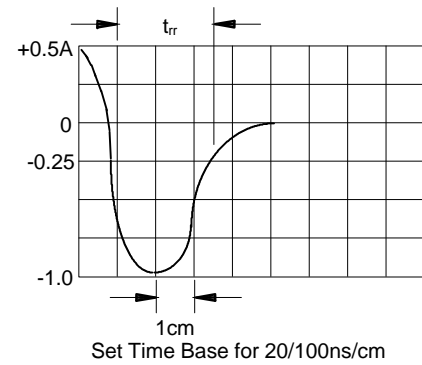
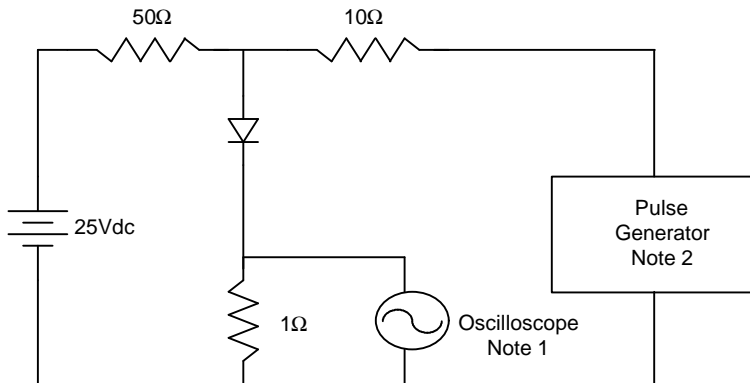
Peak Forward Surge Current - Amperes *versus*
Number Of Cycles At 60Hz - Cycles

Figure 4
Typical Reverse Characteristics



Instantaneous Reverse Leakage Current - MicroAmperes versus Percent Of Rated Peak Reverse Voltage - Volts

Figure 5
Reverse Recovery Time Characteristic And Test Circuit Diagram



- Notes:
1. Rise Time = 7ns max.
Input impedance = 1 megohm, 22pF
 2. Rise Time = 10ns max.
Source impedance = 50 ohms
 3. Resistors are non-inductive