

FEATURES

- Ultralow standby power $I_{DD} = 50$ nA typical
- 256-position
- End-to-end resistance 100 k Ω
- Logic high voltage 1.8 V
- Power supply 2.7 V to 5.5 V
- Low temperature coefficient 35 ppm/ $^{\circ}$ C
- Compact thin 8-lead TSOT-8 (2.9 mm \times 2.8 mm) package
- Simple 3-wire digital interface
- Wide operating temperature -40° C to $+125^{\circ}$ C
- Pin-to-pin compatible to AD5160 with CS inverted

APPLICATIONS

- Battery-operated electronics adjustment
- Remote utilities meter adjustment
- Mechanical potentiometer replacement
- Transducer circuit adjustment
- Automotive electronics adjustment
- Gain control and offset adjustment
- System calibration
- VCXO adjustment

GENERAL OVERVIEW

The AD5165 provides a compact 2.9 mm \times 2.8 mm packaged solution for 256-position adjustment applications. These devices perform the same electronic adjustment function as mechanical potentiometers or variable resistors, with enhanced resolution, solid-state reliability, and superior low temperature coefficient performance. The AD5165's supply voltage requirement is 2.7 V to 5.5 V, but its logic voltage requirement is 1.8 V to V_{DD} . The AD5165 consumes very low quiescent power during standby mode and is ideal for battery-operated applications.

Wiper settings are controlled through a simple 3-wire interface. The interface is similar to the SPI[®] digital interface except for the inverted chip-select function that minimizes logic power consumption in the idling state. The resistance between the wiper and either endpoint of the fixed resistor varies linearly with respect to the digital code transferred into the wiper register.

Operating from a 2.7 V to 5.5 V power supply and consuming less than 50 nA typical standby power allows use in battery-operated portable or remote utility device applications.

Rev. 0

Information furnished by Analog Devices is believed to be accurate and reliable. However, no responsibility is assumed by Analog Devices for its use, nor for any infringements of patents or other rights of third parties that may result from its use. Specifications subject to change without notice. No license is granted by implication or otherwise under any patent or patent rights of Analog Devices. Trademarks and registered trademarks are the property of their respective owners.

FUNCTIONAL BLOCK DIAGRAM

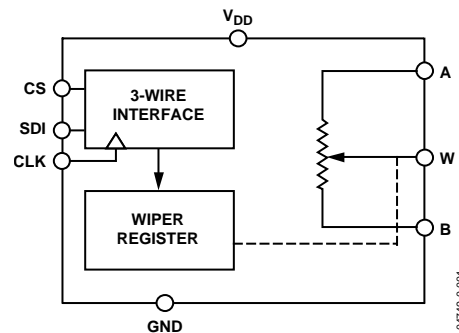

Figure 1.

PIN CONFIGURATION

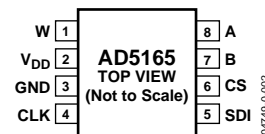

Figure 2.

TYPICAL APPLICATION

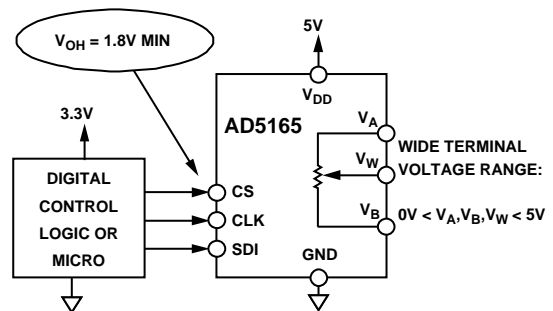

Figure 3.

Note:

The terms *digital potentiometer*, *RDAC*, and *VR* are used interchangeably.

TABLE OF CONTENTS

Electrical Characteristics—100 k Ω Version	3	3-Wire Serial Bus Digital Interface	14
Absolute Maximum Ratings.....	5	ESD Protection	14
Pin Configuration and Functional Descriptions.....	6	Terminal Voltage Operating Range.....	14
Typical Performance Characteristics	7	Power-Up Sequence	14
Test Circuits.....	11	Layout and Power Supply Bypassing	15
3-Wire Digital Interface.....	12	Evaluation Board.....	15
Theory of Operation	13	Outline Dimensions	16
Programming the Variable Resistor	13	Ordering Guide	16
Programming the Potentiometer Divider	14		

REVISION HISTORY

4/04—Revision 0: Initial Version

ELECTRICAL CHARACTERISTICS—100 kΩ VERSION

$V_{DD} = 5\text{ V} \pm 10\%$, or $3\text{ V} \pm 10\%$; $V_A = V_{DD}$; $V_B = 0\text{ V}$; $-40^\circ\text{C} < T_A < +125^\circ\text{C}$; unless otherwise noted.

Table 1.

Parameter	Symbol	Conditions	Min	Typ ¹	Max	Unit
DC CHARACTERISTICS—RHEOSTAT MODE						
Resistor Differential Nonlinearity ²	R-DNL	R_{WB} , $V_A = \text{no connect}$	-1	±0.1	+1	LSB
Resistor Integral Nonlinearity ²	R-INL	R_{WB} , $V_A = \text{no connect}$	-2	±0.25	+2	LSB
Nominal Resistor Tolerance ³	$\Delta R_{AB}/R_{AB}$	$T_A = 25^\circ\text{C}$	-20		+20	%
Resistance Temperature Coefficient	$(\Delta R_{AB}/R_{AB})/\Delta T \times 10^6$	$V_{AB} = V_{DD}$, wiper = no connect		35		ppm/°C
Wiper Resistance	R_W	$V_{DD} = 2.7\text{ V}/5.5\text{ V}$		85/50	150/120	Ω
DC CHARACTERISTICS—POTENTIOMETER DIVIDER MODE						
Resolution	N				8	Bits
Differential Nonlinearity ⁴	DNL		-1	±0.1	+1	LSB
Integral Nonlinearity ⁴	INL		-1	±0.3	+1	LSB
Voltage Divider Temperature Coefficient	$(\Delta V_W/V_W)/\Delta T \times 10^6$	Code = 0x80		15		ppm/°C
Full-Scale Error	V_{WFSE}	Code = 0xFF	-0.5	-0.3	0	LSB
Zero-Scale Error	V_{WZSE}	Code = 0x00	0	0.1	0.5	LSB
RESISTOR TERMINALS						
Voltage Range ⁵	$V_{A,B,W}$		GND		V_{DD}	V
Capacitance ⁶ A, B	$C_{A,B}$	$f = 1\text{ MHz}$, measured to GND, Code = 0x80		90		pF
Capacitance ⁶ W	C_W	$f = 1\text{ MHz}$, measured to GND, Code = 0x80		95		pF
Common-Mode Leakage	I_{CM}	$V_A = V_B = V_{DD}/2$		1		nA
DIGITAL INPUTS AND OUTPUTS						
Input Logic High	V_{IH}	$V_{DD} = 2.7\text{ V to }5.5\text{ V}$	1.8			V
Input Logic Low	V_{IL}	$V_{DD} = 2.7\text{ V to }5.5\text{ V}$			0.6	V
Input Capacitance ⁶	C_{IL}			5		pF
POWER SUPPLIES						
Power Supply Range	$V_{DD\text{ RANGE}}$		2.7		5.5	V
Supply Current	I_{DD}	Digital inputs = 0 V or V_{DD} $V_{DD} = 2.7\text{ V}$, digital inputs = 1.8 V $V_{DD} = 5\text{ V}$, digital inputs = 1.8 V		0.05 10 500	1	μA μA μA
Power Dissipation ⁷	P_{DISS}	Digital inputs = 0 V or V_{DD}			5.5	μW
Power Supply Sensitivity	PSS	$V_{DD} = +5\text{ V} \pm 10\%$, Code = Midscale		±0.001	±0.005	%/%
DYNAMIC CHARACTERISTICS^{6,8}						
Bandwidth -3 dB	BW	Code = 0x80		55		kHz
Total Harmonic Distortion	THD _W	$V_A = 1\text{ V rms}$, $V_B = 0\text{ V}$, $f = 1\text{ kHz}$,		0.05		%
V_W Settling Time	t_S	$V_A = 5\text{ V}$, $V_B = 0\text{ V}$, ±1 LSB error band		2		μs
Resistor Noise Voltage Density	e_{N_WB}	$R_{WB} = 50\text{ k}\Omega$		28		nV/√Hz

¹ Typical specifications represent average readings at +25°C and $V_{DD} = 5\text{ V}$.

² Resistor position nonlinearity error R-INL is the deviation from an ideal value measured between the maximum resistance and the minimum resistance wiper positions. R-DNL measures the relative step change from ideal between successive tap positions. Parts are guaranteed monotonic.

³ $V_{AB} = V_{DD}$, wiper (V_W) = no connect.

⁴ INL and DNL are measured at V_W with the RDAC configured as a potentiometer divider similar to a voltage output D/A converter. $V_A = V_{DD}$ and $V_B = 0\text{ V}$.

⁵ Resistor terminals A, B, and W have no limitations on polarity with respect to each other.

⁶ Guaranteed by design and not subject to production test.

⁷ P_{DISS} is calculated from $(I_{DD} \times V_{DD})$. CMOS logic level inputs result in minimum power dissipation.

⁸ All dynamic characteristics use $V_{DD} = 5\text{ V}$.

TIMING CHARACTERISTICS—100 k Ω VERSION

$V_{DD} = +5\text{ V} \pm 10\%$, or $+3\text{ V} \pm 10\%$; $V_A = V_{DD}$; $V_B = 0\text{ V}$; $-40^\circ\text{C} < T_A < +125^\circ\text{C}$; unless otherwise noted.

Table 2.

Parameter	Symbol	Conditions	Min	Typ ¹	Max	Unit
3-WIRE INTERFACE TIMING CHARACTERISTICS ^{2,3,4} (specifications apply to all parts)						
Clock Frequency	$f_{CLK} = 1/(t_{CH} + t_{CL})$	Clock level high or low			25	MHz
Input Clock Pulse Width	t_{CH}, t_{CL}		20			ns
Data Setup Time	t_{DS}		5			ns
Data Hold Time	t_{DH}		5			ns
CS Setup Time	t_{CSS}		15			ns
CS Low Pulse Width	t_{CSW}		40			ns
CLK Fall to CS Rise Hold Time	t_{CSH0}		0			ns
CLK Fall to CS Fall Hold Time	t_{CSH1}		0			ns
CS Fall to Clock Rise Setup	t_{CS1}		10			ns

¹ Typical specifications represent average readings at $+25^\circ\text{C}$ and $V_{DD} = 5\text{ V}$.

² Guaranteed by design and not subject to production test.

³ All dynamic characteristics use $V_{DD} = 5\text{ V}$.

⁴ See Figure 34 and Figure 35 for location of measured values. All input control voltages are specified with $t_R = t_F = 2\text{ ns}$ (10% to 90% of 3 V) and timed from a voltage level of 1.5 V.

ABSOLUTE MAXIMUM RATINGS

$T_A = +25^\circ\text{C}$, unless otherwise noted.^{1,2}

Table 3.

Parameter	Value
V_{DD} to GND	-0.3 V to +7 V
V_A , V_B , V_W to GND	V_{DD}
Maximum Current	
I_{WB} , I_{WA} Pulsed	± 20 mA
I_{WB} Continuous ($R_{WB} \leq 1$ k Ω , A open) ²	± 5 mA
I_{WA} Continuous ($R_{WA} \leq 1$ k Ω , B open) ²	± 5 mA
Digital Inputs and Output Voltage to GND	0 V to +7 V
Operating Temperature Range	-40°C to +125°C
Maximum Junction Temperature (T_{JMAX})	150°C
Storage Temperature	-65°C to +150°C
Lead Temperature (Soldering, 10 – 30 sec)	245°C
Thermal Resistance ² θ_{JA} : TSOT-8	200°C/W

¹ Maximum terminal current is bounded by the maximum current handling of the switches, maximum power dissipation of the package, and maximum applied voltage across any two of the A, B, and W terminals at a given resistance.

² Package power dissipation = $(T_{JMAX} - T_A)/\theta_{JA}$.

Stresses above those listed under Absolute Maximum Ratings may cause permanent damage to the device. This is a stress rating only; functional operation of the device at these or any other conditions above those indicated in the operational section of this specification is not implied. Exposure to absolute maximum rating conditions for extended periods may affect device reliability.

ESD CAUTION

ESD (electrostatic discharge) sensitive device. Electrostatic charges as high as 4000 V readily accumulate on the human body and test equipment and can discharge without detection. Although this product features proprietary ESD protection circuitry, permanent damage may occur on devices subjected to high energy electrostatic discharges. Therefore, proper ESD precautions are recommended to avoid performance degradation or loss of functionality.



AD5165

PIN CONFIGURATION AND FUNCTIONAL DESCRIPTIONS

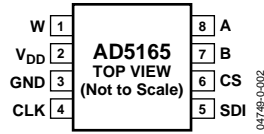

Figure 4.

Table 4.

Pin	Name	Description
1	W	Wiper terminal. $GND \leq V_A \leq V_{DD}$.
2	V_{DD}	Positive Power Supply.
3	GND	Digital Ground.
4	CLK	Serial Clock Input. Positive-edge triggered.
5	SDI	Serial Data Input (data loads MSB first).
6	CS	Chip Select Input, active high. When CS returns low, data is loaded into the wiper register.
7	B	B terminal. $GND \leq V_A \leq V_{DD}$.
8	A	A terminal. $GND \leq V_A \leq V_{DD}$.

TYPICAL PERFORMANCE CHARACTERISTICS

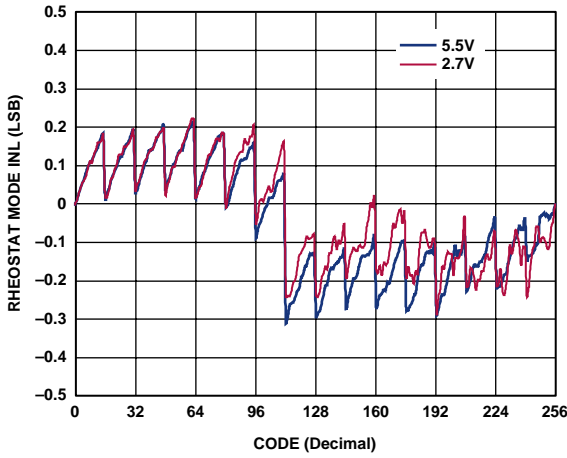

Figure 5. R-INL vs. Code vs. Supply Voltages

04789-0-011

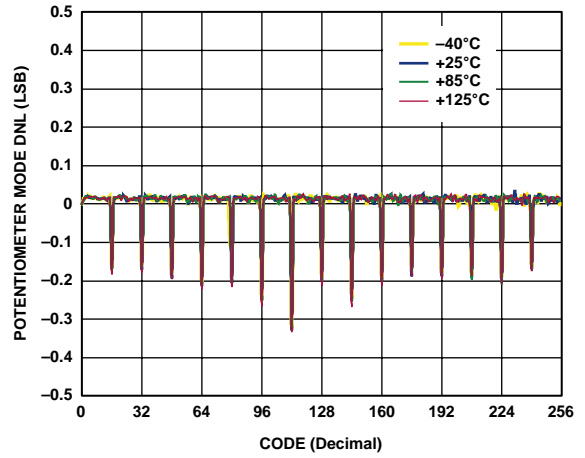

Figure 8. DNL vs. Code vs. Temperature, $V_{DD} = 5 V$

04789-0-008

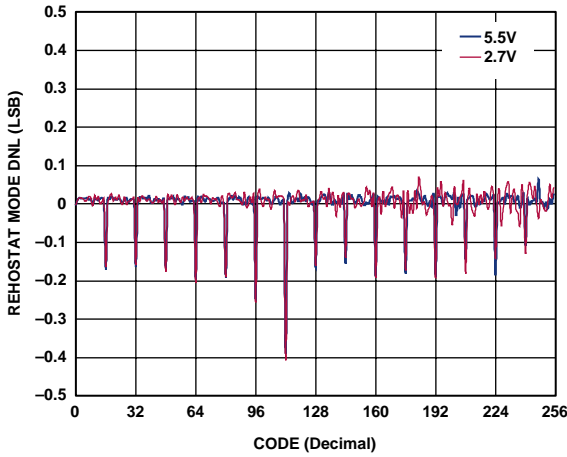

Figure 6. R-DNL vs. Code vs. Supply Voltages

04789-0-013

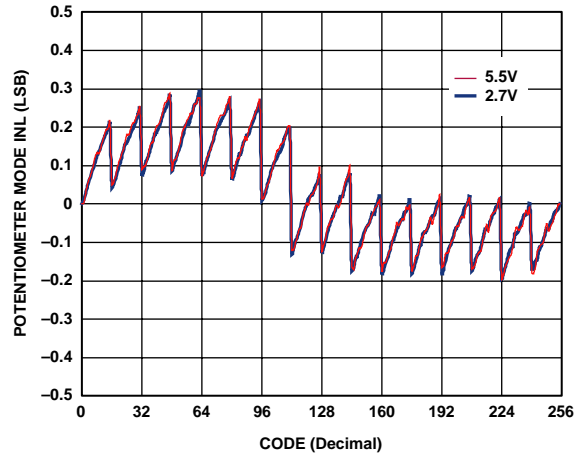

Figure 9. INL vs. Code vs. Supply Voltages

04789-0-007

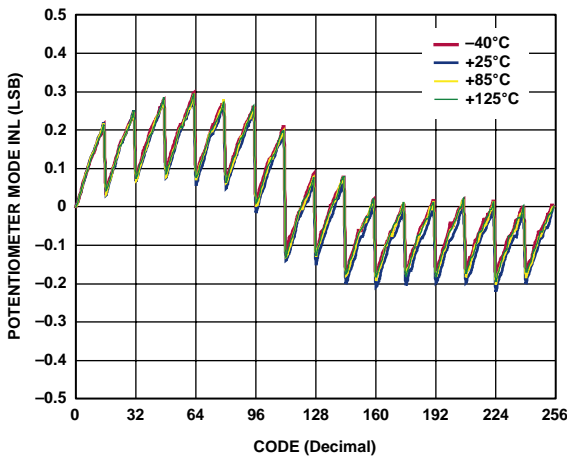

Figure 7. INL vs. Code vs. Temperature, $V_{DD} = 5 V$

04789-0-006

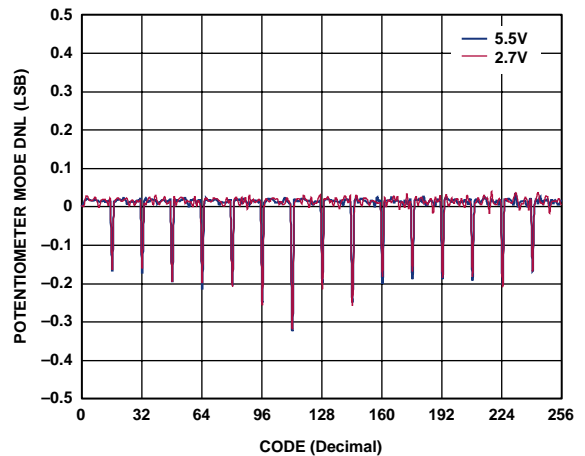

Figure 10. DNL vs. Code vs. Supply Voltages

04789-0-009

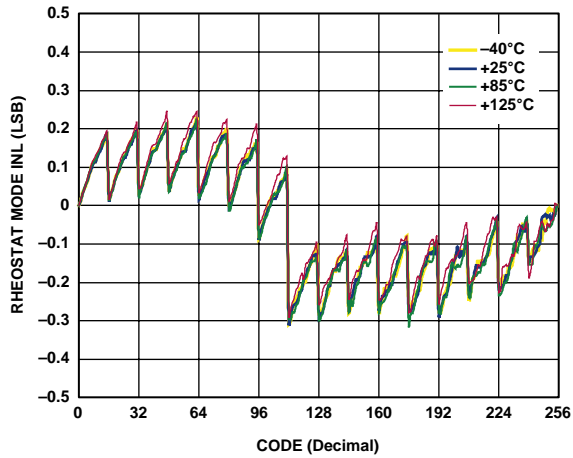

Figure 11. R-INL vs. Code vs. Temperature, $V_{DD} = 5V$

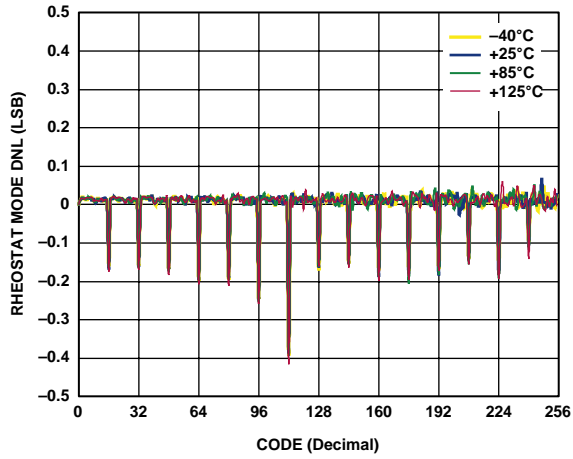

Figure 12. R-DNL vs. Code vs. Temperature, $V_{DD} = 5V$

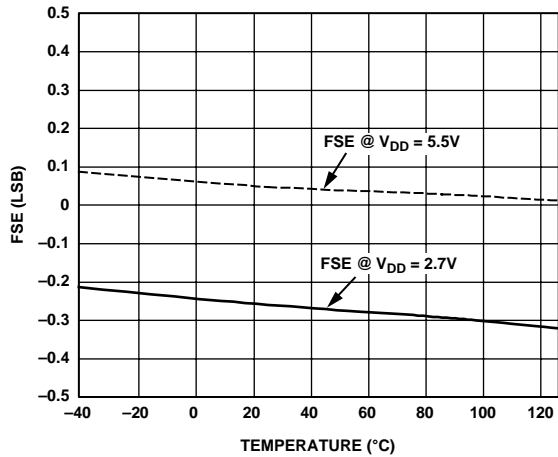

Figure 13. Full-Scale Error vs. Temperature

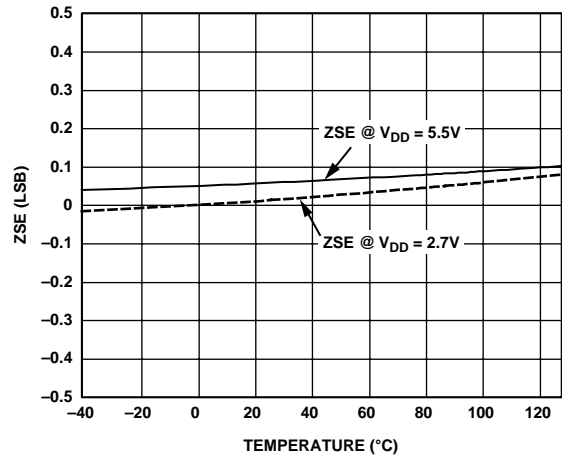

Figure 14. Zero-Scale Error vs. Temperature

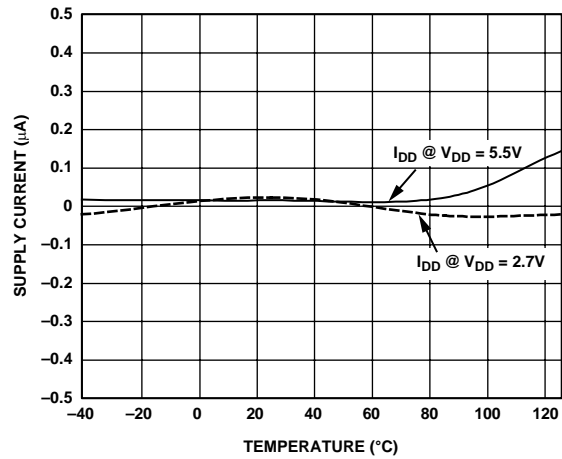

Figure 15. Supply Current vs. Temperature

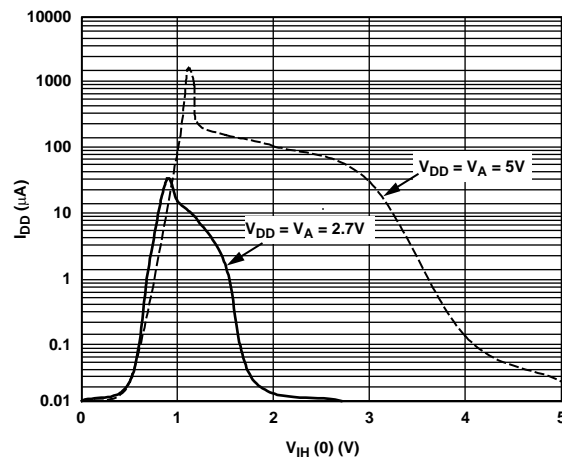

Figure 16. Supply Current vs. Digital Input Voltage

04749-0-010

04749-0-022

04749-0-012

04749-0-020

04749-0-023

04749-0-025

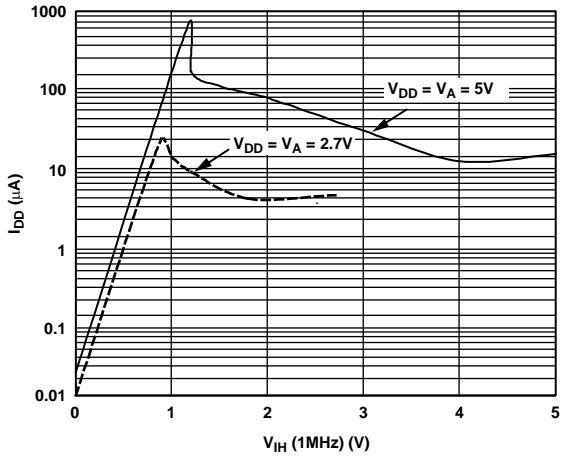

Figure 17. Supply Current vs. Digital Input Voltage

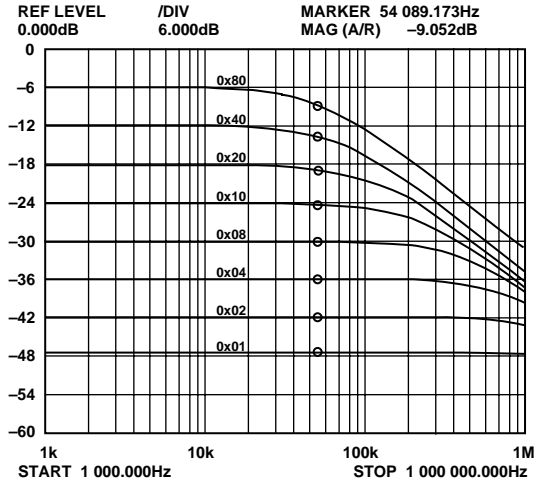

Figure 20. Gain vs. Frequency vs. Code, $R_{AB} = 100\text{ k}\Omega$

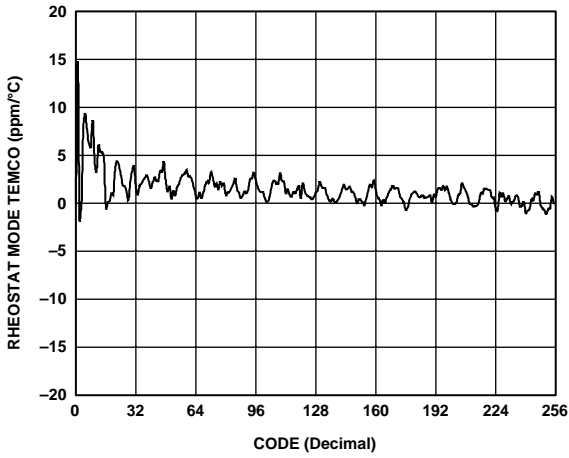

Figure 18. Rheostat Mode Tempco $\Delta R_{WB}/\Delta T$ vs. Code

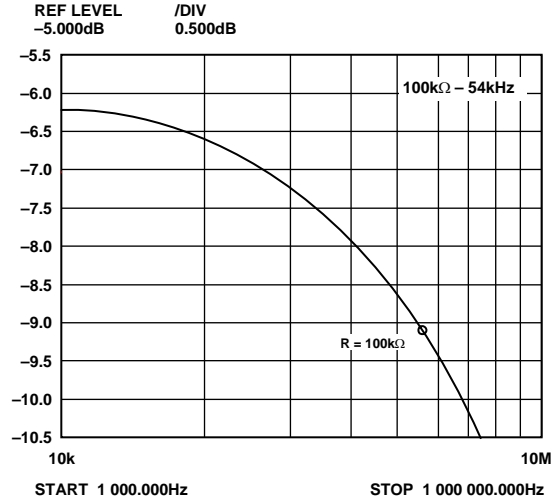

Figure 21. -3 dB Bandwidth @ Code = 0x80

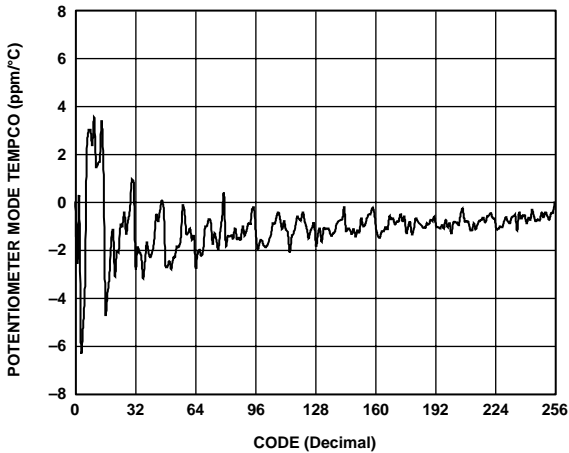

Figure 19. Potentiometer Mode Tempco $\Delta V_{WB}/\Delta T$ vs. Code

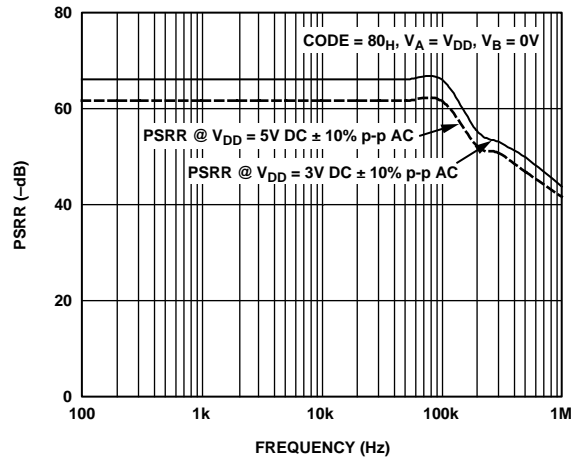

Figure 22. PSRR vs. Frequency

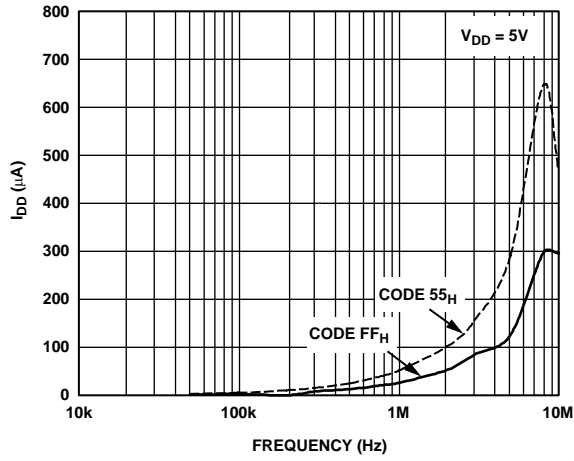

Figure 23. I_{DD} vs. Frequency

04749-0-018

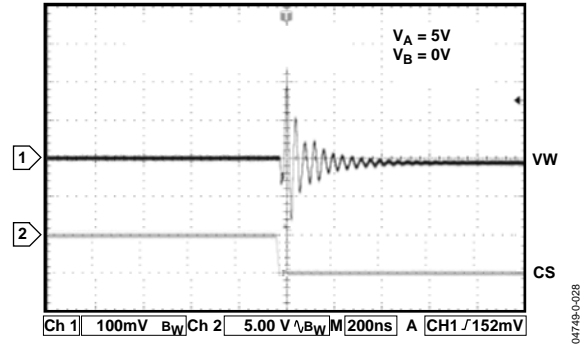

Figure 26. Midscale Glitch, Code 0x80–0x7F

04749-0-028

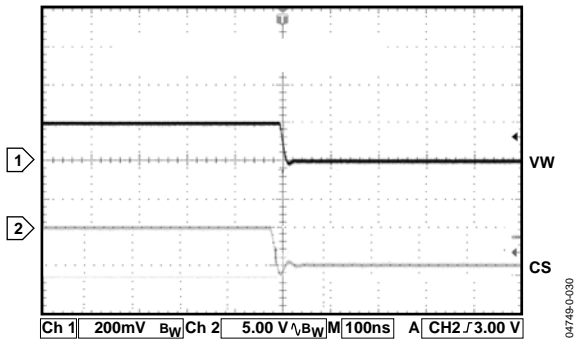

Figure 24. Large Signal Settling Time, Code 0xFF–0x00

04749-0-030

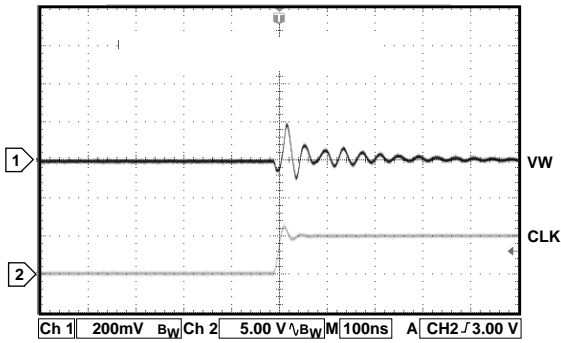

Figure 25. Digital Feedthrough

04749-0-030

TEST CIRCUITS

Figure 27 to Figure 33 illustrate the test circuits that define the test conditions used in the product specification tables.

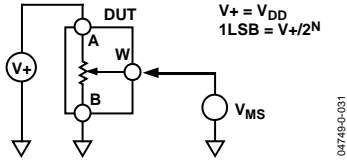

Figure 27. Test Circuit for Potentiometer Divider Nonlinearity Error (INL, DNL)

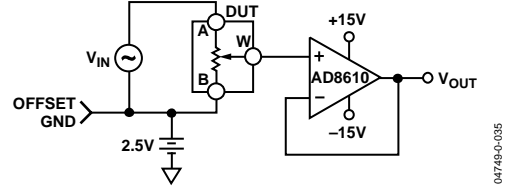

Figure 31. Test Circuit for Gain vs. Frequency

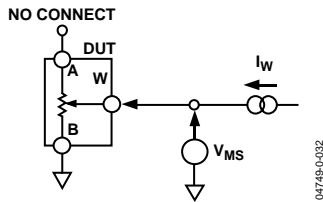

Figure 28. Test Circuit for Resistor Position Nonlinearity Error (Rheostat Operation; R-INL, R-DNL)

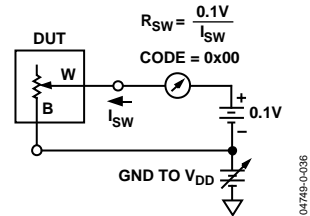

Figure 32. Test Circuit for Incremental ON Resistance

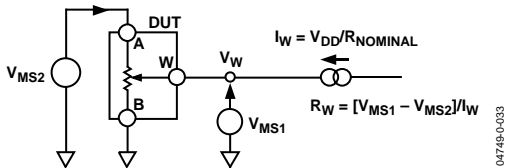

Figure 29. Test Circuit for Wiper Resistance

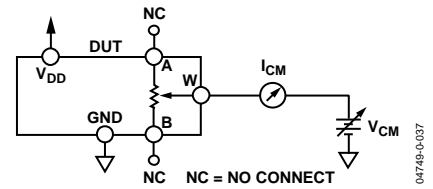

Figure 33. Test Circuit for Common-Mode Leakage Current

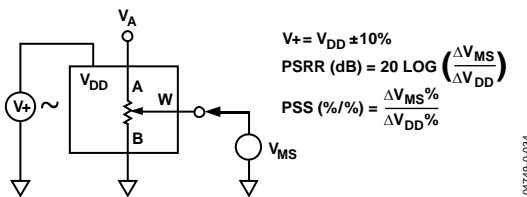

Figure 30. Test Circuit for Power Supply Sensitivity (PSS, PSRR)

AD5165

3-WIRE DIGITAL INTERFACE

Note that in the AD5165 data is loaded MSB first.

Table 5. AD5165 Serial Data-Word Format

B7	B6	B5	B4	B3	B2	B1	B0
D7	D6	D5	D4	D3	D2	D1	D0
MSB							LSB
2^7							2^0

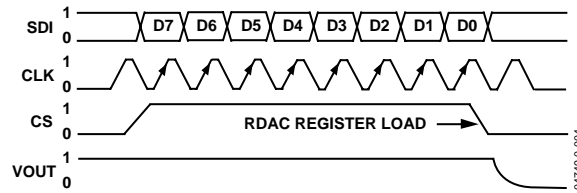

Figure 34. 3-Wire Digital Interface Timing Diagram
($V_A = 5\text{ V}$, $V_B = 0\text{ V}$, $V_W = V_{OUT}$)

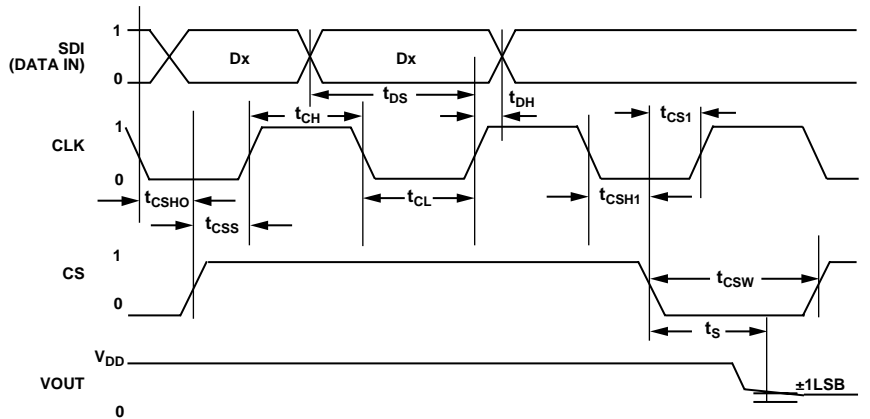

Figure 35. 3-Wire Digital Interface Detailed Timing Diagram ($V_A = 5\text{ V}$, $V_B = 0\text{ V}$, $V_W = V_{OUT}$)

THEORY OF OPERATION

The AD5165 is a 256-position digitally controlled variable resistor (VR) device.

PROGRAMMING THE VARIABLE RESISTOR

Rheostat Operation

The nominal resistance of the RDAC between terminals A and B is available in 100 kΩ. The nominal resistance (R_{AB}) of the VR has 256 contact points accessed by the wiper terminal, plus the B terminal contact. The 8-bit data in the RDAC latch is decoded to select one of the 256 possible settings.

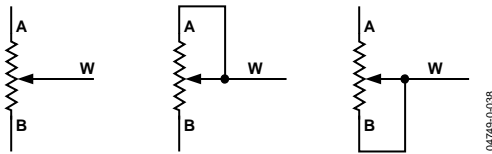

Figure 36. Rheostat Mode Configuration

Assuming that a 100 kΩ part is used, the wiper’s first connection starts at the B terminal for data 0x00. Because there is a 50 Ω wiper contact resistance, such a connection yields a minimum of 100 Ω ($2 \times 50 \Omega$) resistance between terminals W and B. The second connection is the first tap point, which corresponds to 490 Ω ($R_{WB} = R_{AB}/256 + 2 \times R_W = 390 \Omega + 2 \times 50 \Omega$) for data 0x01. The third connection is the next tap point, representing 880 Ω ($2 \times 390 \Omega + 2 \times 50 \Omega$) for data 0x02, and so on. Each LSB data value increase moves the wiper up the resistor ladder until the last tap point is reached at 100,100 Ω ($R_{AB} + 2 \times R_W$).

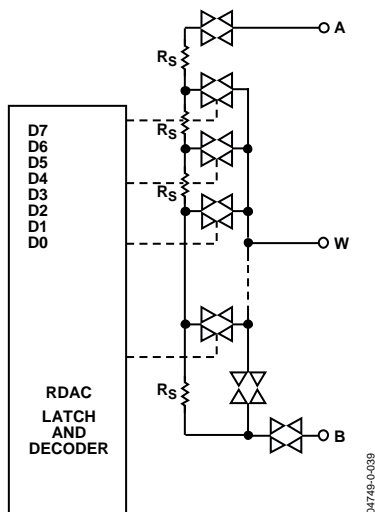

Figure 37. AD5165 Equivalent RDAC Circuit

The general equation determining the digitally programmed output resistance between W and B is

$$R_{WB}(D) = \frac{D}{256} \times R_{AB} + 2 \times R_W \tag{1}$$

where:

- D is the decimal equivalent of the binary code loaded in the 8-bit RDAC register.
- R_{AB} is the end-to-end resistance.
- R_W is the wiper resistance contributed by the on resistance of the internal switch.

In summary, if $R_{AB} = 100 \text{ k}\Omega$ and the A terminal is open circuited, the following output resistance R_{WB} is set for the indicated RDAC latch codes.

Table 6. Codes and Corresponding R_{WB} Resistance

D (Dec.)	R_{WB} (Ω)	Output State
255	99,710	Full scale ($R_{AB} - 1 \text{ LSB} + R_W$)
128	50,100	Midscale
1	490	1 LSB
0	100	Zero scale (wiper contact resistance)

Note that, in the zero-scale condition, a finite wiper resistance of 100 Ω is present. Care should be taken to limit the current flow between W and B in this state to a maximum pulse current of no more than 20 mA. Otherwise, degradation or possible destruction of the internal switch contact can occur.

Similar to the mechanical potentiometer, the resistance of the RDAC between the wiper W and terminal A also produces a digitally controlled complementary resistance, R_{WA} . When these terminals are used, the B terminal can be opened. Setting the resistance value for R_{WA} starts at a maximum value of resistance and decreases as the data loaded in the latch increases in value. The general equation for this operation is

$$R_{WA}(D) = \frac{256 - D}{256} \times R_{AB} + 2 \times R_W \tag{2}$$

For $R_{AB} = 100 \text{ k}\Omega$ with the B terminal open circuited, the following output resistance R_{WA} is set for the indicated RDAC latch codes.

Table 7. Codes and Corresponding R_{WA} Resistance

D (Dec.)	R_{WA} (Ω)	Output State
255	490	Full scale
128	50,100	Midscale
1	99,710	1 LSB
0	100,100	Zero scale

Typical device-to-device matching is process-lot dependent and may vary by up to $\pm 20\%$. Because the resistance element is processed in thin film technology, the change in R_{AB} with temperature has a very low 35 ppm/°C temperature coefficient.

PROGRAMMING THE POTENTIOMETER DIVIDER

Voltage Output Operation

The digital potentiometer easily generates a voltage divider at wiper-to-B and wiper-to-A proportional to the input voltage at A to B. Unlike the polarity of V_{DD} to GND, which must be positive, voltage across A to B, W to A, and W to B can be at either polarity.

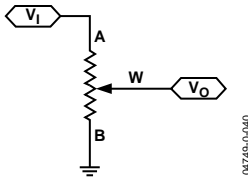

Figure 38. Potentiometer Mode Configuration

If ignoring the effect of the wiper resistance for approximation, connecting the A terminal to 5 V and the B terminal to ground produces an output voltage at the wiper-to-B starting at 0 V up to 1 LSB less than 5 V. Each LSB of voltage is equal to the voltage applied across terminals A and B divided by the 256 positions of the potentiometer divider. The general equation defining the output voltage at V_W with respect to ground for any valid input voltage applied to terminals A and B is

$$V_W(D) = \frac{D}{256}V_A + \frac{256-D}{256}V_B \quad (3)$$

A more accurate calculation, which includes the effect of wiper resistance, V_W , is

$$V_W(D) = \frac{R_{WB}(D)}{R_{AB}}V_A + \frac{R_{WA}(D)}{R_{AB}}V_B \quad (4)$$

Operation of the digital potentiometer in the divider mode results in a more accurate operation over temperature. Unlike the rheostat mode, the output voltage is dependent mainly on the ratio of the internal resistors R_{WA} and R_{WB} and not the absolute values. Therefore, the temperature drift reduces to 15 ppm/°C.

3-WIRE SERIAL BUS DIGITAL INTERFACE

The AD5165 contains a 3-wire digital interface (SDI, CS, and CLK). The 8-bit serial word must be loaded MSB first. The format of the word is shown in Table 5.

The positive-edge sensitive CLK input requires clean transitions to avoid clocking incorrect data into the serial input register. Standard logic families work well. If mechanical switches are used for product evaluation, they should be debounced by a flip-flop or other suitable means. When CS is high, the clock loads data into the serial register on each positive clock edge, as shown in Figure 34.

The data setup and data hold times in the specifications table determine the valid timing requirements. The AD5165 uses an 8-bit serial input data register word that is transferred to the internal RDAC register when the CS line returns to logic low. Extra MSB bits are ignored.

ESD PROTECTION

All digital inputs are protected with a series of input resistors and parallel Zener ESD structures, shown in Figure 39 and Figure 40. This applies to the digital input pins SDI, CLK, and CS.

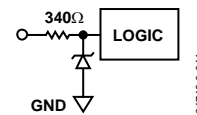

Figure 39. ESD Protection of Digital Pins

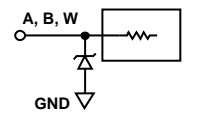

Figure 40. ESD Protection of Resistor Terminals

TERMINAL VOLTAGE OPERATING RANGE

The AD5165 V_{DD} and GND power supply defines the boundary conditions for proper 3-terminal digital potentiometer operation. Supply signals present on terminals A, B, and W that exceed V_{DD} or GND are clamped by the internal forward-biased diodes, as shown in Figure 41.

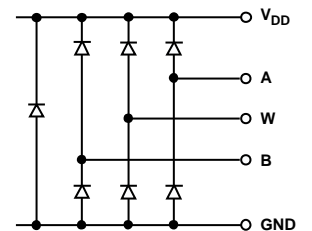

Figure 41. Maximum Terminal Voltages Set by V_{DD} and GND

POWER-UP SEQUENCE

Because the ESD protection diodes limit the voltage compliance at terminals A, B, and W (see Figure 41), it is important to power V_{DD}/GND before applying any voltage to terminals A, B, and W; otherwise, the diode is forward biased such that V_{DD} is powered unintentionally and may affect the rest of the user's circuit. The ideal power-up sequence is in the following order: GND, V_{DD} , digital inputs, and then V_A , V_B , and V_W . The relative order of powering V_A , V_B , V_W , and the digital inputs is not important as long as they are powered after V_{DD}/GND .

LAYOUT AND POWER SUPPLY BYPASSING

It is good practice to employ compact, minimum lead length layout design. The leads to the inputs should be as direct as possible with a minimum conductor length. Ground paths should have low resistance and low inductance.

Similarly, it is also good practice to bypass the power supplies with quality capacitors for optimum stability. Supply leads to the device should be bypassed with disk or chip ceramic capacitors of 0.01 μF to 0.1 μF . Low ESR 1 μF to 10 μF tantalum or electrolytic capacitors should also be applied at the supplies to minimize any transient disturbance and low frequency ripple (see Figure 42). Note that the digital ground should also be joined remotely to the analog ground at one point to minimize the ground bounce.

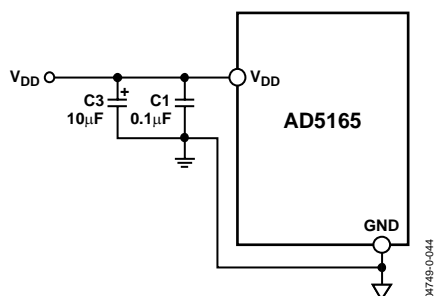

Figure 42. Power Supply Bypassing

EVALUATION BOARD

An evaluation board, along with all necessary software, is available to program the AD5165 from any PC running Windows® 98/2000/XP. The graphical user interface, as shown in Figure 43, is straightforward and easy to use. More detailed information is available in the user manual, which comes with the board.

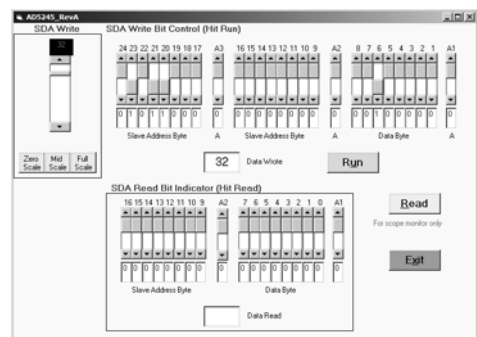

Figure 43. AD5165 Evaluation Board Software

The AD5165 starts at midscale upon power-up. To increment or decrement the resistance, the user may move the scroll bars on the left. To write any specific value, the user should use the bit pattern in the upper screen and click the Run button. The format of writing data to the device is shown in Figure 32.

OUTLINE DIMENSIONS

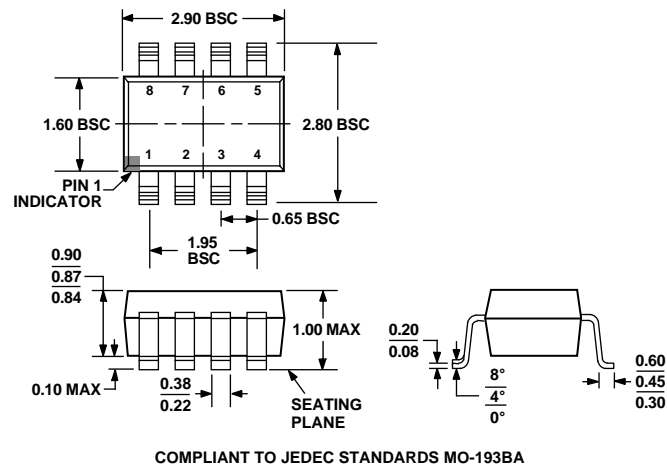

Figure 44. 8-Lead Thin Small Outline Transistor Package [Thin SOT-23] (UJ-8)
Dimensions shown in millimeters

ORDERING GUIDE

Model	R _{AB} (Ω)	Temperature	Package Description	Package Option	Quantity on Reel	Branding
AD5165BUJZ100-R2 ¹	100 k	-40°C to +125°C	Thin SOT-23	UJ-8	250	D3N
AD5165BUJZ100-R7 ¹	100 k	-40°C to +125°C	Thin SOT-23	UJ-8	3,000	D3N
AD5165EVAL			Evaluation Board			

¹ Z = Pb-free part.