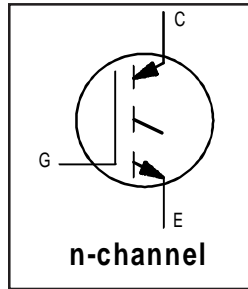


**Features**

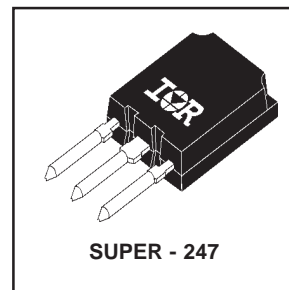
- Hole-less clip/pressure mount package compatible with TO-247 and TO-264, with reinforced pins
- High short circuit rating IGBTs, optimized for motorcontrol
- Minimum switching losses combined with low conduction losses
- Tightest parameter distribution
- Creepage distance increased to 5.35mm



$V_{CES} = 600V$   
 $V_{CE(on) typ.} = 1.83V$   
@  $V_{GE} = 15V, I_C = 60A$

**Benefits**

- Highest current rating IGBT
- Maximum power density, twice the power handling of the TO-247, less space than TO-264



**Absolute Maximum Ratings**

	Parameter	Max.	Units
$V_{CES}$	Collector-to-Emitter Breakdown Voltage	600	V
$I_C @ T_C = 25^\circ C$	Continuous Collector Current	85 ⑥	A
$I_C @ T_C = 100^\circ C$	Continuous Collector Current	60	
$I_{CM}$	Pulsed Collector Current ①	200	
$I_{LM}$	Clamped Inductive Load Current ②	200	
$t_{SC}$	Short Circuit Withstand Time	10	$\mu s$
$V_{GE}$	Gate-to-Emitter Voltage	$\pm 20$	V
$E_{ARV}$	Reverse Voltage Avalanche Energy ③	180	mJ
$P_D @ T_C = 25^\circ C$	Maximum Power Dissipation	350	W
$P_D @ T_C = 100^\circ C$	Maximum Power Dissipation	140	
$T_J$	Operating Junction and	-55 to + 150	$^\circ C$
$T_{STG}$	Storage Temperature Range		
	Soldering Temperature, for 10 seconds	300 (0.063 in. (1.6mm from case )	

**Thermal Resistance\ Mechanical**

	Parameter	Min.	Typ.	Max.	Units
$R_{\theta JC}$	Junction-to-Case	—	—	0.36	$^\circ C/W$
$R_{\theta CS}$	Case-to-Sink, flat, greased surface	—	0.24	—	
$R_{\theta JA}$	Junction-to-Ambient, typical socket mount	—	—	38	
	Recommended Clip Force	20.0(2.0)	—	—	N (kgf)
	Weight	—	6 (0.21)	—	g (oz)

**Electrical Characteristics @ T<sub>J</sub> = 25°C (unless otherwise specified)**

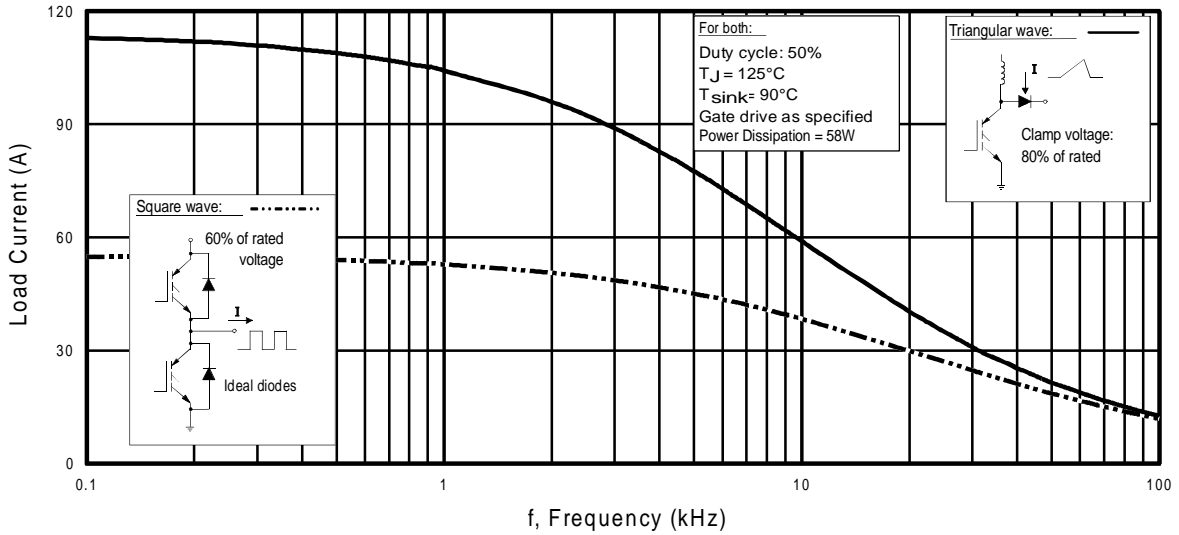
	Parameter	Min.	Typ.	Max.	Units	Conditions
V <sub>(BR)CES</sub>	Collector-to-Emitter Breakdown Voltage	600	—	—	V	V <sub>GE</sub> = 0V, I <sub>C</sub> = 250μA
V <sub>(BR)ECS</sub>	Emitter-to-Collector Breakdown Voltage ④	18	—	—	V	V <sub>GE</sub> = 0V, I <sub>C</sub> = 1.0A
ΔV <sub>(BR)CES/ΔT<sub>J</sub></sub>	Temperature Coeff. of Breakdown Voltage	—	0.5	—	V/°C	V <sub>GE</sub> = 0V, I <sub>C</sub> = 10mA
V <sub>CE(ON)</sub>	Collector-to-Emitter Saturation Voltage	—	1.83	2.3	V	I <sub>C</sub> = 60A I <sub>C</sub> = 100A I <sub>C</sub> = 60A, T <sub>J</sub> = 150°C V <sub>CE</sub> = V <sub>GE</sub> , I <sub>C</sub> = 250μA V <sub>GE</sub> = 15V See Fig.2, 5
		—	2.20	—		
		—	1.81	—		
V <sub>GE(th)</sub>	Gate Threshold Voltage	3.0	—	6.0	mV/°C	V <sub>CE</sub> = V <sub>GE</sub> , I <sub>C</sub> = 1.5mA
ΔV <sub>GE(th)/ΔT<sub>J</sub></sub>	Temperature Coeff. of Threshold Voltage	—	-8.0	—	mV/°C	V <sub>CE</sub> = V <sub>GE</sub> , I <sub>C</sub> = 1.5mA
g <sub>fe</sub>	Forward Transconductance ⑤	31	46	—	S	V <sub>CE</sub> = 50V, I <sub>C</sub> = 60A
I <sub>CES</sub>	Zero Gate Voltage Collector Current	—	—	500	μA	V <sub>GE</sub> = 0V, V <sub>CE</sub> = 600V V <sub>GE</sub> = 0V, V <sub>CE</sub> = 10V, T <sub>J</sub> = 25°C
		—	—	2.0		
		—	—	5.0	mA	V <sub>GE</sub> = 0V, V <sub>CE</sub> = 600V, T <sub>J</sub> = 150°C
I <sub>GES</sub>	Gate-to-Emitter Leakage Current	—	—	±100	nA	V <sub>GE</sub> = ±20V

**Switching Characteristics @ T<sub>J</sub> = 25°C (unless otherwise specified)**

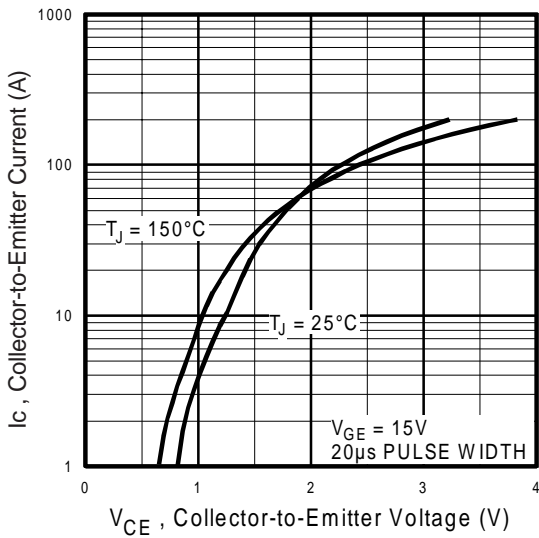
	Parameter	Min.	Typ.	Max.	Units	Conditions
Q <sub>g</sub>	Total Gate Charge (turn-on)	—	340	510	nC	I <sub>C</sub> = 60A V <sub>CC</sub> = 400V V <sub>GE</sub> = 15V See Fig.8
Q <sub>ge</sub>	Gate - Emitter Charge (turn-on)	—	44	66		
Q <sub>gc</sub>	Gate - Collector Charge (turn-on)	—	160	240		
t <sub>d(on)</sub>	Turn-On Delay Time	—	34	—	ns	T <sub>J</sub> = 25°C I <sub>C</sub> = 60A, V <sub>CC</sub> = 480V V <sub>GE</sub> = 15V, R <sub>G</sub> = 5.0Ω Energy losses include "tail" and diode reverse recovery See Fig. 9,10,18
t <sub>r</sub>	Rise Time	—	54	—		
t <sub>d(off)</sub>	Turn-Off Delay Time	—	251	377		
t <sub>f</sub>	Fall Time	—	89	133		
E <sub>on</sub>	Turn-On Switching Loss	—	0.79	—	mJ	V <sub>CC</sub> = 360V, T <sub>J</sub> = 125°C V <sub>GE</sub> = 15V, R <sub>G</sub> = 5.0Ω
E <sub>off</sub>	Turn-Off Switching Loss	—	1.98	—		
E <sub>ts</sub>	Total Switching Loss	—	2.77	3.1	μs	T <sub>J</sub> = 150°C, See Fig. 10,11,18 I <sub>C</sub> = 60A, V <sub>CC</sub> = 480V V <sub>GE</sub> = 15V, R <sub>G</sub> = 5.0Ω, Energy losses include "tail" and diode reverse recovery
t <sub>sc</sub>	Short Circuit Withstand Time	10	—	—		
t <sub>d(on)</sub>	Turn-On Delay Time	—	37	—		
t <sub>r</sub>	Rise Time	—	56	—		
t <sub>d(off)</sub>	Turn-Off Delay Time	—	356	—	ns	E <sub>ts</sub>
t <sub>f</sub>	Fall Time	—	177	—		
L <sub>E</sub>	Internal Emitter Inductance	—	13	—	nH	Measured 5mm from package
C <sub>ies</sub>	Input Capacitance	—	6900	—	pF	V <sub>GE</sub> = 0V V <sub>CC</sub> = 30V f = 1.0MHz See Fig. 7
C <sub>oes</sub>	Output Capacitance	—	730	—		
C <sub>res</sub>	Reverse Transfer Capacitance	—	190	—		

**Notes:**

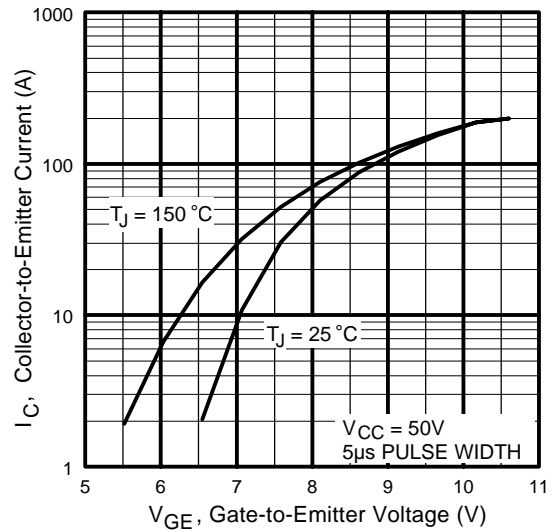
- ① Repetitive rating; V<sub>GE</sub> = 20V, pulse width limited by max. junction temperature. ( See fig. 13b )
- ② V<sub>CC</sub> = 80%(V<sub>CES</sub>), V<sub>GE</sub> = 20V, L = 10μH, R<sub>G</sub> = 5.0Ω, (See fig. 13a)
- ③ Repetitive rating; pulse width limited by maximum junction temperature.
- ④ Pulse width ≤ 80μs; duty factor ≤ 0.1%.
- ⑤ Pulse width 5.0μs, single shot.
- ⑥ Current limited by the package, (Die current = 100A)



**Fig. 1 - Typical Load Current vs. Frequency**  
(For square wave,  $I = I_{RMS}$  of fundamental; for triangular wave,  $I = I_{PK}$ )



**Fig. 2 - Typical Output Characteristics**



**Fig. 3 - Typical Transfer Characteristics**

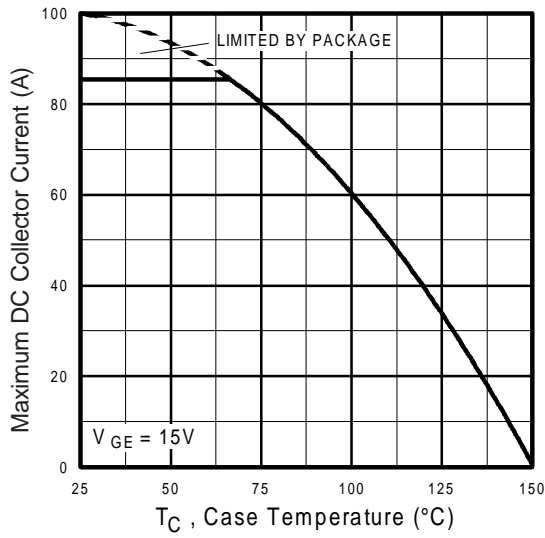


Fig. 4 - Maximum Collector Current vs. Case Temperature

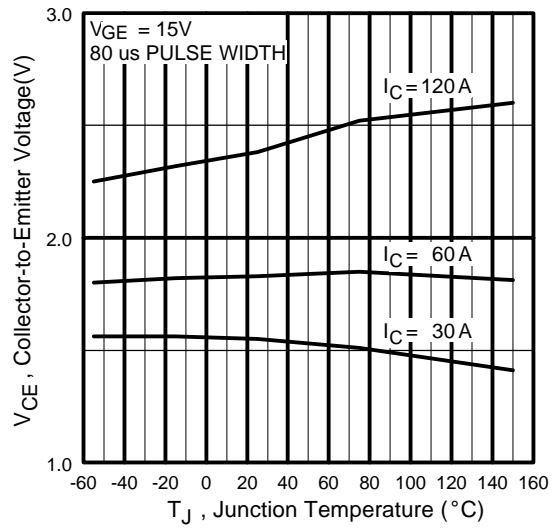


Fig. 5 - Collector-to-Emitter Voltage vs. Junction Temperature

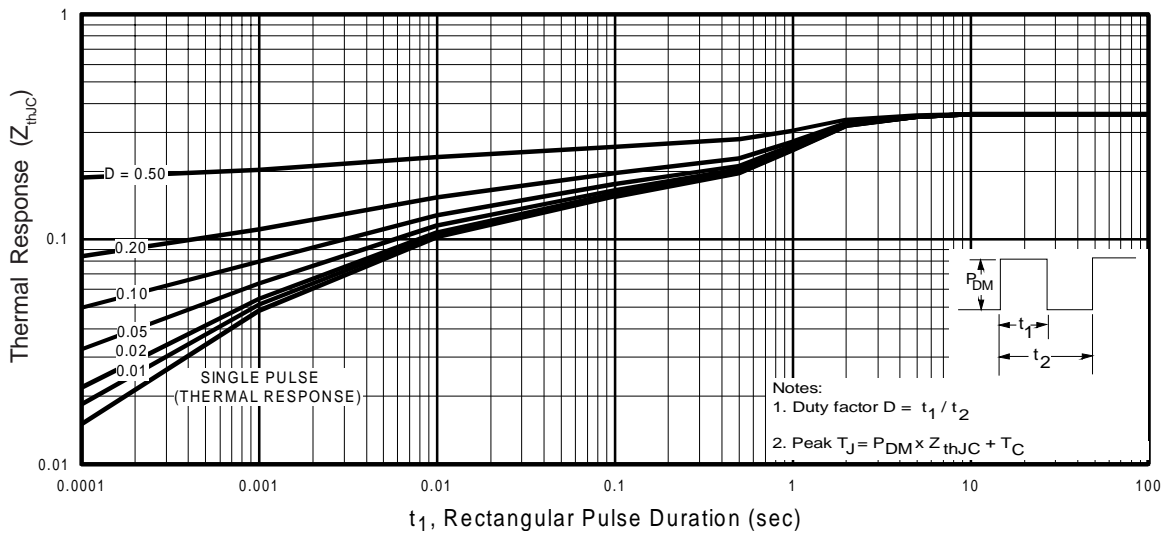


Fig. 6 - Maximum Effective Transient Thermal Impedance, Junction-to-Case

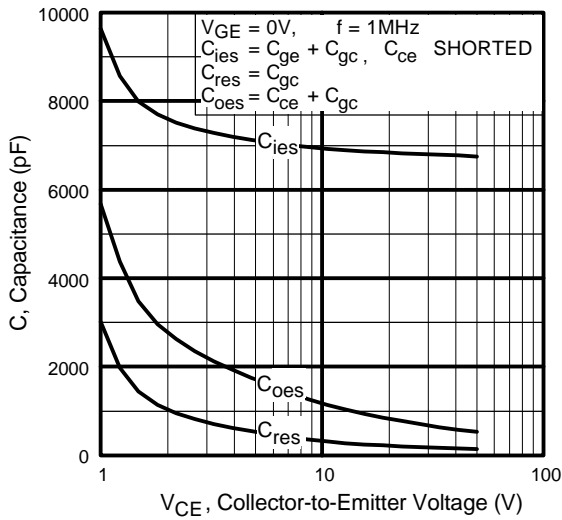


Fig. 7 - Typical Capacitance vs. Collector-to-Emitter Voltage

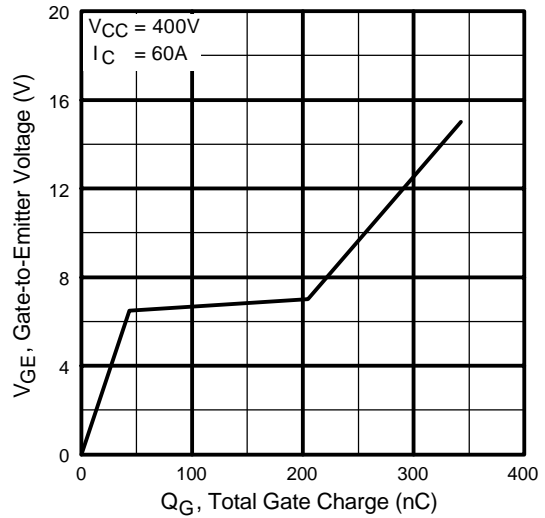


Fig. 8 - Typical Gate Charge vs. Gate-to-Emitter Voltage

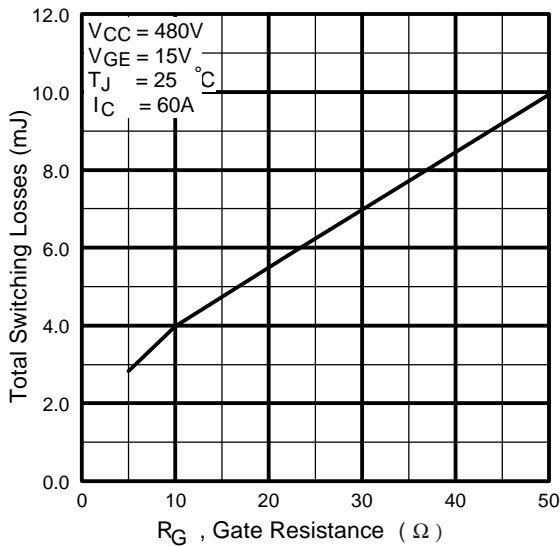


Fig. 9 - Typical Switching Losses vs. Gate Resistance

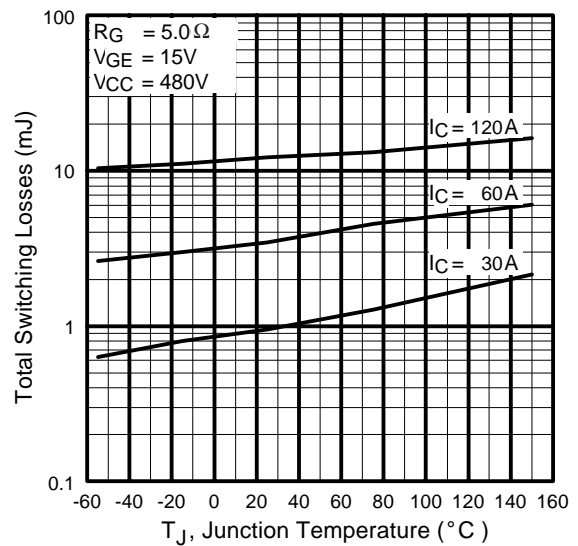
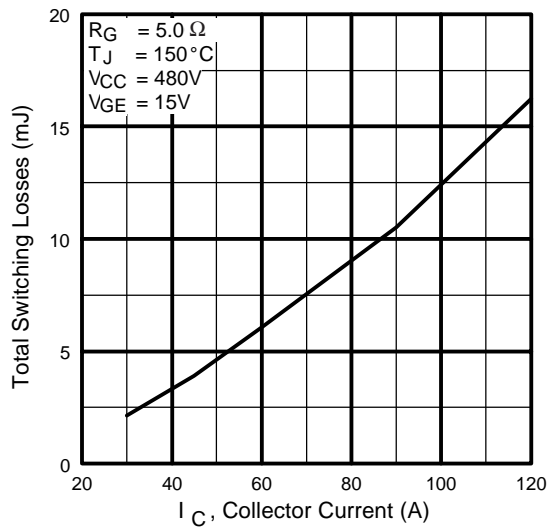
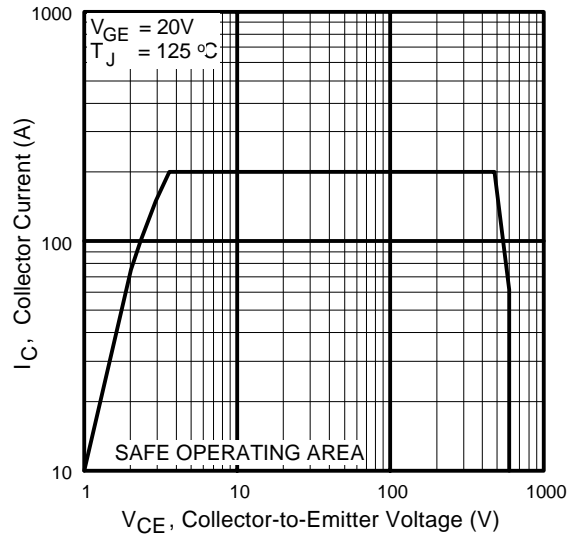


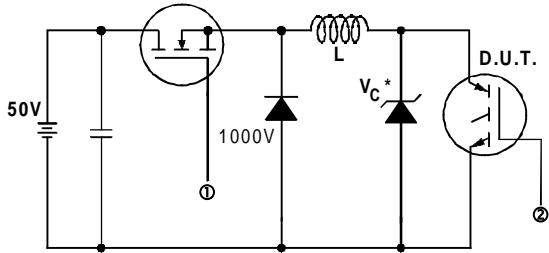
Fig. 10 - Typical Switching Losses vs. Junction Temperature



**Fig. 11** - Typical Switching Losses vs. Collector-to-Emitter Current

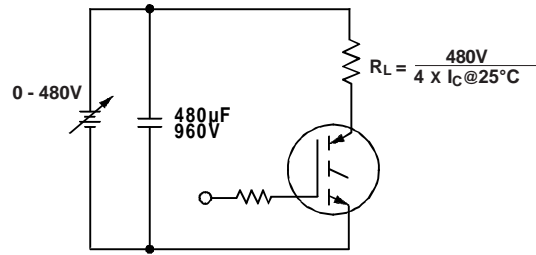


**Fig. 12** - Turn-Off SOA



\* Driver same type as D.U.T.;  $V_c = 80\%$  of  $V_{ce(max)}$   
 \* Note: Due to the 50V power supply, pulse width and inductor will increase to obtain rated  $I_d$ .

**Fig. 13a** - Clamped Inductive Load Test Circuit

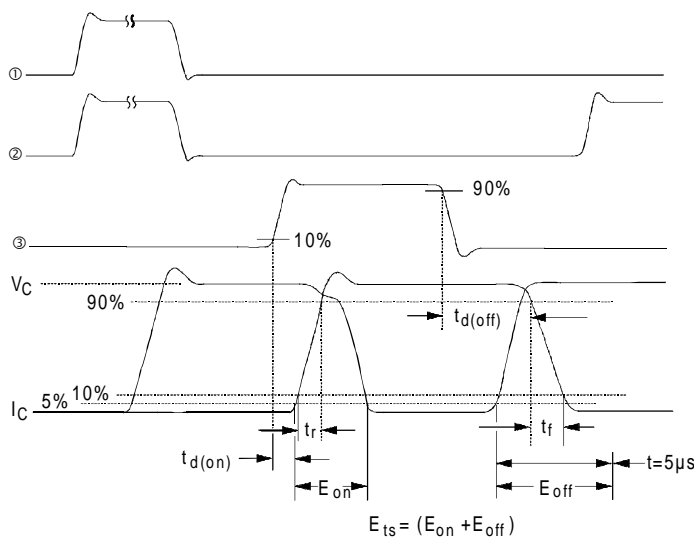


**Fig. 13b** - Pulsed Collector Current Test Circuit



**Fig. 14a** - Switching Loss Test Circuit

\* Driver same type as D.U.T.,  $V_C = 480V$



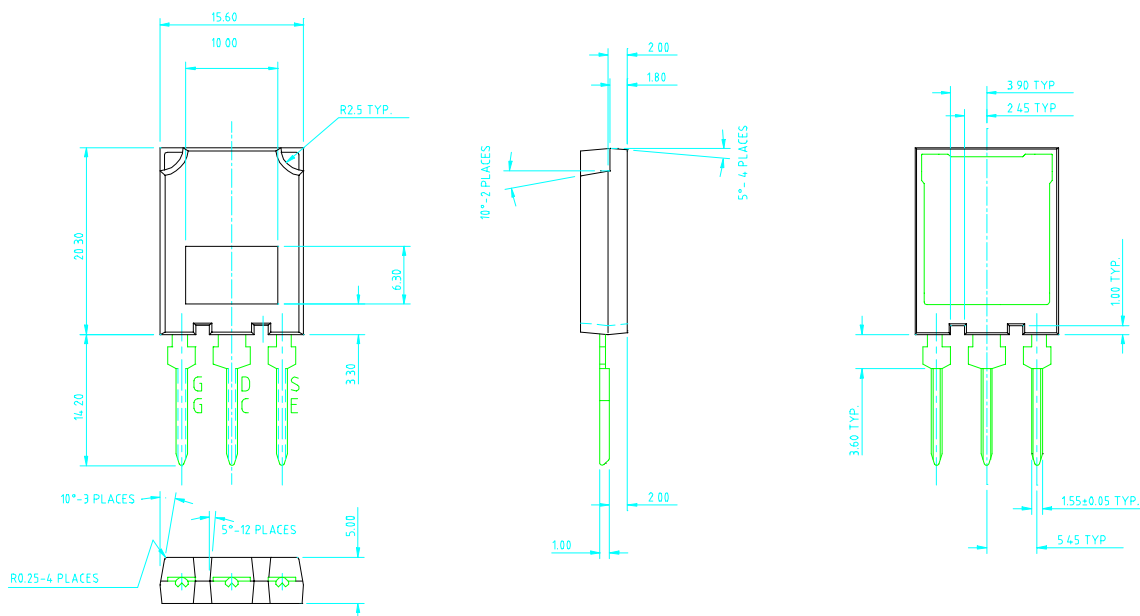
**Fig. 14b** - Switching Loss Waveforms

# IRG4PSC71K

International  
**IR** Rectifier

## Case Outline and Dimensions — Super-247

Dimensions are shown in millimeters



International  
**IR** Rectifier

**WORLD HEADQUARTERS:** 233 Kansas St., El Segundo, California 90245, Tel: (310) 322 3331

**IR GREAT BRITAIN:** Hurst Green, Oxted, Surrey RH8 9BB, UK Tel: ++ 44 1883 732020

**IR CANADA:** 15 Lincoln Court, Brampton, Ontario L6T3Z2, Tel: (905) 453 2200

**IR GERMANY:** Saalburgstrasse 157, 61350 Bad Homburg Tel: ++ 49 6172 96590

**IR ITALY:** Via Liguria 49, 10071 Borgaro, Torino Tel: ++ 39 11 451 0111

**IR FAR EAST:** K&H Bldg., 2F, 30-4 Nishi-Ikebukuro 3-Chome, Toshima-Ku, Tokyo Japan 171 Tel: 81 3 3983 0086

**IR SOUTHEAST ASIA:** 1 Kim Seng Promenade, Great World City West Tower, 13-11, Singapore 237994 Tel: ++ 65 838 4630

**IR TAIWAN:** 16 Fl. Suite D. 207, Sec. 2, Tun Haw South Road, Taipei, 10673, Taiwan Tel: 886-2-2377-9936

<http://www.irf.com/> Data and specifications subject to change without notice. 5/99