

LZ1132BD/LZ1132BM/LZ1132BR

32-Unit High Voltage MOS IC

Description

The LZ1132BD/LZ1132BM/LZ1132BR is a 300V 32-output-port monolithic IC fabricated using Sharp's advanced P-channel DMOS process. It can be used as a matrix driver for electroluminescent panels, plasma display panels, electrostatic printers.

Features

1. High voltage output 300 (MIN.)
2. Output current 45mA (TYP.) at $V_{HVO}=300V$
3. Internal 32-bit shift register circuit
4. Expandable circuit structure
5. High speed data transfer (clock frequency 4MHz)
6. Single power supply : -5V
7. DMOS process
8. 44-pin quad-flat package (LZ1132BM/LZ1132BR*)
42-pin dual-in-line package (LZ1132BD)

* Reversed bend pin

Pin Connections

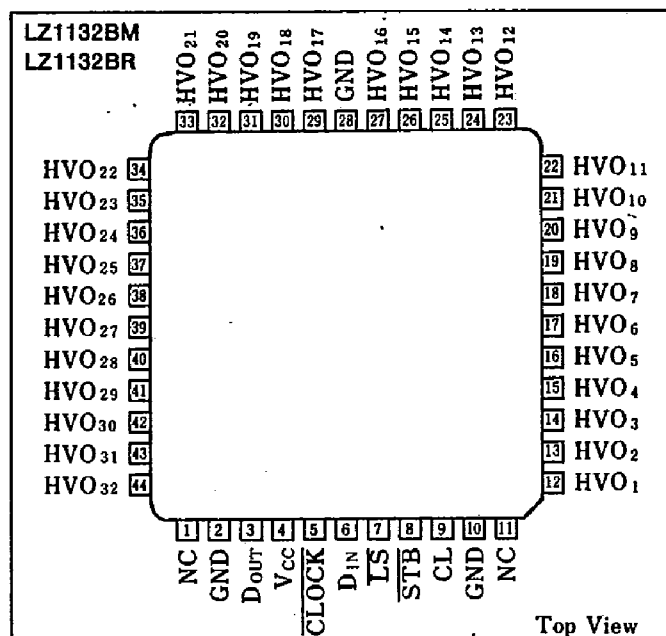

LZ1132BD

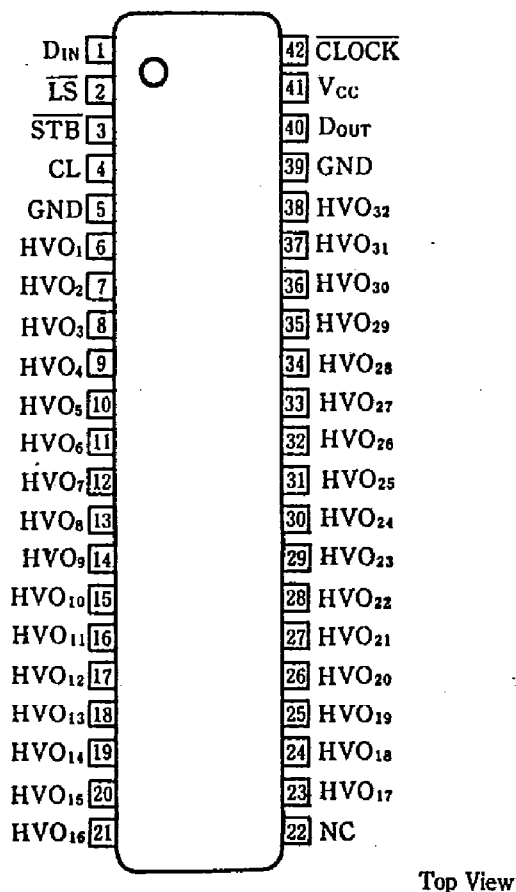

Block Diagram

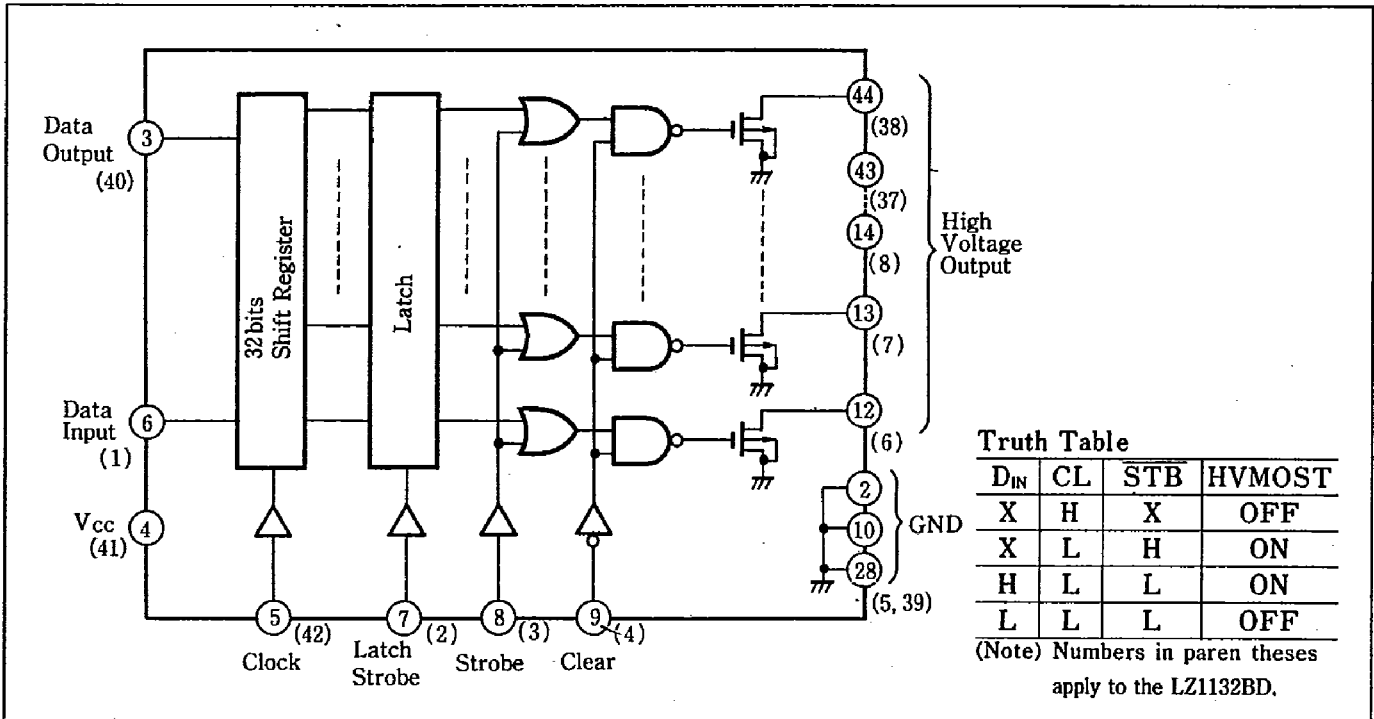

Absolute Maximum Ratings

(Ta=25°C)

Parameter	Symbol	Conditions	Ratings	Unit	Note
Supply voltage	V _{CC}		-7 to +0.3	V	1
Input voltage	V _{IN}	Applied to all input pins.	-7 to +0.3	V	1
Output voltage	V _{OUT}	Applied to the data output	-7 to +0.3	V	1
	V _{HVO(ON)}		-300 to +0.3	V	1,2
	V _{HVO(OFF)}		-350 to +0.3	V	1,3
Power consumption	P _D	Ta ≤ 25°C	600	mW	
P _D derating ratio	ΔP _D /°C	Ta > +25°C	5	mW/°C	
Operating temperature	T _{OPR}		-20 to +70	°C	
Storage temperature	T _{STG}		-55 to +150	°C	

Note 1: The maximum applicable voltage on any pin with respect to GND.

Note 2: The maximum applicable voltage when HVMOST is ON. D (duty cycle) = 0.1%, ON time = 10 μs

Note 3: The maximum applicable voltage when HVMOST is OFF.

DC Characteristics

(1) HVMOST Characteristics

(V_{CC} = -5V ± 10%)

Parameter	Symbol	Conditions	MIN.	TYP.	MAX.	Unit	Note
ON-state resistance	R _{ON}	HVMOST "ON" I _{HVO} = -1mA, Ta = 25°C		1.0	1.3	Ω	
Output current	I _{HVO}	HVMOST "ON" V _{HVO} = -300V, Ta = 25°C	-40	-45		mA	1
Output leakage current	I _L	HVMOST "OFF" V _{HVO} = -300V, Ta = -20 to +70°C			10	μA	2
Total output leakage current	I _{TL}	HVMOST "OFF" V _{HVO} = -300V, Ta = -20 to 70°C			30	μA	3

Note 1: Duty cycle = 0.1%, ON time = 10 μs

Note 2: Value for each HVMOST output pin.

Note 3: Sum of total output leakage current.

(2) Logic Section Characteristics

($V_{CC}=5V \pm 10\%$, $T_a = -20$ to $+70^\circ C$)

Parameter	Symbol	Conditions	MIN.	TYP.	MAX.	Unit
Supply voltage	I_{CC}	$V_{IN}=0V$		-8	-16	mA
Input "High" voltage	V_{IH}		-0.8		0.3	V
Input "Low" voltage	V_{IL}		V_{CC}		-2.4	V
Output "High" voltage	V_{OH}	$I_{OH} = -0.2mA$; applied to $\overline{D_{OUT}}$	-0.5			V
Output "Low" voltage	V_{OL}	$I_{OL} = 1.6mA$; applied to $\overline{D_{OUT}}$			-2.5	V
Input leakage current	I_{IL}	$V_{IN}=0V$ to V_{CC}			10	μA

AC Characteristics

($V_{CC}=5V \pm 10\%$, $T_a = -20$ to $+70^\circ C$)

Parameter	Symbol	Conditions	MIN.	TYP.	MAX.	Unit	Note
Clock frequency	f_ϕ				4	MHz	
Clock pulse width	$t_\phi, t_{\overline{\phi}}$		125			ns	
$\overline{D_{IN}}$ setup time	t_{DS}		60			ns	
$\overline{D_{IN}}$ hold time	t_{DH}		60			ns	
LS pulse width	t_{LP}		150			ns	
Clock to LS delay	t_{CL}		0			ns	
LS to clock delay	t_{LC}		0			ns	
$\overline{D_{OUT}}$ delay	t_{PD}	$C_L (\overline{D_{OUT}}) = 30pF$			250	ns	
LS to STB delay	t_{LSB}		0			ns	
LS to \overline{CL} delay	t_{LCL}		0			ns	
STB pulse width	t_{SP}		1			μs	
\overline{CL} pulse width	t_{CLP}		1			μs	
HVO fall time	t_{PL}	$C_L (HVO) = 900pF, R_L = 20k\Omega$			60	μs	
HVO rise time	t_{PH}	$C_L (HVO) = 900pF, R_L = 20k\Omega$			15	μs	1

Note 1: Output delay time varies depending on load condition.

Test conditions

- Input rise/fall time: 20 ns
- Time measurement level: 50%
- HVO output load conditions (figure at right).

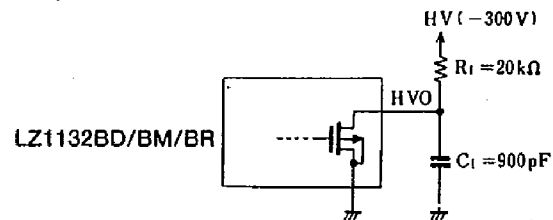

Capacitance

($V_{CC}=0V, f=1MHz, T_a=25^\circ C$)

Parameter	Symbol	Conditions	MIN.	TYP.	MAX.	Unit
Input capacitance	C_{IN}	$V_{IN}=0V$		6	10	pF
Output capacitance	C_{HVO}	$V_{HVO}=0V$		17	30	pF

All pins except pin being measurement are connected to GND.

AC Timing Diagram

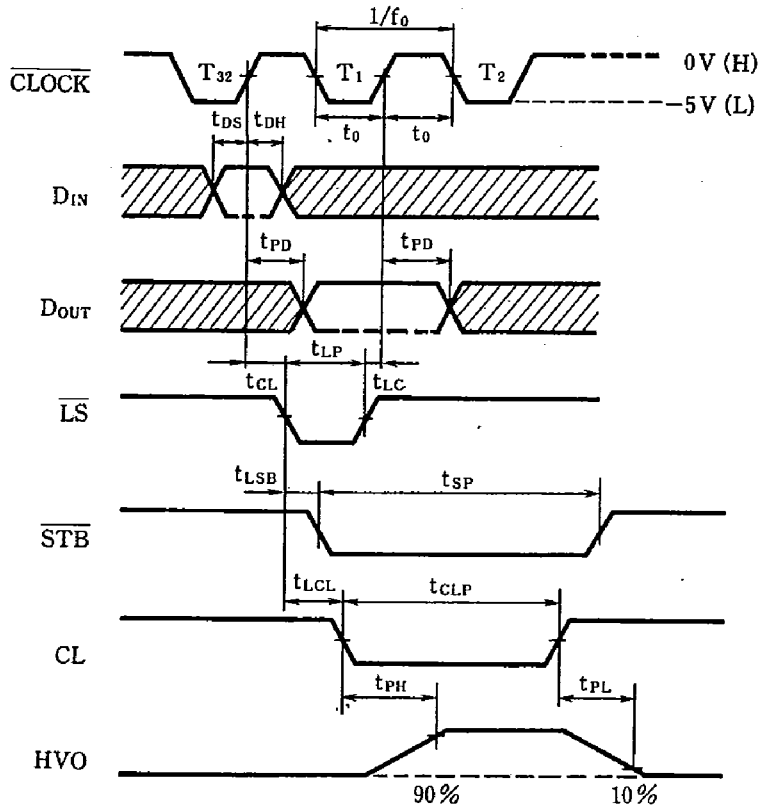

Electrical Characteristic Curve

ON resistance vs. Ambient temperature

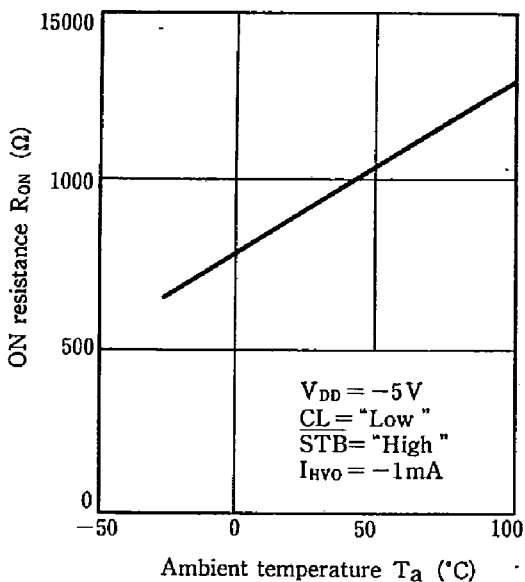

Output current vs. Ambient temperature

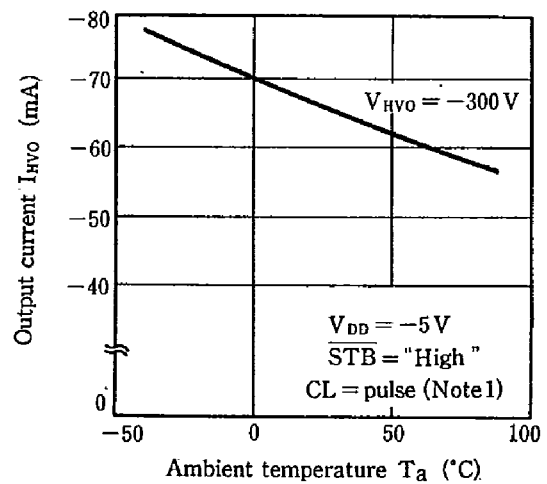

Output current vs. Output voltage

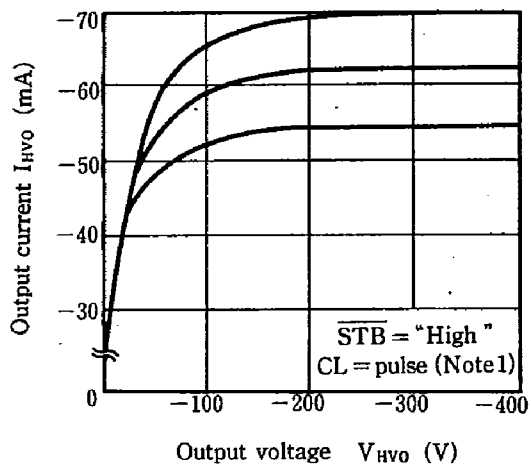

Note1 : Apply below pulse to the CL.

