

TENTATIVE TOSHIBA BIPOLAR LINEAR INTEGRATED CIRCUIT SILICON MONOLITHIC

TA1204AF

γ CORRECTION IC FOR LCD TV

TA1204AF is γ correction IC, that have common drive circuit, for small or medium TFT panel (Normally White).
TA1204AF is flat 44 pin package. TA1204AF have two linear RGB inputs.

FEATURES

- Two linear RGB inputs
- Selectable DC coupling or AC coupling (pedestal clamp) input for both inputs
- γ correction circuit with RGB fine adjustments
- Drive gain control circuit with RGB fine adjustments
- Cutoff level control circuit with RGB fine adjustments
- Brightness and Contrast control circuits
- AC and DC controls for the common electrode
- Pre-drive output circuit with feedback input for common electrode
- RGB output with Horizontal and /or Vertical reverse circuit

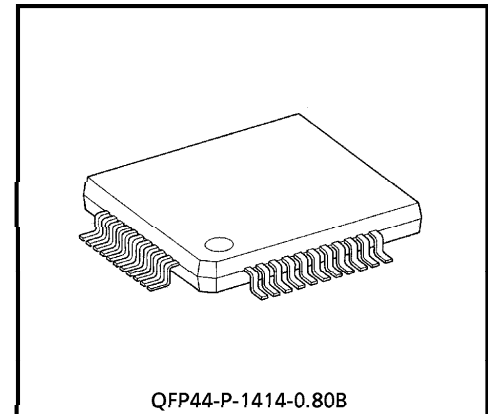

QFP44-P-1414-0.80B

Weight : 1.15g (Typ.)

980508EBA1

- TOSHIBA is continually working to improve the quality and the reliability of its products. Nevertheless, semiconductor devices in general can malfunction or fail due to their inherent electrical sensitivity and vulnerability to physical stress. It is the responsibility of the buyer, when utilizing TOSHIBA products, to observe standards of safety, and to avoid situations in which a malfunction or failure of a TOSHIBA product could cause loss of human life, bodily injury or damage to property. In developing your designs, please ensure that TOSHIBA products are used within specified operating ranges as set forth in the most recent products specifications. Also, please keep in mind the precautions and conditions set forth in the TOSHIBA Semiconductor Reliability Handbook.
- The products described in this document are subject to foreign exchange and foreign trade laws.
- The information contained herein is presented only as a guide for the applications of our products. No responsibility is assumed by TOSHIBA CORPORATION for any infringements of intellectual property or other rights of the third parties which may result from its use. No license is granted by implication or otherwise under any intellectual property or other rights of TOSHIBA CORPORATION or others.
- The information contained herein is subject to change without notice.

BLOCK DIAGRAM

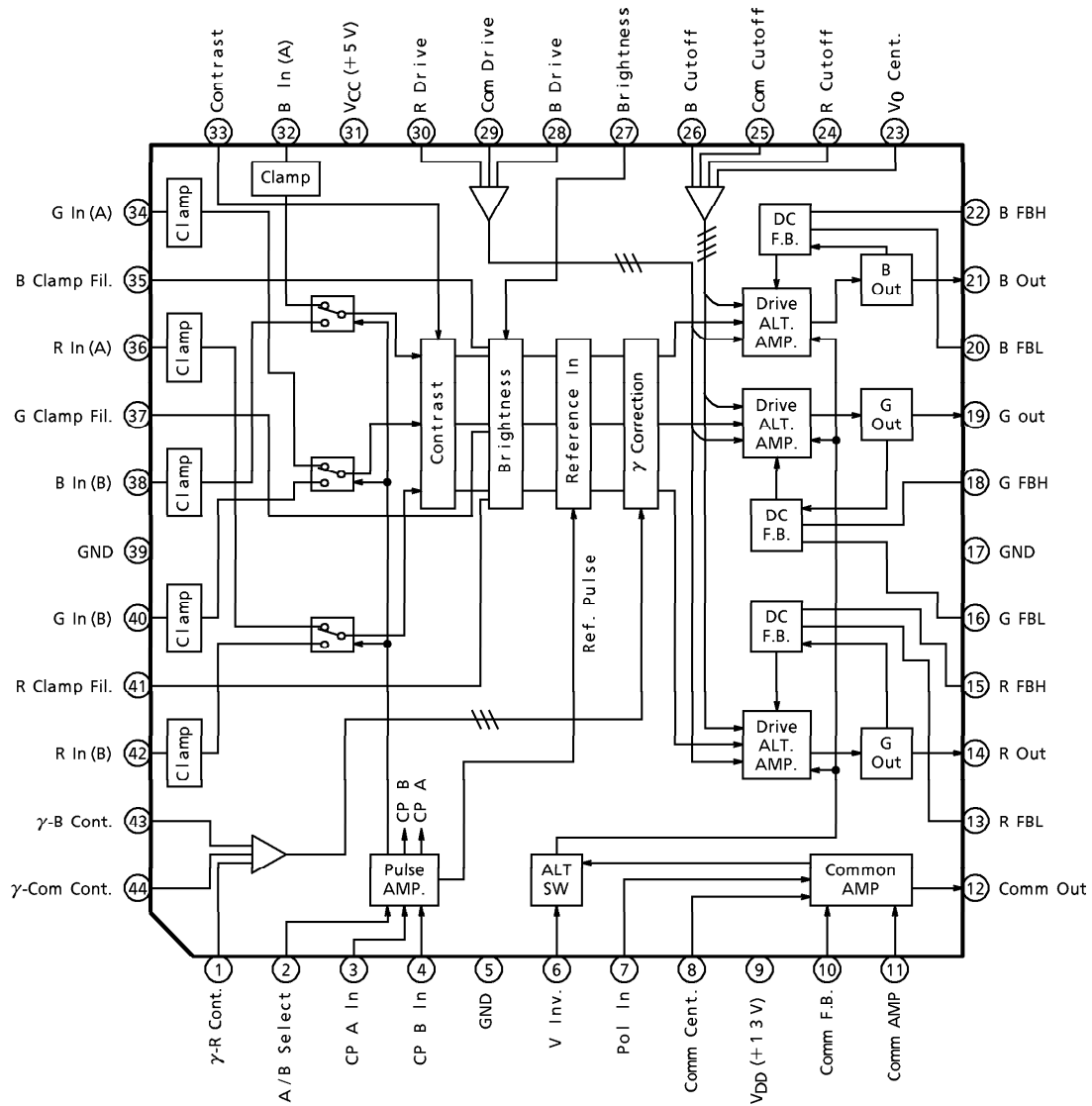

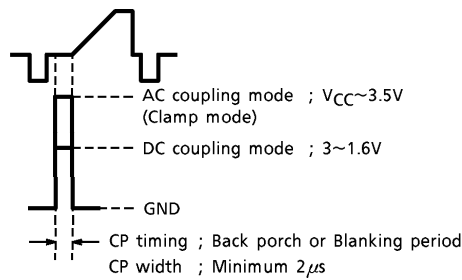

The Method of Clamping Pulse (CP) A/B

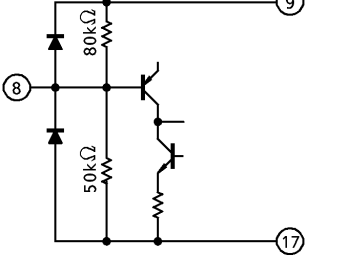
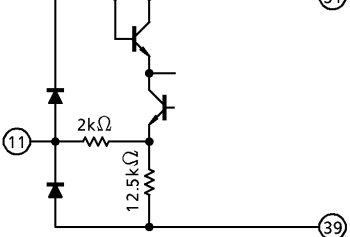
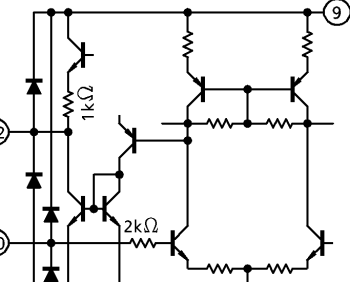
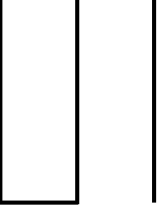

PIN FUNCTION

PIN No.	PIN NAME	FUNCTION	INTERFACE	INPUT / OUTPUT SIGNAL
2	A / B select	Switches input. Do not leave open. Do not switch duration from $2\mu s$ before, to $4\mu s$ after clamp pulse A / B. If pin 2 is not in use, fixed to V_{CC} (5V) or GND.		
3 4	CP A IN CP B IN	Inputs clamp pulse. Set clamp pulse width to at least $2\mu s$. If pin 3 or 4 is not in use, fix to GND.		
5	GND	GND pin for block to which power is supplied from V_{DD} pin. Connect to 17 and 39 GND pins using short thick line.	—	—
6	V Inv.	Switches vertical polarity inverted phase. Switching between pins 6 and 7 switches RGB and VCOM outputs. Do not leave open. If pin 6 is not in use, fixed to V_{CC} (5V) or GND.		
7	Pol In	Input polarity signal. If pin 7 is not in use, fixed to V_{CC} (5V) or GND. When pin 6 is High : H : negative polarity output; VCOM output is High. L : positive polarity output; VCOM output is Low. When pin 6 is Low : H : positive polarity output; VCOM output is High. L : negative polarity output; VCOM output is Low.		

PIN No.	PIN NAME	FUNCTION	INTERFACE	INPUT / OUTPUT SIGNAL
8	Comm Cent	Adjusts common output center voltage. When left open, biased 5V. Voltage on this pin is used as common output center voltage.		DC input Adjustable voltage range : 0.3 to 11V
9	V _{DD} (+ 13V)	V _{DD} pin Connect 13V (typ.). Depending on RGB output load or adjustment conditions, oscillation waveform may appear on output pin. Thus, connect a bypass capacitor near this pin.	—	—
11	Comm AMP	Adjusts common output amplitude. When left open, biased 2.5V. When voltage is adjusted to 2.5V, amplitude of Comm FB is about 5V _{p-p} .		DC current input : - 0.2mA (sink current) to 1.25mA (source current) VCOM amplitude : 0V _{p-p} to 8.8V _{p-p}
10	Comm F.B.	Inputs common output feedback signal. Connect common output buffer. Maximum output current : 250μA. Control Comm Out pin waveform so that common drive waveform input to this pin has center voltage and amplitude which are set by Comm Cent and Comm AMP pins.		
12	Comm Out	Outputs drive signal for common output buffer. Connect common drive buffer.		

PIN No.	PIN NAME	FUNCTION	INTERFACE	INPUT / OUTPUT SIGNAL
13 16 21	R FBL G FBL B FBL	Connect filter for canceling positive offset in relation to each axis.		DC
14 19 21	R Out G Out B Out	Outputs R / G / B signal. Up to 300pF capacity can be driven.		
15 18 22	R FBH G FBH B FBH	Connect filter for canceling negative offset in relation to each axis.		DC
17	GND	GND pin for block to which power is supplied from V _{DD} pin. Connect to 5 and 39 GND pins using short thick line.	—	—
23	V0 Cent.	Adjusts output signal center voltage. When left open, biased 1/2V _{DD} . Voltage on this pin is used as common output center voltage.		DC input Adjustable voltage range : 1 to 11.4V

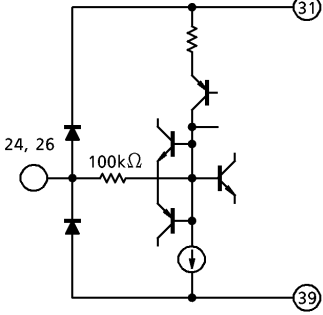
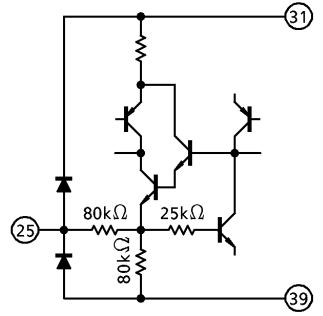
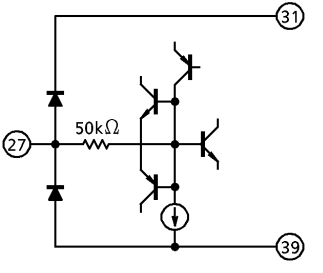
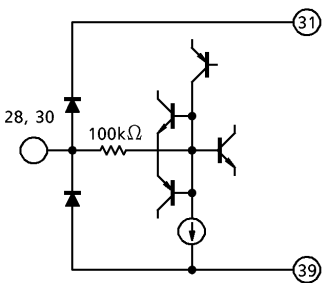
PIN No.	PIN NAME	FUNCTION	INTERFACE	INPUT / OUTPUT SIGNAL
24 26	R Cutoff B Cutoff	Fine-adjusts cutoff voltage for R / B axis. When left open, biased 2.5V. When voltage is adjusted to 2.5V, cutoff fine voltage is 0V (typ.) in relation to G axis.		DC input 0 to 5V Cutoff voltage : - 2 to 2V
25	Com Cutoff	Adjusts common cutoff voltage. Batch-adjust three axes. When left open, biased 2.5V. When voltage is adjusted to 2.5V, cutoff voltage is 5V (typ.).		DC input 0 to 5V Cutoff voltage : 10 to 0V
27	Brightness	Adjusts brightness. Batch-adjusts three axes. When left open, biased 3.3V. When voltage is adjusted to 3.3V, brightness voltage is 0V (typ.), center.		DC input 0 to 5V Brightness voltage : 3.8 to -2V
28 30	B Drive R Drive	Fine-adjusts drive voltage for B / R axis. When left open, biased 2.5V. When voltage is adjusted to 2.5V, drive voltage adjustment is 0% (typ.).		DC input 0 to 5V Output amplitude : 45 to 150%

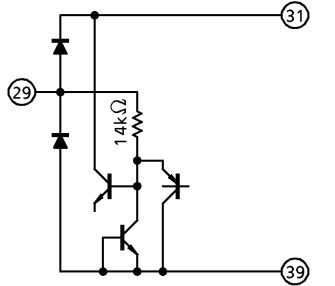
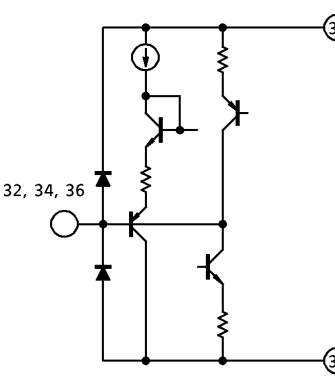
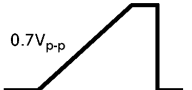
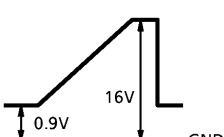
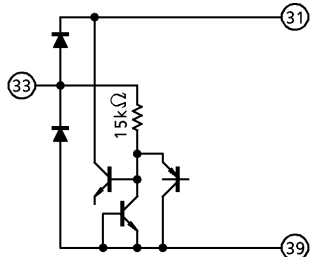
PIN No.	PIN NAME	FUNCTION	INTERFACE	INPUT / OUTPUT SIGNAL
29	Com Drive	Adjusts drive voltage. Batch-adjusts three axes. Do not leave open.		<p>DC input 1.2 to 4.5V</p> <p>Output amplitude : 1.4 to 11V_{p-p}</p>
31	VCC (+5V)	VCC pin Connect 5V (typ.). Connect bypass capacitor near this pin.	—	—
32 34 36	B In (A) G In (A) R In (A)	Input R / G / B (A) signal. In Clamp mode, input via clamp capacitor.		<p>100IRE = 0.7V_{p-p} Clamp mode</p>  <p>DC mode</p> 
33	Contrast	Adjusts contrast. Batch-adjusts three axes. Do not leave open.		<p>DC input 1.7 to 4.1V</p> <p>Signal amplitude : - 30dB or below to 7dB</p>

PIN No.	PIN NAME	FUNCTION	INTERFACE	INPUT / OUTPUT SIGNAL
35	B Clamp Fil.	Connect B-axis γ input pedestal offset cancel filter. Use G-axis pedestal as reference.		DC
37	G Clamp Fil.	Connect G-axis γ input pedestal offset cancel filter. Use brightness adjustment voltage as reference.		
41	R Clamp Fil.	Connect R-axis γ input pedestal offset cancel filter. Use G-axis pedestal as reference.		
38 40 42	B In (B) G In (B) R In (B)	Input RGB (B) signal. In Clamp mode, input via clamp capacitor.		<p>100IRE = 0.7V_{p-p} Clamp mode</p> <p>DC mode</p>
39	GND	GND pin for block to which power is supplied from V _{CC} pin. Connect to 5 and 17 GND pins using short thick line.	—	—
1 43	γ -R Cont γ -B Cont	Fine-adjusts R/B-axis γ characteristic. When left open, biased 3.7V. When voltage is adjusted to 3.7V, γ adjustment is typically 78% (at 60% white input).		<p>DC input 0 to 5V</p> <p>γ adjustment : 66 to 78% (at 60% white input)</p>
44	γ -Com Cont	Adjusts common γ characteristic. Batch-adjusts three axes. When left open, biased 2.5V. When voltage is adjusted to 2.5V, γ adjustment is typically 72% (at 60% white input).		<p>DC input 0.9 to 4.9V</p> <p>γ adjustment : 82 to 60% (at white 60% input)</p>

MAXIMUM RATINGS (Ta = 25 ± 3°C)

CHARACTERISTIC	SYMBOL	RATING	UNIT
Supply Voltage 1	V _{DD}	15	V
Supply Voltage 2	V _{CC}	8	V
Power Dissipation	P _{Dmax.}	960 (Note 1)	mW
Input Signal Voltage	E _{in}	GND - 0.3~V _{CC} + 0.3 GND - 0.3~V _{DD} + 0.3	V
Operating Temperature	T _{opr}	- 20~65	°C
Storage Temperature	T _{stg}	- 55~150	°C

(Note 1) See figure below.

(Note 2) Pin34, 36, 38, 40 and Pin42 are weak against static electricity and surge impulse. Please take counter measure to meet, if necessary.

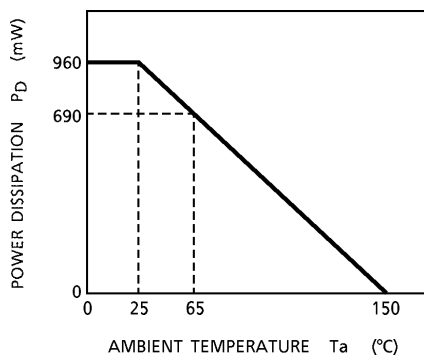

Figure Temperature decrease curve of power dissipation

RECOMMENDED SUPPLY VOLTAGE

PIN No.	PIN NAME	MIN	TYP	MAX	UNIT
9	V _{DD}	12.5	13.0	13.5	V
31	V _{CC}	4.5	5.0	5.5	V

ELECTRICAL CHARACTERISTICS

(Unless otherwise specified, $V_{CC} = 5.0V$, $V_{DD} = 13.0V$, $T_a = 25 \pm 3^\circ C$)

DC CHARACTERISTICS

CHARACTERISTIC	SYMBOL	TEST CIR-CUIT	TEST CONDITION	MIN	TYP	MAX	UNIT
Supply Current 1	I_{CC}	—	—	17.6	22.0	29.3	mA
Supply Current 2	I_{DD}	—	—	13.6	17.0	22.7	mA
γ -R Cont.	V_1	—	—	3.5	3.7	3.9	V
Comm Cent.	V_8	—	—	4.8	5.0	5.2	V
Comm F.B.	V_{10}	—	—	4.6	5.0	5.4	V
Comm AMP	V_{11}	—	—	2.3	2.5	2.7	V
Comm Out	V_{12}	—	—	4.65	5.05	5.45	V
R FBL	V_{13}	—	—	2.65	3.05	3.45	V
R Out	V_{14}	—	—	6.2	6.5	6.8	V
R FBH	V_{15}	—	—	2.6	3.0	3.4	V
G FBL	V_{16}	—	—	2.65	3.05	3.45	V
G FBH	V_{18}	—	—	2.6	3.0	3.4	V
G Out	V_{19}	—	—	6.2	6.5	6.8	V
B FBL	V_{20}	—	—	2.65	3.05	3.45	V
B Out	V_{21}	—	—	6.2	6.5	6.8	V
B FBH	V_{22}	—	—	2.6	3.0	3.4	V
V_0 Cent	V_{23}	—	—	6.3	6.5	6.7	V
R Cutoff	V_{24}	—	—	2.3	2.5	2.7	V
Com Cutoff	V_{25}	—	—	2.3	2.5	2.7	V
B Cutoff	V_{26}	—	—	2.3	2.5	2.7	V
Brightness	V_{27}	—	—	3.1	3.3	3.5	V
B Drive	V_{28}	—	—	2.3	2.5	2.7	V
R Drive	V_{30}	—	—	2.3	2.5	2.7	V
B In1	V_{32}	—	—	0.7	0.9	1.1	V
G In1	V_{34}	—	—	0.7	0.9	1.1	V
B Clamp Fil.	V_{35}	—	—	2.2	2.8	3.4	V
R In1	V_{36}	—	—	0.7	0.9	1.1	V
G Clamp Fil.	V_{37}	—	—	2.2	2.8	3.4	V
B In2	V_{38}	—	—	0.7	0.9	1.1	V
G In2	V_{40}	—	—	0.7	0.9	1.1	V
R Clamp Fil.	V_{41}	—	—	2.2	2.8	3.4	V
R In2	V_{42}	—	—	0.7	0.9	1.1	V
γ -B Cont.	V_{43}	—	—	3.5	3.7	3.9	V
γ -Com Cont.	V_{44}	—	—	2.3	2.5	2.7	V

AC CHARACTERISTICS

CHARACTERISTIC		SYMBOL	TEST CIR-CUIT	TEST CONDITION	MIN	TYP	MAX	UNIT
RGB Input Dynamic Range		A_{in}	—	(Note 1)	1.5	1.8	2.1	V
Cross Talk Between Channels		X_{ch}	—	(Note 2)	—	-60	-46	dB
Crosstalk Over Switching Circuit		X_{sw}	—	(Note 3)	—	-60	-50	dB
Output Signal Amplitude	Typical	S_{out}	—	(Note 4)	2.9	3.3	3.7	V_{0-p}
	Deviation	ΔS_o	—		—	—	250	mV
	Polarity Gap	ΔS_{op}	—		—	—	100	mV
Contrast Adj.	Max. Gain	ACM	—	(Note 5)	5.6	6.7	7.6	dB
	Deviation	ΔACM	—		—	—	0.5	dB
Brightness Adj.	Typical	B_{rs}	—	(Note 6)	-0.33	-0.17	-0.01	V
	Deviation	ΔB_{rs}	—		—	—	100	mV
	Max. Gain	B_{rM}	—	(Note 7)	3.2	3.8	4.4	V
	Max. Deviation	ΔB_{rM}	—		—	—	200	mV
	Min. Gain	B_{rL}	—	(Note 8)	-2.6	-2.1	-1.5	V
	Min. Deviation	ΔB_{rL}	—		—	—	200	mV
Cut-off	Typical Level	C_{oS}	—	(Note 9)	4.6	5	5.4	V
	Typical Deviation	ΔC_{oS}	—		—	—	100	mV
	Max. Range	C_{oM}	—	(Note 10)	9.3	9.8	10.3	V
	Max. Deviation	ΔC_{oM}	—		—	—	100	mV
	Min. Range	C_{oL}	—	(Note 11)	0	0.07	0.5	V
Min. Deviation	ΔC_{oL}	—	—		—	100	mV	
Cut-off Fine Adjustment Range	Max.	C_{vM}	—	(Note 12)	1.7	1.95	2.1	V
	Min.	C_{vL}	—		-2.1	-1.95	-1.8	
	Deviation	ΔC_{vp}	—		—	—	250	mV
Drive Output Amplitude	Max.	C_{oM}	—	(Note 13)	10.6	11.15	11.7	V
	Max. Deviation	ΔC_{oM}	—		—	—	150	mV
	Min.	D_{oL}	—	(Note 14)	0.95	1.35	1.75	V
	Min. Deviation	ΔD_{oL}	—		—	—	150	mV
Drive Fine Adjustment	Max.	C_{vM}	—	(Note 15)	145	151.5	157	%
	Min.	C_{vL}	—		39	45.5	52	
	Deviation	ΔC_{vp}	—		—	—	5	

CHARACTERISTIC		SYMBOL	TEST CIR-CUIT	TEST CONDITION	MIN	TYP	MAX	UNIT
Output Frequency Response		f_{out}	—	(Note 16)	8	12	—	MHz
Output Frequency Response Deviation		Δf_{out}	—		—	—	0.5	
Output Dynamic Range		A_{out}	—	(Note 17)	10.6	11.15	11.7	V_{p-p}
Output Through Rate		SR_S	—	(Note 18)	50	65	—	$V / \mu s$
Output S/N		SN	—	(Note 19)	50	—	—	dB
Polarity Reverse Center Voltage	Typical	V_{oS}	—	(Note 20)	6.18	6.48	6.78	V
	Deviation	ΔV_{oS}	—		—	—	100	mV
Polarity Reverse Center Voltage	Max. Variable Range	V_{oM}	—	(Note 21)	11.08	11.38	11.58	V
	Min. Variable Range	V_{oL}	—		0.74	0.94	1.14	
	Deviation	ΔV_{oML}	—		—	—	100	mV
γ Characteristic	Typical	G_S	—	(Note 22)	67	72	77	%
	Deviation	ΔG_S	—		—	—	5	%
	Polarity Gap	ΔG_{sp}	—		—	—	3	%
γ Characteristic Variable Range	Max.	G_{SM}	—	(Note 23)	75	81.5	85	%
	Min.	G_{SL}	—		57	60	63	
	Deviation	ΔG_{SML}	—		—	—	53	
γ Fine Adjustment Characteristic Variable Range	Max.	G_{VM}	—	(Note 24)	73	78	83	%
	Min.	G_{VL}	—		61	66	71	
	Deviation	ΔG_{VML}	—		—	—	5	
Common Drive Output Typical Amplitude		S_{cS}	—	(Note 25)	4.6	5.1	5.6	V_{p-p}
Common Drive Output Amplitude Variable Range	Max.	S_{cM}	—	(Note 26)	8.1	8.8	8.9	V
	Min.	S_{cL}	—		—	0	0.5	
Typical Common Drive Center Voltage		V_{cS}	—	(Note 27)	4.7	5	5.2	V
Common Drive Center Voltage Variable Range	Max.	V_{cM}	—	(Note 28)	10.7	11	11.3	V
	Min.	V_{cL}	—		0.1	0.27	0.5	
Common Drive Output Through Rate		SR_C	—	(Note 29)	5	9	—	$V / \mu s$
Clamp Signal Input Threshold 1		V_{CP1}	—	(Note 30)	1.2	1.4	1.6	V
Clamp Signal Input Threshold 2		V_{CP2}	—	(Note 31)	3.3	3.5	3.7	V
Input-Switching Signal Threshold		V_{SEL}	—	(Note 32)	2.3	2.5	2.7	V
Polarity Reverse Signal Threshold		V_{POL}	—	(Note 33)	2.4	2.6	2.8	V
Polarity Reverse Phase-Switching Signal Threshold		V_{INV}	—	(Note 34)	2.6	2.8	3	V

METHOD OF MEASUREMENT

(Note 1) Image signal input dynamic range

- Test condition 2 (direct-coupling mode)
- Input : G In1/G In2
Test signal 1

For input A, measure the peak levels at input pins 32 {34, 36} immediately before the top/down clipping of the output signals of output pins 21 {19, 14}, while adjusting VR34 and changing the pedestal levels at the end of the input pin. Specify the difference between the upper and lower measurement values as the dynamic range to be obtained.

For input B, change SW_{2B} from a to b, adjust VR40, and take the same measurements for input pins 38 {40, 42}.

(Note 2) Inter-channel crosstalk 1

- Test condition 5 (CP mode, fixed polarity)
- Input : X In1/X In2
Test No. 2
Measurement frequency 1MHz
- Other input pins
(Y In1·Z In1/Y In2·Z In2) : short to GND

Change SW₂₇ from a to b as before, and adjust VR27 so there is no difference between the $\gamma 0$ and black levels in the output waveform at pin 19.

For input A, input it to the X-axis (pin X In1) and measure the amplitude values of the 1MHz components at output pins 21, 19, and 14. Short to GND the other input pins (Y In1/Z In1).

$$\text{Crosstalk from the X-axis to the Y-axis} = \frac{\text{(amplitude value of the Y-axis output)}}{\text{(amplitude value of the X-axis output)}}$$

$$\text{Crosstalk from the X-axis to the Z-axis} = \frac{\text{(amplitude value of the Z-axis output)}}{\text{(amplitude value of the X-axis output)}}$$

Change the combination of X, Y, and Z among B (output pin 21), G (output pin 19), and R (output pin 14), and repeat the same measurement. For the B input, change SW_{2B} from a to b, set the input pin at BINX, short to GND the other input pins (Y In2/Z In2), and measure as for input A.

(Note 3) Switched SW crosstalk

- Test condition 5 (CP mode, fixed polarity)
- Input : X In1 (X In2 = short to GND)
/X In2 (X In1 = short to GND)
Test signal 2
Measurement frequency 1MHz

Change SW₂₇ from a to b as before, adjust VR₂₇ so there is no difference between the $\gamma 0$ level and the black level in the output waveform of pin 19, input it to the channel A X-axis (pin X In1), switch SW_{2B} from a to b, and measure the amplitude value of the 1MHz component of the X-axis output pins (pin 21 when X=B, pin 19 when X=G, and pin 14 when X=R) before and after switching.

$$\text{Crosstalk from input A to input B} = \frac{\text{(amplitude value when SW = b)}}{\text{(amplitude value when SW = a)}}$$

Change the input pin to channel B (pin X In2) and repeat the same measurement.

$$\text{Crosstalk from input B to input A} = \frac{\text{(amplitude value when SW = a)}}{\text{(amplitude value when SW = b)}}$$

Repeat this measurement replacing B, G, and R as the X-axis.

(Note 4) Typical amplitude for signal outputs, inter-axis amplitude deviation, and polarity difference

- Test condition 4 (CP mode)
- Input : X In1
Test signal 3

Input signals (0.7V_{p-p}) including black and white levels at input A (X In1).

Measure the amplitudes between the black and white waveform levels at output pins (pin 21 when X=B, pin 19 when X=G, and pin 14 when X=R) for positive and negative polarities. Repeat this measurement replacing B, G, and R as the X-axis.

(Note 5) Maximum amount of contrast adjustment, inter-axis deviation

- Test condition 4 (CP mode)
- Input : X In1
Test signal 3
- VR₃₃ : Max (pin 33←5V)

Change SW₃₃ from a to b, and adjust VR₃₃ until 5V is applied to pin 33. Input a signal (0.7V_{p-p}) including black and white levels at input A. Measure the amplitudes between the black and white waveform levels at output terminals (pin 21 when X=B, pin 19 when X=G, and pin 14 when X=R). Calculate their ratio with the typical signal output amplitude and express it in dB units. Repeat this measurement replacing B, G, and R as the X-axis.

(Note 6) Typical amount of brightness adjustment, inter-axis deviation

- Test condition 4 (CP mode)
- Input : X In1
Test signal 3

Input a signal ($0.7V_{p-p}$) including black and white levels to input A.

Measure the voltage difference between the black and $\gamma 0$ waveform levels for an output pin (pin 21 when X=B, pin 19 when X=G, and pin 14 when X=R) for positive and negative polarities.

Repeat this measurement replacing B, G, and R as the X-axis.

(Note 7) Maximum amount of brightness adjustment, inter-axis difference

- Test condition 4 (CP mode)
- Input : X In1
Test No. 3
- VR27 : Max (pin 27 \leftarrow 0V)

Change SW₂₇ from OFF to ON, and adjust VR27 until 0V is applied to pin 27.

Input a signal ($0.7V_{p-p}$) including black and white levels in input A (X In1).

Measure the voltage difference between the black and $\gamma 0$ waveform levels for an output pin (pin 21 when X=B, pin 19 when X=G, and pin 14 when X=R).

Repeat this measurement replacing B, G, and R as the X-axis.

(Note 8) Minimum amount of brightness adjustment

- Test condition 4 (CP mode)
- Input : X In1
Test signal 3

Change SW₂₇ from OFF to ON, and adjust VR27 until 5V is applied to pin 27. Input a signal ($0.7V_{p-p}$) including black and white levels to input A (X In1).

Measure the voltage difference between black and $\gamma 0$ waveform levels for an output pin (pin 21 when X=B, pin 19 when X=G, and pin 14 when X=R).

Repeat this measurement replacing B, G, and R as the X-axis.

(Note 9) Typical cut-off level, inter-axis deviation

- Test condition 4 (CP mode)
- Input : X In1
Test signal 3

Input a signal ($0.7V_{p-p}$) including black and white levels to input A (X In1).

Measure the voltage difference between the $\gamma 0$ levels of the positive and negative polarity outputs in an output pin (pin 21 when X=B, pin 19 when X=G, and pin 14 when X=R).

Repeat this measurement replacing B, G, and R as the X-axis.

(Note 10) Maximum range of cut-off adjustment, inter-axis deviation

- Test condition 4 (CP mode)
- Input : X In1
Test signal 3
- VR25 : Max (pin 25←0V)

Change SW₂₅ from OFF to ON, and adjust VR25 fully until 0V is applied to pin 25.

Input a signal (0.7V_{p-p}) including black and white levels to input A (X In1).

Measure the voltage difference between the γ_0 level of the positive output and that of the negative output in an output pin (pin 21 when X=B, pin 19 when X=G, and pin 14 when X=R).

Repeat this measurement replacing B, G, and R as the X-axis.

(Note 11) Minimum range of cut-off adjustment, inter-axis deviation

- Test condition 4 (CP mode)
- Input : X In1
Test signal 3
- VR25 : Min (pin 25←5V)

Change SW₂₅ from OFF to ON, and adjust VR25 fully until 5V can be applied to pin 25.

Input a signal (0.7V_{p-p}) including black and white levels to input A (X In1).

Measure the voltage difference between the γ_0 level of the positive output and that of the negative output in an output pin (pin 21 when X=B, pin 19 when X=G, and pin 14 when X=R).

Repeat this measurement replacing B, G, and R as the X-axis.

(Note 12) Maximum cut-off fine adjustment range value, inter-axis deviation

- Test condition 4 (CP mode)
- Input : X In1 (X=B or R)
Test signal 3

X=B : VR26 : Min / Max (pin 26←0V / 5V)

X=R : VR24 : Min / Max (pin 24←0V / 5V)

When measuring channel B (X=B), change SW₂₆ from OFF to ON, and input a signal (0.7V_{p-p}) including black and white levels in input A (B In1). Turn VR26 clockwise and anticlockwise and measure the maximum value (when pin 26=5V and pin 26=0V) of the voltage difference from the γ_0 levels of the positive and negative polarity outputs of an output pin (pin 21). Obtain the voltage difference from the No. 15 standard cut-off level of each voltage.

For channel R (X=R), change SW₂₄ from OFF to ON, turn VR24 clockwise and anticlockwise, and make the same measurement as for channel B with output pin (14) using R In1 as the input pin.

(Note 13) Maximum value of drive output amplitude adjustment, inter-axis deviation

- Test condition 4 (CP mode)
- Input : X In1
Test signal 3
- VR29 : →Max

Change SW₂₅ from a to b, and adjust VR25 until 0V is applied to pin 25. Input a signal (0.7V_{p-p}) including black and white levels in input A (X In1). Change SW₂₉ from a to b, raise the voltage applied to pin 29 by adjusting VR29, and measure the amplitude value when the waveform amplitude stops increasing from the black to the white level for an output pin (pin 21 when X=B, pin 19 when X=G, and pin 14 when X=R) for positive and negative polarity outputs.

(Note 14) Minimum value of drive output amplitude adjustment, inter-axis deviation

- Test condition 4 (CP mode)
- Input : X In1
Test signal 3
- VR29 : →Min

Input a signal (0.7V_{p-p}) including black and white levels in input A (X In1). Change SW₂₉ from a to b, lower the voltage applied to pin 29 by adjusting VR29, and measure the amplitude value when the waveform amplitude stops decreasing from the black to the white level at an output pin (pin 21 when X=B, pin 19 when X=G, and pin 14 when X=R) in positive and negative polarity outputs.

(Note 15) Maximum and minimum drive fine adjustment values, inter-axis deviation

- Test condition 4 (CP mode)
- Input : X In1 (X=B or R)
Test signal 3

X=B : VR28 : Min / Max (pin 28←0V / 5V)

X=R : VR30 : Min / Max (pin 30←0V / 5V)

When measuring channel B, change SW₂₈ from OFF to ON, and input a signal (0.7V_{p-p}) including white and black levels in input A (B In1).

Turn VR28 clockwise and anticlockwise and measure the maximum value (when pin 28=5V) and the minimum value (on condition of pin 28=0V) of the voltage difference between the black and the white level of an output pin (pin 21). Obtain the ratio between the black and white levels of the output pin (pin 19) of each voltage.

When measuring channel P (X=R), change SW₃₀ from OFF to ON, and take the same measurement as for the channel B for an output pin (pin 14) by turning VR30 clockwise and anticlockwise, with R In1 as the input pin.

(Note 16) Signal frequency characteristics, inter-axis deviation

- Test condition 5 (CP mode, fixed polarity)
- Input : X In1
Test signal 2 (sweep)

Input test signal 2 to X In1, raise its frequency from 500kHz to 20MHz, and observe the amplitudes of the frequency components. Measure the frequency for a 3dB fall in output amplitude. Take the same measurements as for positive polarity by changing SW_{7B} from a to b.

(Note 17) Output dynamic range

- Test condition 4 (CP mode)
- Input : X In1
Test signal 3
- VR23 : →Max/Min

Input a signal (0.7V_{p-p}) including black and white levels to input A (X In1). Change SW₂₃ from a to b, raise and lower the voltage applied to pin 23 by turning VR23 clockwise and anticlockwise, measure the maximum and minimum black waveform levels for an output pin (pin 21 when X=B, pin 19 when X=g, and pin 14 when X=R), and thus obtain the voltage difference.

(Note 18) Signal output through-rate

- Test condition 4 (CP mode)
- Input : X In1
Test signal 5

Input to input A (X In1) a test signal whose 10 to 90% rise / fall times are less than 50ns in a rectangular waveform that repeats black and white levels. Measure the 10 to 90% rise / fall times in the waveform of the output pin (pin 21 when X=B, pin 19 when X=G, and pin 14 when X=R), and convert this to a through-rate.

(Note 19) Signal output S / N

- Test condition 5 (CP mode, fixed polarity)
- Input : no signal
Noise measurement band DC to 6MHz

Change SW₂₇ from a to b, and adjust VR27 while looking at the waveform of an output pin (pin 21, pin 19, pin 14) so that the difference between the $\gamma 0$ and black levels becomes 0. Measure the noise voltage (measurement band: ~6MHz) of the output pins in this state. Repeat this measurement for each output pin. Calculate the ratio of the No. 9 typical output amplitude to the measured noise voltage, and express it in dB units. For a positive polarity measurement, repeat the above measurement by changing SW_{7B} from a to b.

(Note 20) Reversed polarity center voltage, typical value, inter-axis deviation

- Test condition 4 (CP mode)
- Input : no signal

Measure the γ_0 levels of the positive and negative polarities of the output waveform at an output pin (pin 21 when X=B, pin 19 when X=G, and pin 14 when X=R), and measure the mean value of the two levels.

Repeat this measurement replacing B, G, and R as the X-axis.

(Note 21) Reversed polarity center voltage, maximum and minimum variable ranges, inter-axis deviation

- Test condition 4 (CP mode)
- Input : no signal
- VR23 : →Max/→Min

Change SW₂₅ from a to b, adjust VR26 and set the voltage applied to pin 25 at 5V, thereby minimizing the cut-off. Change SW₂₃ from a to b, raise and lower the voltage applied to pin 23 by turning VR23 clockwise and anticlockwise. Obtain the center voltage of the positive and negative γ_0 levels when the waveform of an output pin (pin 21 when X=B, pin 19 when X=G and pin 14 when X=R) approaches V_{DD} and stops rising, and set this as the maximum value. Obtain the center voltage of positive and negative γ_0 levels when the waveform of the output pin approaches GND and these levels stop decreasing, and make this voltage the minimum value.

Repeat this measurement replacing B, G, and R as the X-axis.

(Note 22) Typical γ characteristics, inter-axis deviation, polarity difference

- Test condition 4 (CP mode)
- Input : X In1
Test signal 3

Input test signal 3 including black, white, and 60% levels to input A (X In1). Measure the voltage difference (set at 1) between the white and black levels and the voltage difference (set at 2) between the 60% input and black levels in the waveform of an output pin (pin 21 when X=B, pin 19 when X=G, and pin 14 when X=R). Obtain a voltage difference ratio of 2:1. Repeat for the positive and negative polarity outputs.

Repeat this measurement replacing B, G, and R as the X-axis.

(Note 23) γ characteristic variable range, maximum and minimum-characteristic variable range, inter-axis deviation

- Test condition 4 (CP mode)
- Input : X In1
Test signal 3
- VR44 : Max / Min (pin 44 \leftarrow 0V / 5V)

Input test signal 3 including black, white, and 60% levels to input A (X In1). Change SW₄₄ from a to b, adjust VR44 and set the voltage applied to pin 44 at 0V, thereby maximizing the γ control. Measure the voltage difference (set to 1) between the white and black waveform levels for an output pin (pin 21 when X=B, pin 19 when X=G, and pin 14 when X=R) and the voltage difference (set at 2) between the 60% input and black levels. Obtain a voltage difference ratio of 2:1 and set this as the maximum value for the γ characteristics. Next, adjust VR44 in the opposite direction, set the voltage applied to pin 44 to 5V, and thus minimize the γ control. Obtain a voltage difference ratio of 2:1 as for the measurement of the maximum value, and set this as the minimum value of the γ characteristics. Repeat this measurement replacing B, G, and R as the X-axis.

(Note 24) γ fine adjustment characteristic variable range, maximum and minimum γ fine adjustment characteristic variable ranges, inter-axis deviation

- Test condition 4 (CP mode)
- Input : X In1 (X=B or R)
Test signal 3

X=B : VR43 : Max / Min (pin 43 \leftarrow 5V / 2.5V)

X=R : VR1 : Max / Min (pin 1 \leftarrow 5V / 2.5V)

When measuring channel B, change SW₄₃ from OFF to ON, and input test signal 3 including black, white, and 60% levels to input A (B In1). Turn VR43 fully, set the voltage applied to pin 43 at 5V, and thus maximize the γ control.

Measure the voltage difference (fixed at 1) between white and black waveform levels for output pin 21 and the voltage difference (fixed at 2) of 60% input and black levels. Obtain a voltage difference ratio of 2:1 and set this as the maximum value of the γ characteristics. Next, set the voltage applied to pin 43 to 2.5V by turning VR43 fully in the opposite direction, thereby minimizing the γ characteristics. Obtain a voltage difference ratio of 2:1 and thereby minimize the value of the γ characteristics in the same way the maximum value was measured. When measuring channel R (X=R) change SW₁ from OFF to ON, turn VR1 clockwise and anticlockwise with R In1 as the input pin, and thus measure output pin 14 in the same way as channel B.

(Note 25) Typical amplitude of common electrode signals

- Test condition 4
- Input : no signal

Measure the voltage difference between H and L levels in the output waveform of pin 10.

(Note 26) Amplitude of common electrode signals, maximum variable range, amplitude of common electrode signals, minimum variable range

- Test condition 4
- Input : no signal

Measure the voltage difference between H and L waveform levels for pin 10 output when terminal 11 is shorted to GND, and thus set this as the maximum amplitude.

Measure the voltage difference between the H and L levels for the output waveform of pin 10 when pin 11 is shorted with V_{CC} (%V), and set this as the minimum amplitude.

(Note 27) Typical common electrode signal center voltage

- Test condition 4
- Input : no signal

Obtain the mean value of H and L levels in the output waveform at pin 10 and set this as the center voltage.

(Note 28) Maximum and minimum common electrode signal center voltage variable ranges

- Test condition 4
- Input : no signal
- VR8 : →Max / →Min

Keep pin 11 shorted with V_{CC} (5V). Change SW₈ from OFF to ON, turn VR8 clockwise and anticlockwise and thus obtain the upper limit (maximum center voltage) and the lower limit (minimum center voltage) in a potential change at pin 10.

(Note 29) Common electrode signal output through-rate

- Test condition 4
- Input : no signal

Measure the 10 to 90% rise and fall times in the change between the H and L levels for the output waveform of pin 10, and convert these into through-rates.

(Note 30) Clamp signal output, threshold 1

- Test condition 6

Adjust VR34 and VR40 so that the voltage at pins 34 and 40 becomes 0.9V. Gradually raise from 0V the direct current voltage applied to CP A In (pin 3), and measure the voltage at CP A In when the normal voltage of $9.0 \pm 0.4V$ is output from G output pin (pin 19). Change SW_{2M} from a to b, and make similar measurements for CP B In (pin 4).

(Note 31) Clamp signal input threshold 2

- Test condition 4 (CP mode)
- Input : no signal

Change to DC the CP that is applied to CP A In (pin 3), gradually raise its voltage from 2.5V, and measure the voltage at CP A In (pin 3) when the voltage of channel A G input pin (pin 3) is clamped at $0.9 \pm 0.1V$. Change SW_{2B} from a to b, and make similar measurements for CP B In (pin 4), at channel B G input pin (pin 40).

(Note 32) Input-switching signal threshold

- Test condition 2 (direct coupling mode)
- Input : no signal

Adjust VR34 and VR40 so that the voltage of pin 34 is 0.9V and that of pin 40 at 1.6V. Change SW_{2A} from a to b, gradually raise from 0V the DC voltage at A/B Select (pin 2), and measure the pin 2 voltage when the output signal of G output pin 19 changes from the white level to the black level. (Voltage difference from the $\gamma 0$ level must be within 0.4V.)

(Note 33) Reversed polarity signal threshold

- Test condition 5 (CP mode, fixed polarity)
- Input : no signal

Change SW_{7A} from a to b, gradually raise from 0V the DC voltage applied at Pol In pin (7), and measure the pin 7 voltage when the output voltage of G output pin 19 exceeds 6.5V (rapidly rising from about 4V to about 9V).

(Note 34) Reversed polarity phase-switching signal threshold

- Test condition 5 (CP mode, fixed polarity)
- Input : no signal

Change SW_{6A} from a to b, gradually raise from 0V the DC voltage applied at pin 6, and measure the pin 6 voltage at the time the output voltage of G output pin 19 exceeds 6.5V (rapidly rising from about 4V to about 9V).

ELECTRICAL CHARACTERISTICS

List of Setup Test Condition

Test Condition 1 (no signal, non-operative)	PIN / FUNCTION	1	2	3	4	6	7	8	11	23	24	25	26	27
	SW / VR	γ -R Cont.	A / B Select	CP A In	CP B In	V Inv.	Pol In	Comm Cent.	Comm AMP	V ₀ Cent.	R Cutoff	Com Cutoff	B Cutoff	Brightness
	SW A	OFF	a	b	b	a	b	OFF	OFF	OFF	OFF	OFF	OFF	OFF
	SW B		a	a	a	a	a							
	VR SIG													
	PIN / FUNCTION	28	29	30	32	33	34	36	38	40	42	43	44	
	SW / VR	B Drive	Com Drive	R Drive	B In1	Con-tast	G In1	R In1	B In2	G In2	R In2	γ -B Cont.	γ -Com Cont.	
	SW A	OFF	a	OFF	a	a	ON	a	a	ON	a	OFF	OFF	
	SW B				OFF		OFF	OFF	OFF	OFF	OFF			
	VR SIG													
Test Condition 2 (DC coupling, typical operation)	PIN / FUNCTION	1	2	3	4	6	7	8	11	23	24	25	26	27
	SW / VR	γ -R Cont.	A / B Select	CP A In	CP B In	V Inv.	Pol In	Comm Cent.	Comm AMP	V ₀ Cent.	R Cutoff	Com Cutoff	B Cutoff	Brightness
	SW A	OFF	a	b	b	a	b	OFF	OFF	OFF	OFF	OFF	OFF	OFF
	SW B		a	a	a	a	a							
	VR SIG			<u>CP1</u>	<u>CP1</u>		<u>POL</u>							
	PIN / FUNCTION	28	29	30	32	33	34	36	38	40	42	43	44	
	SW / VR	B Drive	Com Drive	R Drive	B In1	Con-tast	G In1	R In1	B In2	G In2	R In2	γ -B Cont.	γ -Com Cont.	
	SW A	OFF	a	OFF	<u>b</u>	a	ON	<u>b</u>	<u>b</u>	ON	<u>b</u>	OFF	OFF	
	SW B				OFF		<u>ON</u>	OFF	OFF	<u>ON</u>	OFF			
	VR SIG						(SIG)			(SIG)				

Test Condition 3 (DC coupling, fixed polarity)	PIN / FUNCTION	1	2	3	4	6	7	8	11	23	24	25	26	27
	SW / VR	γ -R Cont.	A/B Select	CP A In	CP B In	V Inv.	Pol In	Comm Cent.	Comm AMP	V ₀ Cent.	R Cutoff	Com Cutoff	B Cutoff	Brightness
	SW A	OFF	a	b	b	a	<u>a</u>	OFF	OFF	OFF	OFF	OFF	OFF	OFF
	SW B		a	a	a	a	a							
	VR SIG			<u>CP1</u>	<u>CP1</u>									
	PIN / FUNCTION	28	29	30	32	33	34	36	38	40	42	43	44	
	SW / VR	B Drive	Com Drive	R Drive	B In1	Con-tast	G In1	R In1	B In2	G In2	R In2	γ -B Cont.	γ -Com Cont.	
	SW A	OFF	a	OFF	<u>b</u>	a	ON	<u>b</u>	<u>b</u>	ON	<u>b</u>	OFF	OFF	
	SW B				OFF		<u>ON</u>	OFF	OFF	<u>ON</u>	OFF			
	VR SIG						(SIG)			(SIG)				
Test Condition 4 (clamp, typical operation)	PIN / FUNCTION	1	2	3	4	6	7	8	11	23	24	25	26	27
	SW / VR	γ -R Cont.	A/B Select	CP A In	CP B In	V Inv.	Pol In	Comm Cent.	Comm AMP	V ₀ Cent.	R Cutoff	Com Cutoff	B Cutoff	Brightness
	SW A	OFF	a	b	b	a	b	OFF	OFF	OFF	OFF	OFF	OFF	OFF
	SW B		a	a	a	a	a							
	VR SIG			<u>CP2</u>	<u>CP2</u>		<u>POL</u>							
	PIN / FUNCTION	28	29	30	32	33	34	36	38	40	42	43	44	
	SW / VR	B Drive	Com Drive	R Drive	B In1	Con-tast	G In1	R In1	B In2	G In2	R In2	γ -B Cont.	γ -Com Cont.	
	SW A	OFF	a	OFF	a	a	ON	a	a	ON	a	OFF	OFF	
	SW B				OFF		OFF	OFF	OFF	OFF	OFF			
	VR SIG				(SIG)		(SIG)	(SIG)	(SIG)	(SIG)	(SIG)			

Test Condition 5 (clamp, fixed polarity)	PIN / FUNCTION	1	2	3	4	6	7	8	11	23	24	25	26	27
	SW / VR	γ -R Cont.	A / B Select	CP A In	CP B In	V Inv.	Pol In	Comm Cent.	Comm AMP	V ₀ Cent.	R Cutoff	Com Cutoff	B Cutoff	Brightness
	SW A	OFF	a	b	b	a	<u>a</u>	OFF	OFF	OFF	OFF	OFF	OFF	OFF
	SW B		a	a	a	a	a							
	VR SIG			<u>CP2</u>	<u>CP2</u>									
	PIN / FUNCTION	28	29	30	32	33	34	36	38	40	42	43	44	
	SW / VR	B Drive	Com Drive	R Drive	B In1	Con-tast	G In1	R In1	B In2	G In2	R In2	γ -B Cont.	γ -Com Cont.	
	SW A	OFF	a	OFF	a	tast	ON	a	a	ON	a	OFF	OFF	
	SW B				OFF		OFF	OFF	OFF	OFF	OFF			
	VR SIG				(SIG)		(SIG)	(SIG)	(SIG)	(SIG)	(SIG)			
Test Condition 6 (VTHcp)	PIN / FUNCTION	1	2	3	4	6	7	8	11	23	24	25	26	27
	SW / VR	γ -R Cont.	A / B Select	CP A In	CP B In	V Inv.	Pol In	Comm Cent.	Comm AMP	V ₀ Cent.	R Cutoff	Com Cutoff	B Cutoff	Brightness
	SW A	OFF	a	b	b	a	<u>a</u>	OFF	OFF	OFF	OFF	OFF	OFF	OFF
	SW B		a	a	a	a	a							
	VR SIG			<u>DC</u>	<u>DC</u>									
	PIN / FUNCTION	28	29	30	32	33	34	36	38	40	42	43	44	
	SW / VR	B Drive	Com Drive	R Drive	B In1	Con-tast	G In1	R In1	B In2	G In2	R In2	γ -B Cont.	γ -Com Cont.	
	SW A	OFF	a	OFF	<u>b</u>	a	ON	<u>b</u>	<u>b</u>	ON	<u>b</u>	OFF	OFF	
	SW B				OFF		<u>ON</u>	OFF	OFF	<u>ON</u>	OFF			
	VR SIG				(SIG)		(SIG)	(SIG)	(SIG)	(SIG)	(SIG)			

(Note 1) This setup is based on the initial setup condition before starting various measurements.

(Note 2) Symbols a, b, ON, and OFF show the SW setup.

(Note 3) The underlined setup shows that it is to be changed when the setup of test condition 1 is specified as default.

(Note 4) The signal names in the SIG column (CP1, CP2, POL...) show that the specified signals are applied on a fixed basis. (SIG) applies signals to any one pin according to items.

CONTROL SIGNAL AND TEST SIGNAL

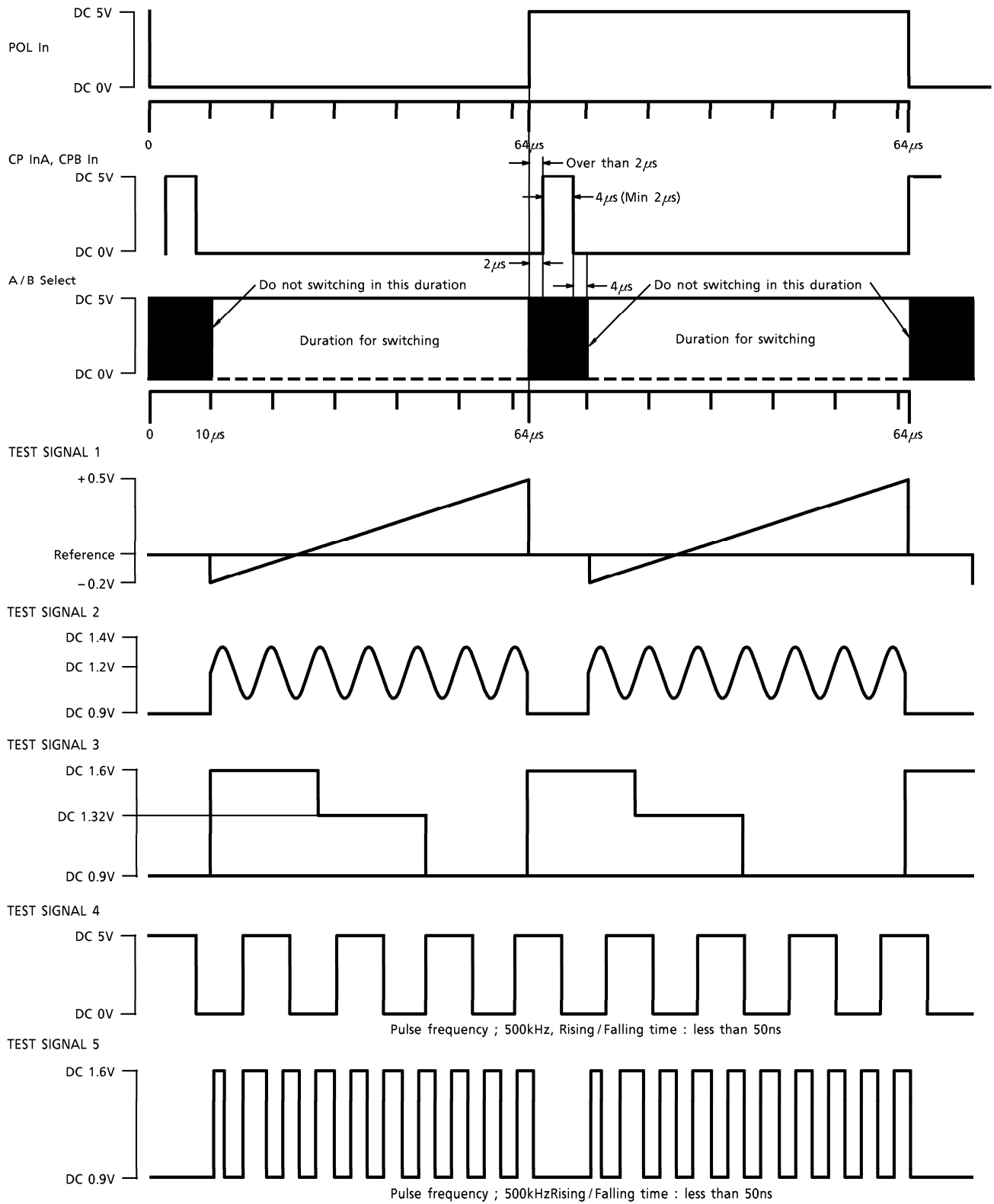

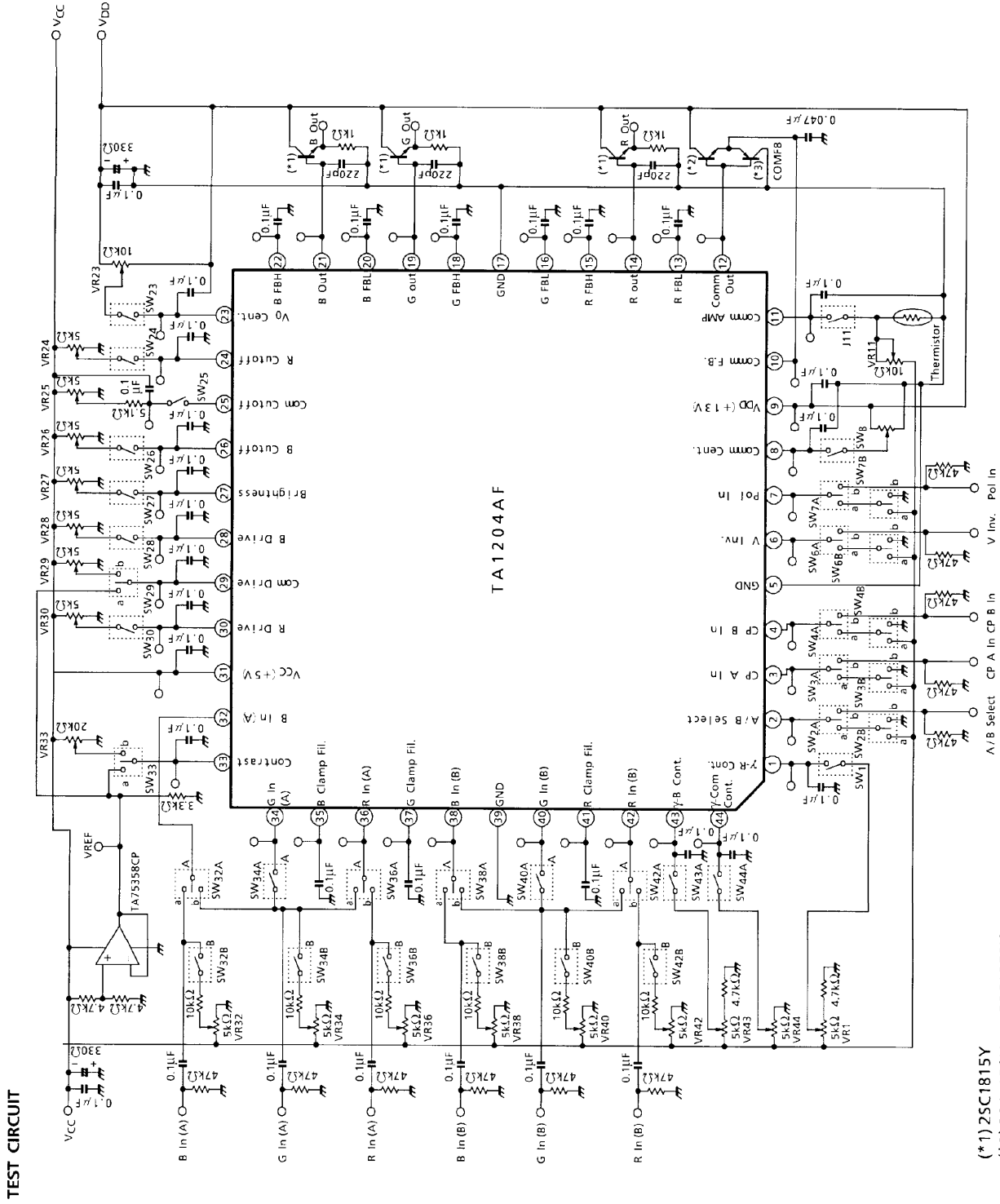

(*1) 25C1815Y
 (*2) 25C120Y or 25C1959Y
 (*3) 25A950Y or 25A562TM

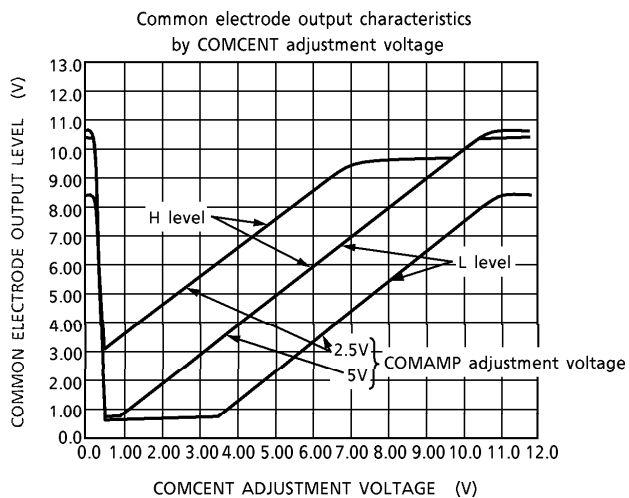
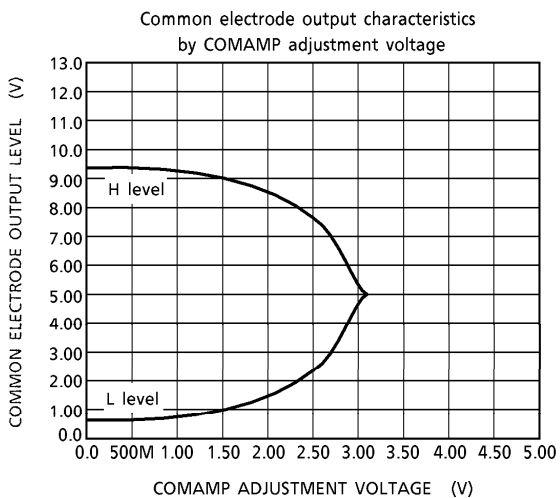

OUTLINE DRAWING
QFP44-P-1414-0.80B

Unit : mm

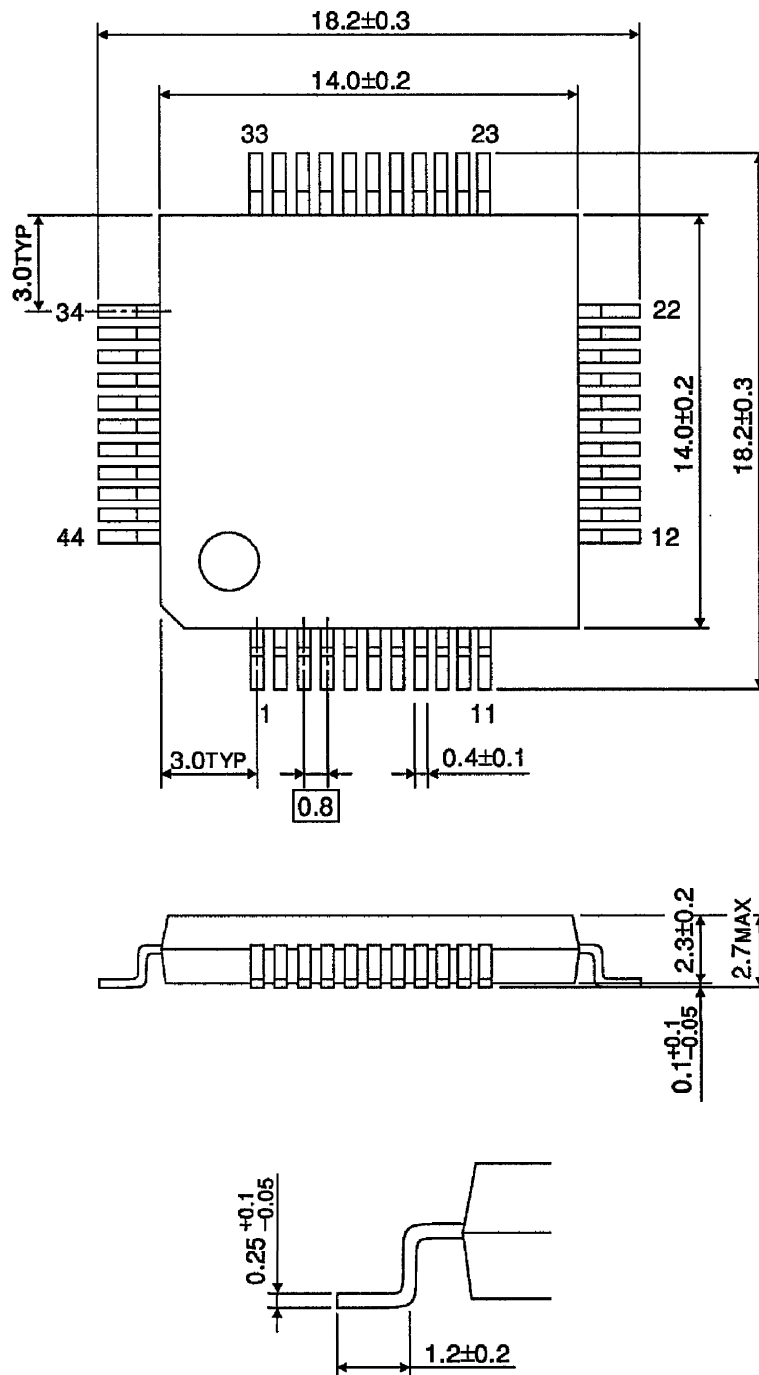

Weight : 1.15g (Typ.)