



MAX1585 Evaluation Kit

General Description

The MAX1585 evaluation kit is a fully assembled and tested circuit that accepts input voltages of 2.8V to 5V and provides all the output voltages required for a typical digital still camera. The outputs consist of the main step-up output (5V), a step-down output (1.5V), a general-purpose 3.3V output, +15V and -7.5V outputs for charge-coupled device (CCD) and LCD bias, and an optional general-purpose output using the MAX1801 slave controller.

Ordering Information

PART	TEMP RANGE	IC PACKAGE
MAX1585EVKIT	0°C to +70°C	32 Thin QFN 5mm x 5mm

Features

- ◆ Up to 95% Efficiency
- ◆ 2.8V to 5V Input Voltage Range
- ◆ Main Step-Up Output, 5V or Adjustable
- ◆ Step-Down Output, 1.5V or Adjustable
- ◆ 5V General-Purpose Output
- ◆ CCD and LCD Bias Outputs (+15V/-7.5V)
- ◆ Optional General-Purpose Output Using the MAX1801 Slave Controller
- ◆ 1µA Shutdown Mode
- ◆ Internal Soft-Start Control
- ◆ Overload Protection for All Outputs
- ◆ Fully Assembled and Tested

Component List

DESIGNATION	QTY	DESCRIPTION
C1	1	0.01µF ±10%, 16V X7R ceramic capacitor (0402) TDK C1005X7R1E103K or equivalent
C2	1	4700pF ±10%, 25V X7R ceramic capacitor (0402) TDK C1005X7R1E472K Taiyo Yuden TMK105BJ472KV or equivalent
C3, C5	2	1500pF ±10%, 50V X7R ceramic capacitors (0402) TDK C1005X7R1H152K Taiyo Yuden UMK105BJ152KV or equivalent
C4	1	470pF ±10%, 50V X7R ceramic capacitor (0402) Murata GRP155R71H471K or equivalent
C6	1	4.7µF ±20%, 25V X5R ceramic capacitor (1210) Taiyo Yuden TMK325BJ475MN
C7, C21	0	Not installed (1210)
C8	1	4.7µF ±20%, 10V X5R ceramic capacitor (1206) Taiyo Yuden LMK316BJ475ML
C9, C10, C17, C18, C19, C24, C27	7	10µF ±20%, 6.3V X5R ceramic capacitors (0805) Panasonic ECJ2FB0J106M or Taiyo Yuden JMK212BJ106MG

DESIGNATION	QTY	DESCRIPTION
C11, C13	2	47µF ±20%, 6.3V X5R ceramic capacitors (1812) Taiyo Yuden JMK432BJ476MM
C12	1	0.1µF ±10%, 16V X7R ceramic capacitor (0603) Taiyo Yuden EMK107BJ104KA or equivalent
C14	1	330pF ±5%, 50V C0G ceramic capacitor (0603) Murata GRM1885C1H331J
C15	0	Not installed (0402)
C16	0	Not installed (0805)
C20	1	560pF ±10%, 50V X7R ceramic capacitor (0402) Murata GRP155R71H561K
C22	0	Not installed 15pF ±5%, 50V C0G ceramic capacitor (0402) Murata GRP1555C1H150J or equivalent
C23	1	1µF ±20%, 10V X5R ceramic capacitor (0603) Taiyo Yuden JMK107BJ105MA
D1, D2, D3	3	Schottky diodes 500mA (SOD-123) Central CMHSH5-2L or IRF MBR0520
D4	1	Schottky diode 2.0A, 30V (SMA) Nihon EC21QS03L

Evaluates: MAX1584/MAX1585

MAX1585 Evaluation Kit

Evaluates: MAX1584/MAX1585

Component List (continued)

DESIGNATION	QTY	DESCRIPTION
D5, D7	0	Not installed (SOD-123)
D6	0	Not installed (SOD-123) Schottky diode 0.5A, 60V Nihon EP05Q06
JU1–JU5	5	3-pin headers
JU6, JU8, JU10, JU11, JU13, JU15	0	Not installed Cut here—short
JU7, JU9, JU12, JU14, JU16	0	Not installed Cut here—open
L1	1	5.0 μ H inductor Sumida CDRH6D38-5R0
L2	1	22 μ H inductor Sumida CDRH5D28-220
L3	1	2.0 μ H inductor Sumida CDRH4D28-2R0
L4	1	10 μ H inductor Sumida CDRH5D28-100
L5, L7	0	Not installed
L6	1	3.6 μ H inductor (D63LCB) TOKO A921CY-3R6M
N1	1	n-channel MOSFET (SOT23) Fairchild FDN337
N2	0	Not installed (6-pin SOT)
N3	0	Not installed (SOT23)
P1, P2	2	p-channel MOSFETs (SOT23) Fairchild FDN360P

DESIGNATION	QTY	DESCRIPTION
P3, P4	0	Not installed (SOT23)
R1	1	33.2k Ω \pm 1% resistor (0603)
R2	1	40.2k Ω \pm 1% resistor (0603)
R3	1	150k Ω \pm 1% resistor (0603)
R4	1	61.9k Ω \pm 1% resistor (0603)
R5	1	100k Ω \pm 5% resistor (0603)
R6	1	1M Ω \pm 1% resistor (0603)
R7, R11, R13	3	90.9k Ω \pm 1% resistors (0603)
R8	1	562k Ω \pm 1% resistor (0603)
R9	1	93.1k Ω \pm 1% resistor (0603)
R10, R15	2	18.2k Ω \pm 1% resistors (0603)
R12	1	274k Ω \pm 1% resistor (0603)
R14	1	30.1k Ω \pm 1% resistor (0603)
R16, R17, R18, R21, R23, R24, R25, R26	0	Not installed (0603)
R19	1	20k Ω \pm 1% resistor (0603)
R20	1	1M Ω \pm 5% resistor (0603)
R22	1	1.21k Ω \pm 1% resistor (0603)
T1	0	Not installed (CLQ72) transformer Sumida sample number: 6333-T500
U1	1	MAX1585ETJ (32-pin thin QFN 5mm x 5mm)
U2	0	Not installed (8-pin SOT23)
None	5	Shunts, 2-position
None	1	MAX1585 EV kit PC board

Component Suppliers

SUPPLIER	PHONE	WEBSITE
Central Semiconductor	631-435-1110	www.centrasemi.com
Fairchild Semiconductor	408-721-2181	www.fairchildsemi.com
International Rectifier	310-322-3331	www.irf.com
Kamaya	260-489-1533	www.kamaya.com
Murata	814-237-1431	www.murata.com
Panasonic	714-373-7939	www.panasonic.com
Sumida	847-956-0666	www.sumida.com
Taiyo Yuden	408-573-4150	www.t-yuden.com
TDK	847-803-6100	www.component.tdk.com
TOKO	847-297-0070	www.toko.com
Vishay	402-563-6866	www.vishay.com

MAX1585 Evaluation Kit

Evaluates: MAX1584/MAX1585

Quick Start

Required Equipment

- Power supply capable of supplying 5V at 3A
- Voltmeter
- Load resistors or electronic loads

Procedure

Follow the steps below to verify operation of the MAX1585 EV kit:

- 1) Preset the power supply to between 2.8V and 5V.
- 2) Turn off the power supply.
- 3) Connect the power supply positive lead to IN.
- 4) Connect the power supply ground lead to GND.
- 5) Connect loads from the outputs OUTSD, OUT1, OUT2B, and OUT3 to GND. See Table 1 for maximum load currents.
- 6) Verify that jumper JU1 has pins 2 and 3 shorted (to enable the main step-up output).
- 7) Verify that jumpers JU2–JU5 have pins 1 and 2 shorted (to disable other outputs).
- 8) Turn on the power supply.
- 9) Verify the OUTSU voltage (5V) using a voltmeter.
- 10) Connect a load, if desired, from OUTSU to GND (see Table 1 for maximum load currents).
- 11) To verify other outputs, move jumpers JU2–JU5 to short pins 2 and 3 to enable corresponding output, and verify the output voltages with a voltmeter (see Table 2).

Table 1. Output Voltages and Maximum Currents

OUTPUT	VOLTAGE (V)	MAXIMUM CURRENT (mA)
OUTSU	5.0	1000 (Note 1)
OUTSD	1.5	250
OUT1	15.0	130
OUT2B	-7.5	50
OUT3	3.3	300

Note 1: If OUT3 is operating and powered from OUTSU (JU8 shorted and JU7 open), subtract 70% of the OUT3 load current from the maximum load capability of OUTSU.

Detailed Description

Main Step-Up Output (OUTSU)

The main output (OUTSU) powers the internal circuitry of the MAX1585 and must reach its regulation voltage before any other output turns on. To enable OUTSU, short pins 2-3 of jumper JU1. When JU1 pins 1-2 are shorted, all outputs shut down and the IC is in low-current shutdown mode.

OUTSU is configured for 5V. If a different output voltage is desired, see the *Adjusting the Main Step-Up Output Voltage* section.

Short-Circuit Flag (SCF)

SCF is an open-drain output that is high impedance when overload protection occurs. Under normal operation SCF pulls low. In the default configuration there is a 1M Ω pullup resistor (R20) from SCF to OUTSU.

SCF can be used to drive a high-side p-channel MOSFET switch that disconnects the load from OUTSU during power-up or when a channel turns off in response to a logic command or an overload. See the *Optional OUTSU Load Disconnect* section.

Step-Down Output (OUTSD)

The step-down output (OUTSD) is set to 1.5V. To enable OUTSD, short pins 2-3 of jumper JU2. To shut down OUTSD, short pins 1-2 of JU2. To adjust the OUTSD output voltage, see the *Adjusting the Step-Down Output Voltage* section.

Step-Down OK ($\overline{\text{SDOK}}$)

The step-down OK output ($\overline{\text{SDOK}}$) is an open-drain output that pulls low after the step-down converter has successfully completed soft-start. $\overline{\text{SDOK}}$ goes high impedance in shutdown, overload, and thermal limit. For more details on $\overline{\text{SDOK}}$, refer to the MAX1584/MAX1585 data sheet.

Auxiliary Output 1 (OUT1)

OUT1 is a regulated 15V output. To enable OUT1, connect pins 2-3 of jumper JU3. To shut down OUT1, short pins 1-2 of JU3. If an output voltage other than 15V is desired, see the *Adjusting the OUT1 Voltage* section.

Auxiliary Output 1 OK ($\overline{\text{AUX1OK}}$)

$\overline{\text{AUX1OK}}$ is an open-drain output that pulls low when OUT1 has successfully completed soft-start. $\overline{\text{AUX1OK}}$ goes high impedance in shutdown, overload, and thermal limit.

MAX1585 Evaluation Kit

Table 2. Jumper Functions

JUMPER	SHORT PINS 1-2	SHORT PINS 2-3
JU1	All outputs are shut down	OUTSU enabled
JU2	OUTSD shut down	OUTSD enabled
JU3	OUT1 shut down	OUT1 enabled
JU4	OUT2 shut down	OUT2 enabled
JU5	OUT3 shut down	OUT3 enabled

Auxiliary Output 2 (OUT2B)

OUT2B is a regulated -7.5V output. To enable OUT2B, short pins 2-3 of JU4. To shut down OUT2B, short pins 1-2 of JU4. If a different output voltage is desired, see the *Adjusting the OUT2B Voltage* section.

When using the MAX1584, auxiliary output 2 can be configured as a step-up converter (OUT2A) or as a transformer flyback circuit providing two outputs (OUT2A and OUT2B). See the *Evaluating the MAX1584* section.

Auxiliary Output 3 (OUT3)

OUT3 is a regulated 3.3V output. To enable OUT3, short pins 2-3 of JU5. To shut down OUT3, short pins 1-2 of JU5. If a different output voltage is desired, see the *Adjusting the OUT3 Voltage* section.

Customizing the MAX1585 Evaluation Kit

Changing the Switching Frequency

The switching frequency of the MAX1585 is adjustable. Typically, frequencies from 400kHz to 600kHz provide a good compromise between efficiency and compo-

nent size. To change the frequency, replace C14 and R19. Refer to the MAX1584/MAX1585 data sheet for information on selecting values for these components.

Adjusting the Main Step-Up Output Voltage

The main step-up output (OUTSU) can be adjusted from 2.7V to 5.5V using the following procedure:

- 1) Select a value for R13 between 10kΩ and 100kΩ.
- 2) Solve for R12 using:

$$R_{12} = R_{13} [(V_{OUTSU} / 1.25) - 1]$$
- 3) Replace R12 and R13 with the new value resistors.
- 4) For best performance, it may be necessary to change the inductor, output capacitor, and compensation components. Refer to the MAX1584/MAX1585 data sheet.

Optional OUTSU Load Disconnect

SCF can be used to drive a high-side p-channel MOSFET switch that disconnects the load from OUTSU during power-up or when a channel turns off in response to a logic command or an overload. To configure the EV kit for this feature, install p-channel MOSFET P3 and cut the trace shorting JU13.

Similarly, $\overline{AUX10K}$ can also drive a high-side p-channel MOSFET to disconnect the load from OUTSU when OUT1 is out of regulation. To utilize this feature, install p-channel MOSFET P3, cut the traces shorting JU11 and JU13, and short JU12.

Table 3. PC Board Jumper Functions

JUMPER	DEFAULT	FUNCTION
JU6	Short	Connects the ground planes together. This must remain shorted for proper circuit operation.
JU7	Open	Select the input power for the auxiliary 3 converter. Short only one of these jumpers. Short JU7 to connect the auxiliary 3 input power to IN, or short JU8 to connect to OUTSU.
JU8	Short	
JU9	Open	Select the input power for the step-down converter. Short only one of these jumpers. Short JU9 to connect the step-down input power to OUTSU, or short JU10 to connect to IN.
JU10	Short	
JU11	Short	Select which signal controls the optional power sequencing of OUTSU. JU11 is for SCF and JU12 is for $\overline{AUX10K}$. Short only one of these jumpers. See the <i>Optional OUTSU Load Disconnect</i> section.
JU12	Open	
JU13	Short	Shorts the optional MOSFET that controls power sequencing for OUTSU. Open JU13 and install P3 if OUTSU power sequencing is used; otherwise, leave JU13 shorted. See the <i>Optional OUTSU Load Disconnect</i> section.
JU14	Open	Allow the CC3 compensation components to be connected to either ground (JU14) or FB3 (JU15). Short only one of these jumpers.
JU15	Short	
JU16	Open	Selects topology for auxiliary output 2 with the MAX1584. Short for step-up, or leave open for transformer flyback. See the <i>Evaluating the MAX1584</i> section.

MAX1585 Evaluation Kit

Evaluates: MAX1584/MAX1585

Adjusting the Step-Down Output Voltage

The step-down output voltage (OUTSD) can be set from 1.25V to V_{OUTSU} using the following procedure:

- 1) Select a value for R11 between 10k Ω and 100k Ω .
- 2) Solve for R10 using:
$$R10 = R11 [(V_{OUTSD} / 1.25) - 1]$$
- 3) Replace R10 and R11 with the new value resistors.
- 4) For best performance, it may be necessary to change the inductor, output capacitor, and compensation components. Refer to the MAX1584/MAX1585 data sheet.

Adjusting the OUT1 Voltage

The output voltage of OUT1 is preset to 15V, but is adjustable to voltages greater than 1.25V by changing two resistors. Note that if the input voltage is greater than the regulation voltage for OUT1, V_{OUT1} will rise above its regulation voltage to one diode drop lower than the input voltage. Use the following procedure to set V_{OUT1} :

- 1) Select a value for R7 between 10k Ω and 100k Ω .
- 2) Solve for R6 using:
$$R6 = R7 [(V_{OUT1} / 1.25) - 1]$$
- 3) Replace R6 and R7 with the new value resistors.
- 4) For best performance, it may be necessary to change the inductor, output capacitor, and compensation components. Refer to the MAX1584/MAX1585 data sheet.

Adjusting the OUT2B Voltage

OUT2B is a negative voltage that is adjusted using two resistors. Use the following procedure to set V_{OUT2B} :

- 1) Select a value for R9 between 10k Ω and 100k Ω .
- 2) Solve for R8 using:
$$R8 = R9 (-V_{OUT2B} / 1.25)$$
- 3) Replace R8 and R9 with the new value resistors.
- 4) For best performance, it may be necessary to change the inductor, output capacitor, and compensation components. Refer to the MAX1584/MAX1585 data sheet.

Adjusting the OUT3 Voltage

The output voltage of OUT3 is preset to 3.3V but is adjustable to voltages greater than 1.25V by changing two resistors. Note that if the input voltage is greater than the regulation voltage for OUT3, OUT3 will rise above its regulation voltage by one diode drop lower than the input voltage. To select OUT3 voltage-setting resistors, refer to the MAX1584/MAX1585 data sheet.

Optional Auxiliary Controller 3 Power Sequencing (OUT3SW)

The OUT3SW output optionally switches to OUT3 after the step-down converter has powered up. To use OUT3SW, install P4 and R2. OUT3SW power sequencing is controlled by \overline{SDOK} .

Optional Step-Up Controller (OUT4)

A MAX1801 step-up slave controller can be used with the MAX1585 EV kit to generate an additional output. To use this feature, install a MAX1801 in U2 on the solder side of the PC board. Free samples of the MAX1801 can be obtained from Maxim. Also install components N4, D6, L5, C15, C16, R16, R17, and R18. Refer to the MAX1801 data sheet for information on selecting these components.

Evaluating the MAX1584

The MAX1584 can be evaluated on the MAX1585 evaluation kit with auxiliary controller 2 configured as either a step-up converter or transformer flyback. To evaluate the MAX1584, carefully remove the IC and replace with the MAX1584. Then remove the components used in the MAX1585's auxiliary 2 inverter (P1, D2, L6, R8, R9, and C8). If using auxiliary 2 as a step-up, short JU16. Make sure JU16 is open if using a transformer. Finally install the components for the desired configuration of auxiliary 2. Refer to the MAX1584/MAX1585 data sheet for information on component selection.

MAX1585 Evaluation Kit

Evaluates: MAX1584/MAX1585

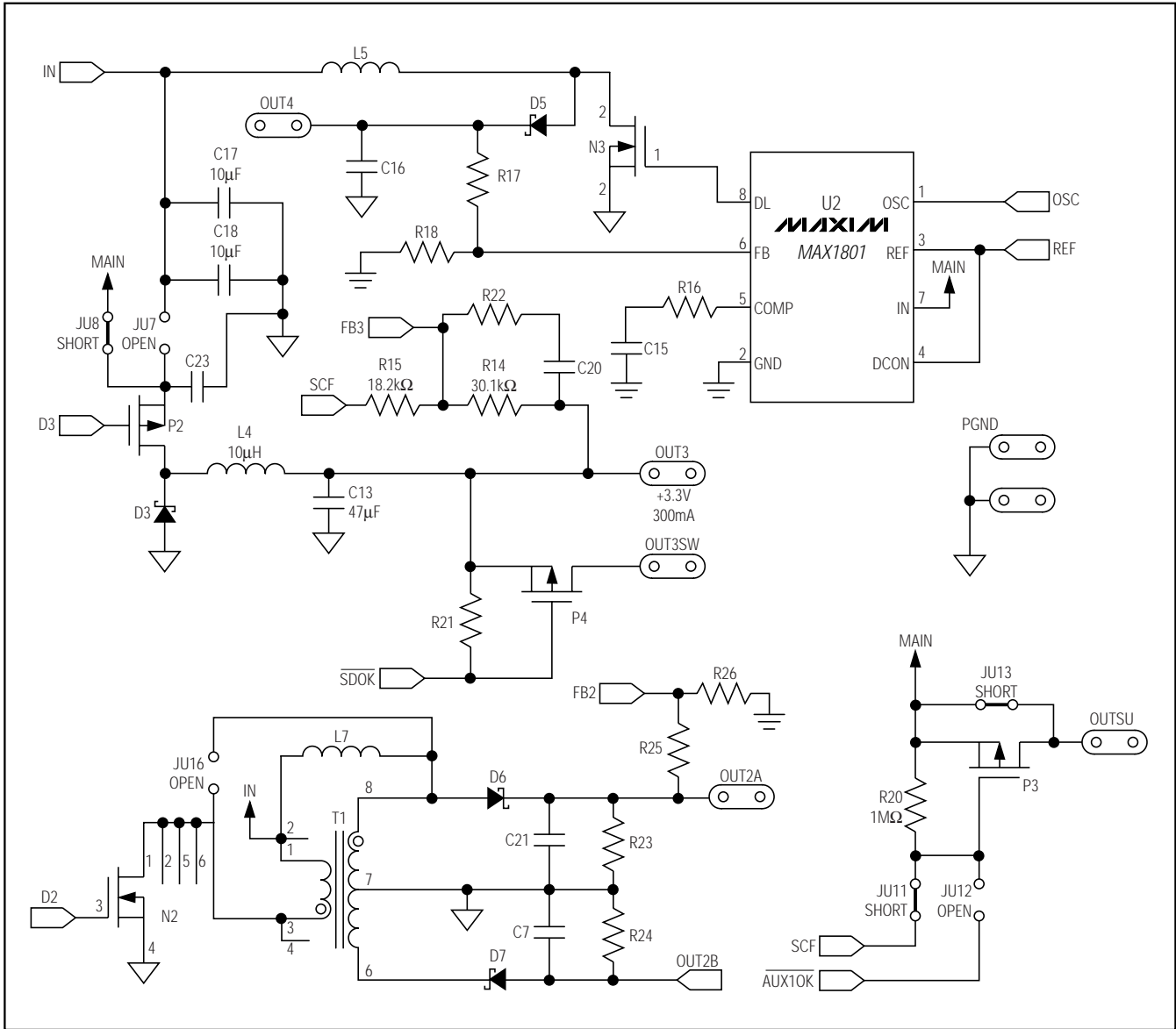

Figure 1. MAX1585 EV Kit Schematic (Sheet 2 of 2)

MAX1585 Evaluation Kit

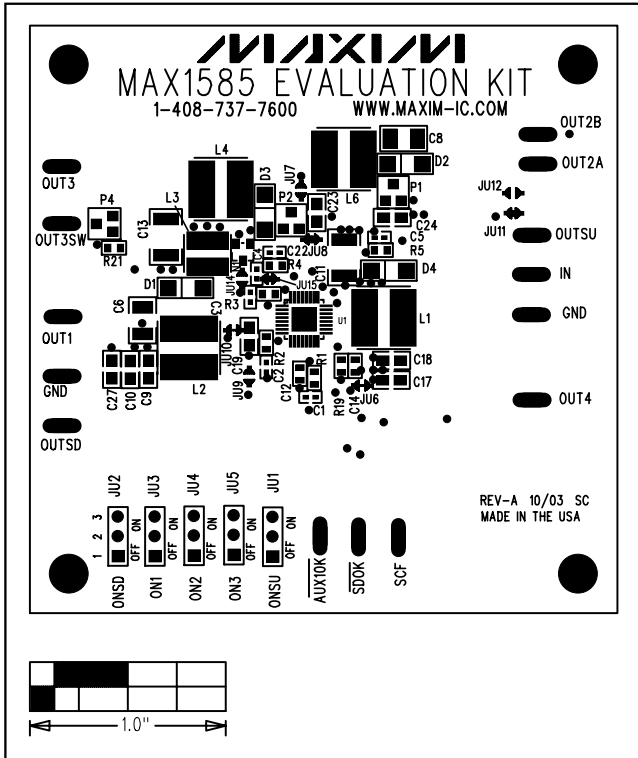

Figure 2. MAX1585 EV Kit Component Placement—Component Side

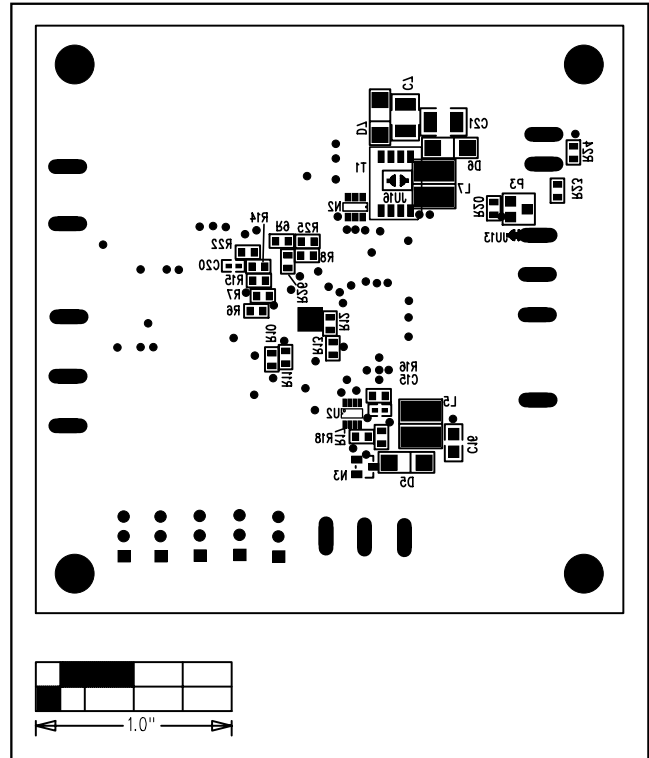

Figure 3. MAX1585 EV Kit Component Placement—Solder Side

MAX1585 Evaluation Kit

Evaluates: MAX1584/MAX1585

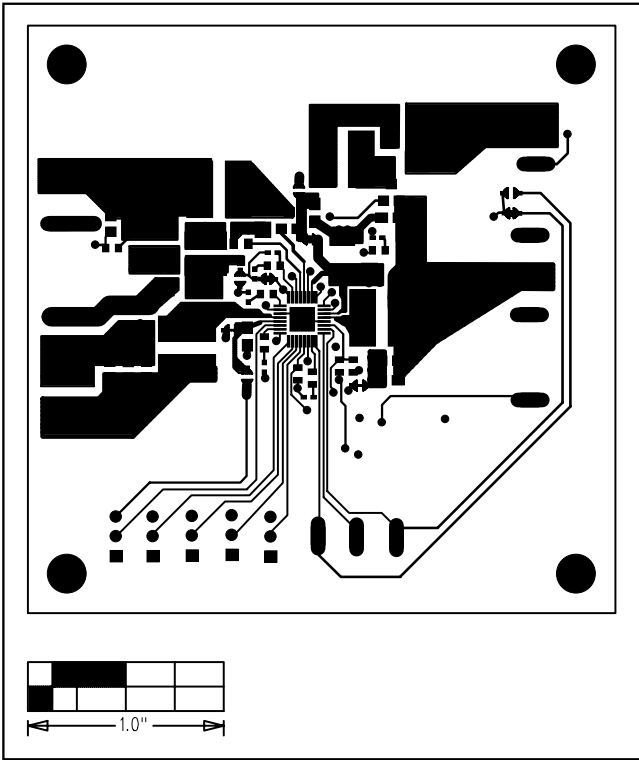

Figure 4. MAX1585 EV Kit PC Board Layout—Component Side

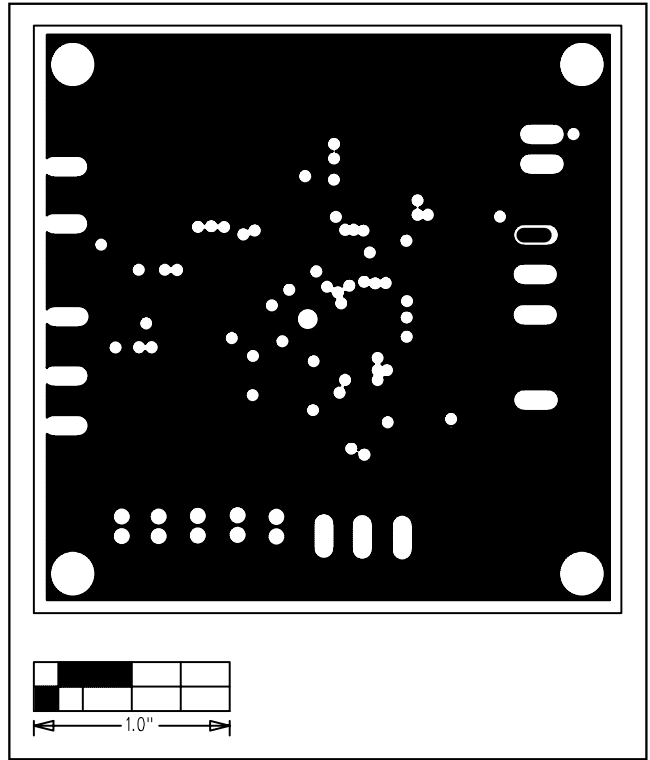

Figure 5. MAX1585 EV Kit PC Board Layout—Inner Layer 2

MAX1585 Evaluation Kit

Evaluates: MAX1584/MAX1585

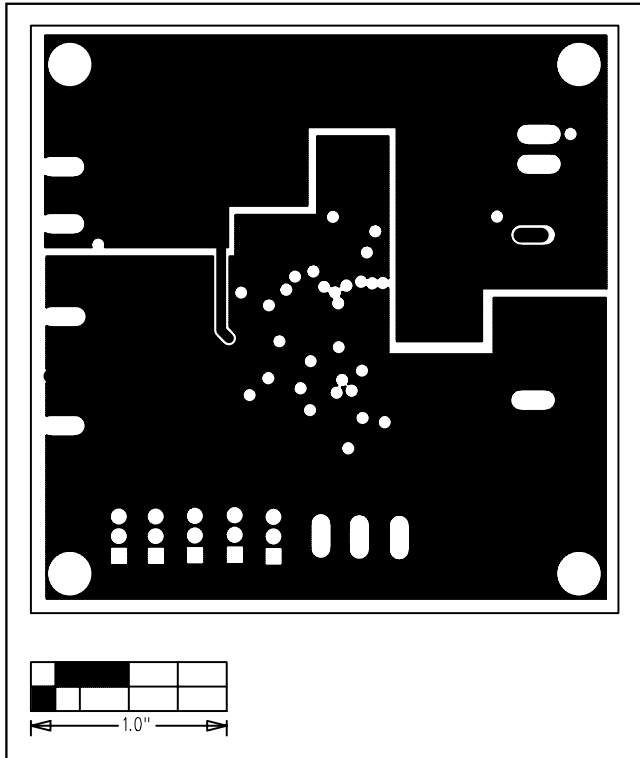

Figure 6. MAX1585 EV Kit PC Board Layout—Inner Layer 3

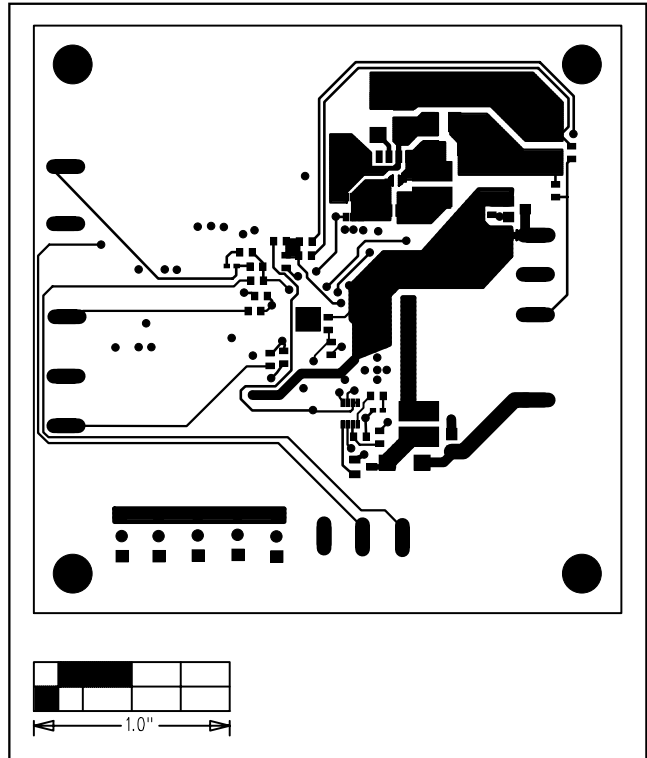

Figure 7. MAX1585 EV Kit PC Board Layout—Solder Side

Maxim cannot assume responsibility for use of any circuitry other than circuitry entirely embodied in a Maxim product. No circuit patent licenses are implied. Maxim reserves the right to change the circuitry and specifications without notice at any time.

10 _____ Maxim Integrated Products, 120 San Gabriel Drive, Sunnyvale, CA 94086 408-737-7600