

# AN1358 (AN6562), AN1358S (AN6562S)

## Dual Operational Amplifiers

### Overview

The AN1358 (AN6562) and AN1358S (AN6562S) are dual operational amplifiers with two phase compensation circuits built-in, have a wide range of operating supply voltage, and can operate on a single power supply.

They have electrical characteristics equivalent to those of the conventional operational amplifiers, and are low-powered and suitable for application to various circuits.

Note) The type numbers in ( ) are old ones.

### Features

- Built-in phase compensation circuits
- Wide range of input voltage : 0V to  $V_{CC} - 1.5V$
- Wide range of operating supply voltage :  
Single power supply : 3 to 30V  
Dual power supply :  $\pm 1.5$  to  $\pm 15V$

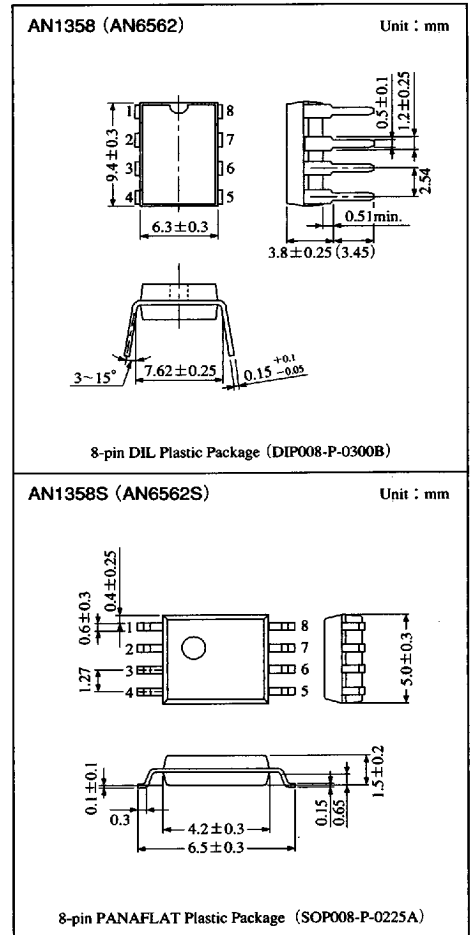

### Block Diagram

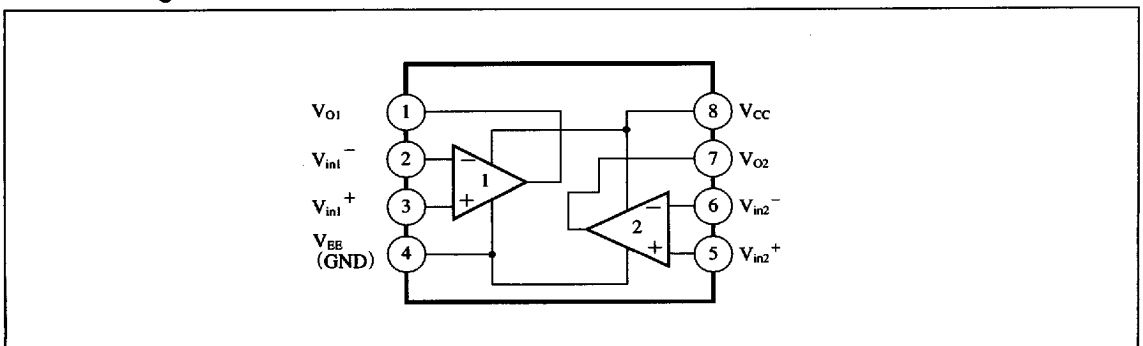

6932852 0012380 614

Panasonic

### Absolute Maximum Ratings (Ta=25°C)

Parameter	Symbol	Rating	Unit
Supply voltage	V <sub>CC</sub>	32	V
Differential input voltage	V <sub>ID</sub>	32	V
Common-mode input voltage	V <sub>ICM</sub>	-0.3 to +32	V
Output voltage	V <sub>O</sub>	24	V
Power dissipation	AN1358 (AN6562)	350	mW
	AN1358S (AN6562S)	360	
Operating ambient temperature	T <sub>opr</sub>	-20 to +75	°C
Storage temperature	AN1358 (AN6562)	-55 to +150	°C
	AN1358S (AN6562S)	-55 to +125	

### Recommended Operating Range (Ta=25°C)

Parameter	Symbol	Range
Operating supply voltage range	V <sub>CC</sub>	Single power supply 3V to 30V
		Dual power supply ±1.5V to ±15V

### Electrical Characteristics (V<sub>CC</sub>=5V, Ta=25°C)

Parameter	Symbol	Condition	min	typ	max	Unit
Input offset voltage	V <sub>I(offset)</sub>	R <sub>S</sub> =50Ω	—	2	7	mV
Input bias current	I <sub>bias</sub>		—	—	250	nA
Input offset current	I <sub>IO</sub>		—	—	50	nA
Common-mode input voltage width	V <sub>CM</sub>		0	—	V <sub>CC</sub> -1.5	V
Supply current	I <sub>CC</sub>	R <sub>L</sub> =∞	—	0.6	1.2	mA
Voltage gain	G <sub>V</sub>	R <sub>L</sub> ≥2kΩ	—	100	—	dB
Maximum output voltage	V <sub>O(max.)</sub>	R <sub>L</sub> ≥2kΩ	V <sub>CC</sub> -1.5	—	—	V
Common-mode rejection ratio	CMR		65	85	—	dB
Supply voltage rejection ratio	SVR		65	100	—	dB
Channel separation	CS	f=1 to 20kHz	—	120	—	dB
Output source current	I <sub>O(source)</sub>	V <sub>in</sub> <sup>+</sup> =1V, V <sub>in</sub> <sup>-</sup> =0V	20	40	—	mA
Output sink current	I <sub>SINK</sub>	V <sub>in</sub> <sup>+</sup> =0V, V <sub>in</sub> <sup>-</sup> =1V	10	20	—	mA

Operational  
Amplifiers

### Application Circuit

Non-inverting Amplifier

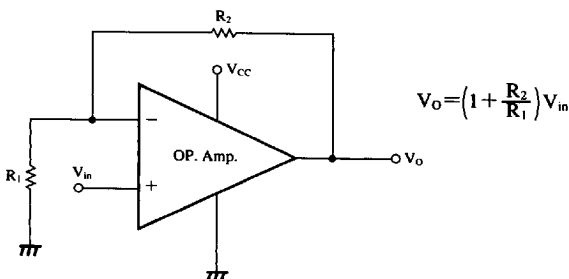

### Pin Descriptions

Pin No.	Pin name
1	Ch.1 output pin
2	Ch.1 inverting input pin
3	Ch.1 non-inverting input pin
4	Negative supply voltage (GND)
5	Ch.2 non-inverting input pin
6	Ch.2 inverting input pin
7	Ch.2 output pin
8	Positive supply voltage

6932852 0012381 550

Panasonic

■ Characteristics Curve

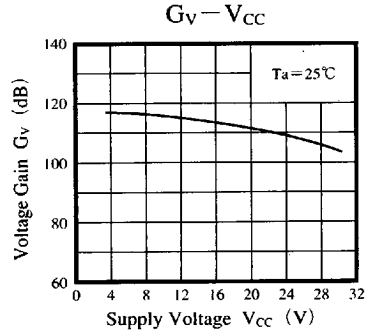
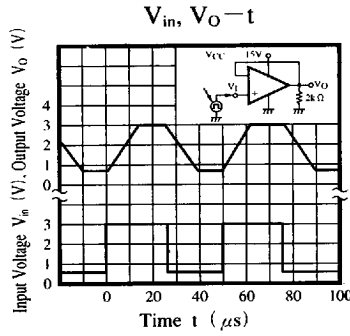
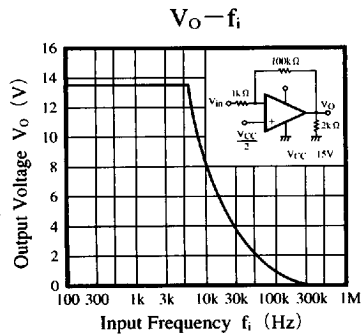
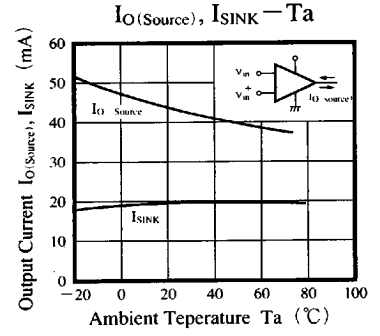
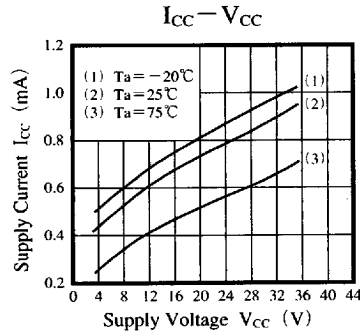
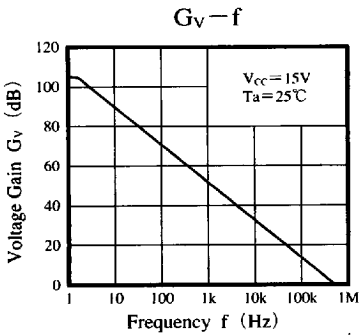
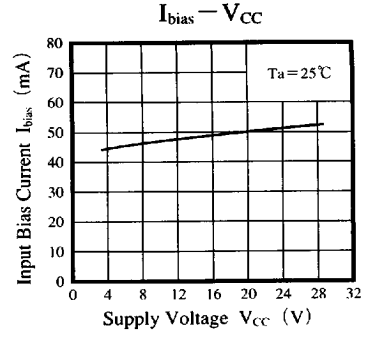
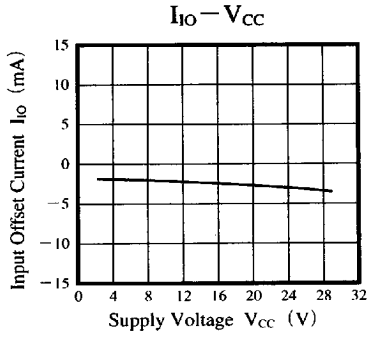
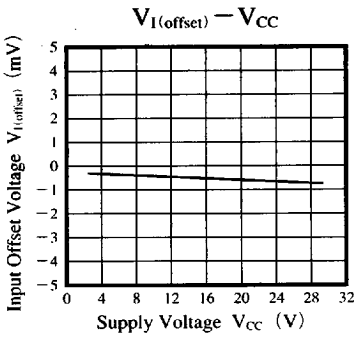

■ 6932852 0012382 497 ■

Panasonic