

# 10MHz, 6V/ $\mu$ s, Dual Rail-to-Rail Input and Output Precision C-Load Op Amp

## DESCRIPTION

The RH1498 is a dual, rail-to-rail input and output precision C-Load™ op amp with a 10MHz gain-bandwidth product and a 6V/ $\mu$ s slew rate.

The RH1498 is designed to maximize input dynamic range by delivering precision performance over the full supply voltage. Using a patented technique, the input stages of the RH1498 are trimmed, one at the negative supply and the other at the positive supply. The resulting guaranteed common mode rejection is much better than other rail-to-rail input op amps. When used as a unity-gain buffer in front of single supply 12-bit A-to-D converters, the RH1498 is guaranteed to add less than 1LSB of error even in single 3V supply systems.

With 110dB of supply rejection, the RH1498 maintains its performance over a supply range of 2.2V to 36V. The inputs can be driven beyond the supplies without damage or phase reversal of the output. These op amps remain stable while driving capacitive loads up to 10,000pF.

The wafer lots are processed to Linear Technology's in-house Class S flow to yield circuits usable in stringent military and space applications.

LT, LTC and LT are registered trademarks of Linear Technology Corporation.  
C-Load is a trademark of Linear Technology Corporation.

## ABSOLUTE MAXIMUM RATINGS

### (Note 1)

Total Supply Voltage ( $V^+$ to $V^-$ ) .....	36V
Input Current .....	$\pm 10\text{mA}$
Output Short-Circuit Duration (Note 2) .....	Continuous
Operating Temperature Range .....	$-55^\circ\text{C}$ to $125^\circ\text{C}$
Specified Temperature Range .....	$-55^\circ\text{C}$ to $125^\circ\text{C}$
Junction Temperature .....	$150^\circ\text{C}$
Storage Temperature Range .....	$-65^\circ\text{C}$ to $150^\circ\text{C}$
Lead Temperature (Soldering, 10 sec) .....	$300^\circ\text{C}$

## BURN-IN CIRCUIT

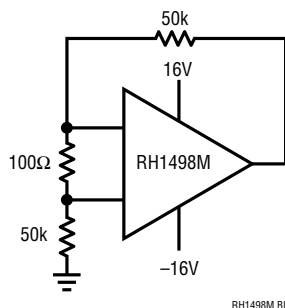

## PACKAGE INFORMATION

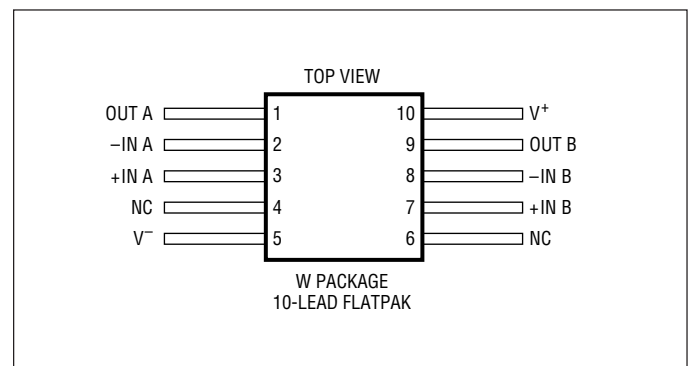

**TABLE 1: ELECTRICAL CHARACTERISTICS**(Pre-Irradiation)  $V_S = \pm 15V$ ,  $V_{CM} = V_{OUT} = 0V$ , unless otherwise noted.

SYMBOL	PARAMETER	CONDITIONS	NOTES	$T_A = 25^\circ C$			SUB-GROUP	$-55^\circ C \leq T_A \leq 125^\circ C$			SUB-GROUP	UNITS
				MIN	TYP	MAX		MIN	TYP	MAX		
$V_{OS}$	Input Offset Voltage	$V_{CM} = V^+, V^-$ $V_{CM} = 14.5V, -14.5V$			200	800	1		350	1100	2, 3	$\mu V$ $\mu V$
	Input Offset Voltage Match (Channel-to-Channel) (Note 3)	$V_{CM} = V^+ \text{ to } V^-$ $V_{CM} = 14.5V \text{ to } -14.5V$	3		250	1400			450	1800		$\mu V$ $\mu V$
$I_B$	Input Bias Current	$V_{CM} = V^+$ $V_{CM} = 14.5V$ $V_{CM} = V^-$ $V_{CM} = -14.5V$		0	250	715	1		500	1200	2, 3	nA nA nA nA
	Input Bias Current Match (Channel-to-Channel) (Note 3)	$V_{CM} = V^+, V^-$ $V_{CM} = 14.5V, -14.5V$	3	0	12	120			50	400		nA nA
$I_{OS}$	Input Offset Current	$V_{CM} = V^+, V^-$ $V_{CM} = 14.5V, -14.5V$			6	70	1		40	300	2, 3	nA nA
	Input Voltage Range			-15		15		-14.5		14.5		V
	Input Noise Voltage	0.1Hz to 10Hz			400							nV <sub>p-p</sub>
$e_n$	Input Noise Voltage Density	$f = 1kHz$			12							nV/ $\sqrt{Hz}$
$i_n$	Input Noise Current Density	$f = 1kHz$			0.3							pA/ $\sqrt{Hz}$
$A_{VOL}$	Large-Signal Voltage Gain	$V_O = -14.5V \text{ to } 14.5V$ , $R_1 = 10k$		1000	5200		4	60	400		5, 6	V/mV
		$V_O = -10V \text{ to } 10V$ , $R_1 = 2k$		500	2300			25	100			V/mV
CMRR	Common Mode Rejection Ratio	$V_{CM} = V^+ \text{ to } V^-$ $V_{CM} = 14.5V \text{ to } -14.5V$		90	102		1	86	102		2, 3	dB dB
	CMRR Match (Channel-to-Channel) (Note 3)	$V_{CM} = V^+ \text{ to } V^-$ $V_{CM} = 14.5V \text{ to } -14.5V$	3	84	103			80	100			dB dB
PSRR	Power Supply Rejection Ratio	$V_S = \pm 2V \text{ to } \pm 16V$		90	110		1	88			2, 3	dB
	PSRR Match (Channel-to-Channel) (Note 3)	$V_S = \pm 2V \text{ to } \pm 16V$	3	83	110			82	100			dB
$V_{OL}$	Output Voltage Swing (Low) (Note 4)	No Load			18	30			25	75		mV
		$I_{SINK} = 1mA$	4		50	100	4		70	150	5, 6	mV
		$I_{SINK} = 10mA$			230	500						mV
		$I_{SINK} = 5mA$							180	500		mV
$V_{OH}$	Output Voltage Swing (High) (Note 4)	No Load			2.5	10			5	25		mV
		$I_{SINK} = 1mA$	4		75	150	4		100	250	5, 6	mV
		$I_{SINK} = 10mA$			420	800						mV
		$I_{SINK} = 5mA$							300	800		mV
$I_{SC}$	Short-Circuit Current			$\pm 15$	$\pm 30$		1	$\pm 7.5$	$\pm 12$	2, 3	mA	
$I_S$	Supply Current per Amp			1.8	2.5		1	2.2	3	2, 3	mA	
GBW	Gain-Bandwidth Product	$f = 100kHz$		6.8	10.5			5.8	8.5			MHz
SR	Slew Rate	$A_V = -1$ , $R_L = 2k$ , $V_O = \pm 10V$ , Measure at $V_O = \pm 5V$		3.5	6		4	2.2	4	5, 6		V/ $\mu s$

**TABLE 1A: ELECTRICAL CHARACTERISTICS**(Post-Irradiation)  $V_S = \pm 15V$ ,  $V_{CM} = 0V$ ,  $T_A = 25^\circ C$ , unless otherwise noted

SYMBOL	PARAMETER	CONDITIONS	NOTES	10Krad(Si)		20Krad(Si)		50Krad(Si)		100Krad(Si)		200Krad(Si)		UNITS
				MIN	MAX	MIN	MAX	MIN	MAX	MIN	MAX	MIN	MAX	
$V_{OS}$	Input Offset Voltage	$V_{CM} = V^+, V^-$		950		950		950		950		950		$\mu V$
$I_B$	Input Bias Current	$V_{CM} = V^+, V^-$		765		815		865		915		965		nA
$I_{OS}$	Input Offset Current	$V_{CM} = V^+, V^-$		100		100		100		100		100		nA
	Input Voltage Range			$V^-$	$V^+$	$V^-$	$V^+$	$V^-$	$V^+$	$V^-$	$V^+$	$V^-$	$V^+$	V
$A_{VOL}$	Large-Signal Voltage Gain	$V_O = -14.5V$ to $14.5V$ , $R_1 = 10k$		500		500		500		500		500		V/mV
		$V_O = -10V$ to $10V$ , $R_1 = 2k$		250		250		250		250		250		V/mV
CMRR	Common Mode Rejection Ratio	$V_{CM} = V^+$ to $V^-$		86		86		86		86		86		dB
	CMRR Match (Channel-to-Channel)	$V_{CM} = V^+$ to $V^-$	3	83		83		83		83		83		dB
PSRR	Power Supply Rejection Ratio	$V_S = \pm 2V$ to $\pm 16V$		90		90		90		90		90		dB
	PSRR Match (Channel-to-Channel)	$V_S = \pm 2V$ to $\pm 16V$	3	83		83		83		83		83		dB
$V_{OUT}$	Output Voltage Swing Low	No Load		60		60		60		60		60		mV
		$I_{SINK} = 1mA$	4	100		100		100		100		100		mV
		$I_{SINK} = 10mA$		500		500		500		500		500		mV
	Output Voltage Swing High	No Load		20		20		20		20		20		mV
$I_{SINK} = 1mA$		4	150		150		150		150		150		mV	
$I_{SINK} = 10mA$			800		800		800		800		800		mV	
$I_{SC}$	Short-Circuit Current		$\pm 10$		$\pm 10$		$\pm 10$		$\pm 10$		$\pm 10$		mA	
$I_S$	Supply Current		2.5		2.5		2.5		2.5		2.5		mA	
GBW	Gain-Bandwidth Product	$f = 100kHz$		4.5		4.5		4.5		4.5		4.5		MHz
SR	Slew Rate	$A_V = -1$ , $R_L = 10k$ , $V_O = \pm 10V$ , Measure at $V_O = \pm 5V$		3		3		3		3		3		V/ $\mu s$

**TABLE 2: ELECTRICAL CHARACTERISTICS**(Pre-Irradiation)  $V_S = 3V, 5V$ ;  $V_{CM} = V_{OUT} = \text{half supply}$ , unless otherwise noted.

SYMBOL	PARAMETER	CONDITIONS	NOTES	$T_A = 25^\circ\text{C}$			SUB-GROUP	$-55^\circ\text{C} \leq T_A \leq 125^\circ\text{C}$			SUB-GROUP	UNITS
				MIN	TYP	MAX		MIN	TYP	MAX		
$V_{OS}$	Input Offset Voltage	$V_{CM} = V^+, V^-$ $V_{CM} = V^+ - 0.5V, V^- + 0.5V$			150	800	1		300	1100	2, 3	$\mu\text{V}$ $\mu\text{V}$
	Input Offset Voltage Match (Channel-to-Channel) (Note 3)	$V_{CM} = V^+ \text{ to } V^-$ $V_{CM} = V^+ - 0.5V, V^- + 0.5V$	3		200	1400			350	1800		$\mu\text{V}$ $\mu\text{V}$
$I_B$	Input Bias Current	$V_{CM} = V^+$ $V_{CM} = V^+ - 0.5V$ $V_{CM} = V^-$ $V_{CM} = V^- + 0.5V$		0	250	650	1	0	450	1100	2, 3	nA nA nA nA
	Input Bias Current Match (Channel-to-Channel) (Note 3)	$V_{CM} = V^+, V^-$ $V_{CM} = V^+ - 0.5V, V^- + 0.5V$	3	0	10	100		0	30	400		nA nA
$I_{OS}$	Input Offset Current	$V_{CM} = V^+, V^-$ $V_{CM} = V^+ - 0.5V, V^- + 0.5V$			5	65	1		15	300	2, 3	nA nA
	Input Voltage Range			$V^-$		$V^+$		$V^- + 0.5V$		$V^+ - 0.5V$		V
	Input Noise Voltage	0.1Hz to 10Hz			400							nV <sub>p-p</sub>
$e_n$	Input Noise Voltage Density	$f = 1\text{kHz}$			12							nV/ $\sqrt{\text{Hz}}$
$i_n$	Input Noise Current Density	$f = 1\text{kHz}$			0.3							pA/ $\sqrt{\text{Hz}}$
$C_{IN}$	Input Capacitance				5							pF
$A_{VOL}$	Large-Signal Voltage Gain	$V_S = 5V, V_O = 75\text{mV to } 4.8V,$ $R_L = 10k$		600	3800		4	60	210		5, 6	V/mV
		$V_S = 3V, V_O = 75\text{mV to } 2.8V,$ $R_L = 10k$		500	2000			25	210			V/mV
CMRR	Common Mode Rejection Ratio	$V_S = 5V, V_{CM} = V^+ \text{ to } V^-$ $V_S = 3V, V_{CM} = V^+ \text{ to } V^-$		76	90		1				2, 3	dB dB
		$V_S = 5V, V_{CM} = 0.5V \text{ to } 4.5V$ $V_S = 3V, V_{CM} = 0.5V \text{ to } 2.5V$		72	86			68	85			dB dB
	CMRR Match (Channel-to-Channel) (Note 3)	$V_S = 5V, V_{CM} = V^+ \text{ to } V^-$ $V_S = 3V, V_{CM} = V^+ \text{ to } V^-$	3	75	91		1				2, 3	dB dB
		$V_S = 5V, V_{CM} = 0.5V \text{ to } 4.5V$ $V_S = 3V, V_{CM} = 0.5V \text{ to } 2.5V$		70	86			66	82			dB dB
PSRR	Power Supply Rejection Ratio	$V_S = 2.2V \text{ to } 12V,$ $V_{CM} = V_O = 0.5V$		88	105		1	86	104		2, 3	dB
		$V_S = 2.2V \text{ to } 12V,$ $V_{CM} = V_O = 0.5V$	3	82	120			80	118			dB
$V_{OL}$	Output Voltage Swing (Low) (Note 4)	No Load			14	30			25	75		mV
		$I_{SINK} = 1\text{mA}$	4		50	100	4		65	150	5, 6	mV
		$I_{SINK} = 2.5\text{mA}$			90	200			110	220		mV
$V_{OH}$	Output Voltage Swing (High) (Note 4)	No Load		2.5	10			5	25			mV
		$I_{SINK} = 1\text{mA}$	4		70	150	4		100	250	5, 6	mV
		$I_{SINK} = 2.5\text{mA}$			140	250			180	300		mV
$I_{SC}$	Short-Circuit Current	$V_S = 5V$		$\pm 12.5$	24		1	$\pm 5$	$\pm 10$		2, 3	mA
		$V_S = 3V$		$\pm 12.0$	19			$\pm 5$	$\pm 9.5$			mA
$I_S$	Supply Current per Amp			1.7	2.2		1	2	2.7		2, 3	mA

**TABLE 2: ELECTRICAL CHARACTERISTICS**(Pre-Irradiation)  $V_S = 3V, 5V$ ;  $V_{CM} = V_{OUT} = \text{half supply}$ , unless otherwise noted.

SYMBOL	PARAMETER	CONDITIONS	NOTES	$T_A = 25^\circ\text{C}$			SUB-GROUP	$-55^\circ\text{C} \leq T_A \leq 125^\circ\text{C}$			SUB-GROUP	UNITS
				MIN	TYP	MAX		MIN	TYP	MAX		
GBW	Gain-Bandwidth Product	$V_S = 5V, f = 100\text{kHz}$		6.8	10.5			5.8	8.5			MHz
SR	Slew Rate	$V_S = \pm 2.5V, A_V = -1,$ $R_L = 2k, V_O = \pm 2V,$ Measure at $V_O = \pm 1V$		2.6	4.5		4	2	3.6		5, 6	V/ $\mu\text{s}$

**TABLE 2A: ELECTRICAL CHARACTERISTICS**(Post-Irradiation)  $V_S = 5V, 3V$ ;  $V_{CM} = \text{half supply}$ ,  $T_A = 25^\circ\text{C}$ , unless otherwise noted

SYMBOL	PARAMETER	CONDITIONS	NOTES	10Krad(Si)		20Krad(Si)		50Krad(Si)		100Krad(Si)		200Krad(Si)		UNITS
				MIN	MAX	MIN	MAX	MIN	MAX	MIN	MAX	MIN	MAX	
$V_{OS}$	Input Offset Voltage	$V_{CM} = V^+, V^-$		950		950		950		950		950		$\mu\text{V}$
$I_B$	Input Bias Current	$V_{CM} = V^+, V^-$		700		750		809		850		900		nA
$I_{OS}$	Input Offset Current	$V_{CM} = V^+, V^-$		65		65		65		65		65		nA
	Input Voltage Range			$V^-$	$V^+$	$V^-$	$V^+$	$V^-$	$V^+$	$V^-$	$V^+$	$V^-$	$V^+$	V
$A_{VOL}$	Large-Signal Voltage Gain	$V_O = 75\text{mV to } V^+ - 0.2V$ $R_1 = 10k$		300		300		300		300		300		V/mV
CMRR	Common Mode Rejection Ratio	$V_{CM} = V^+ \text{ to } V^-$		70		70		70		70		70		dB
	CMRR Match (Channel-to-Channel)	$V_{CM} = V^+ \text{ to } V^-$	3	70		70		70		70		70		dB
PSRR	Power Supply Rejection Ratio	$V_S = 2.2V \text{ to } 12V,$ $V_{CM} = V_O = 0.5V$		88		88		88		88		88		dB
	PSRR Match (Channel-to-Channel)	$V_S = 2.2V \text{ to } 12V,$ $V_{CM} = V_O = 0.5V$	3	82		82		82		82		82		dB
$V_{OUT}$	Output Voltage Swing Low	No Load		60		60		60		60		60		mV
		$I_{SINK} = 1\text{mA}$	4	100		100		100		100		100		mV
		$I_{SINK} = 2.5\text{mA}$		200		200		200		200		200		mV
	Output Voltage Swing High	No Load		20		20		20		20		20		mV
		$I_{SINK} = 1\text{mA}$	4	150		150		150		150		150		mV
		$I_{SINK} = 2.5\text{mA}$		250		250		250		250		250		mV
$I_{SC}$	Short-Circuit Current			$\pm 8$		$\pm 8$		$\pm 8$		$\pm 8$		$\pm 8$		mA
$I_S$	Supply Current			2.2		2.2		2.2		2.2		2.2		mA
SR	Slew Rate	$V_S = \pm 2.5V, A_V = -1,$ $R_L = 10k, V_O = \pm 2V,$ Measure at $V_O = \pm 1V$		2		2		2		2		2		V/ $\mu\text{s}$

**Note 1:** Absolute Maximum Ratings are those values beyond which the life of a device may be impaired.

**Note 2:** A heat sink may be required to keep the junction temperature below this absolute maximum rating when the output is shorted indefinitely.

**Note 3:** Matching parameters are the difference between amplifiers A and B.

**Note 4:** Output voltage swings are measured between the output and power supply rails.

## TABLE 2: ELECTRICAL TEST REQUIREMENTS

MIL-STD-883 TEST REQUIREMENTS	SUBGROUP
Final Electrical Test Requirements (Method 5004)	1*,2,3,4,5,6
Group A Test Requirements (Method 5005)	1,2,3,4,5,6
Group B and D for Class S, and End Point Electrical Parameters (Method 5005)	1,2,3

\* PDA applies to subgroup 1. See PDA Test Notes.

### PDA Test Notes

The PDA is specified as 5% based on failures from group A, subgroup 1, tests after cooldown as the final electrical test in accordance with method 5004 of MIL-STD-883. The verified failures of group A, subgroup 1, after burn-in divided by the total number of devices submitted for burn-in in that lot shall be used to determine the percent for the lot.

Linear Technology Corporation reserves the right to test to tighter limits than those given.

## TOTAL DOSE BIAS CIRCUIT

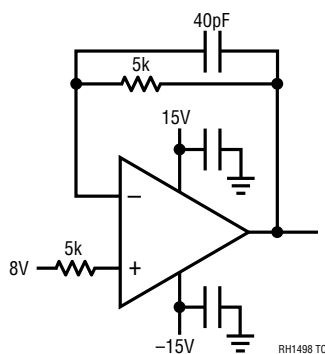

# TYPICAL PERFORMANCE CHARACTERISTICS

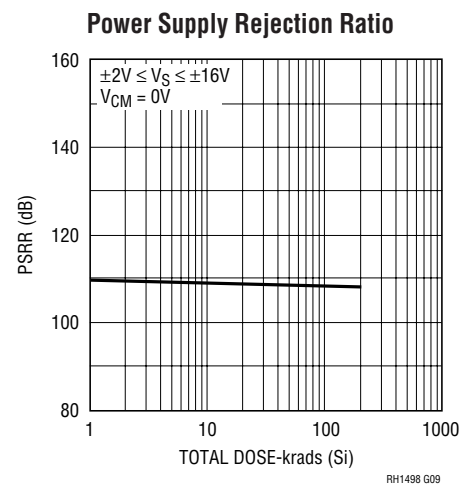
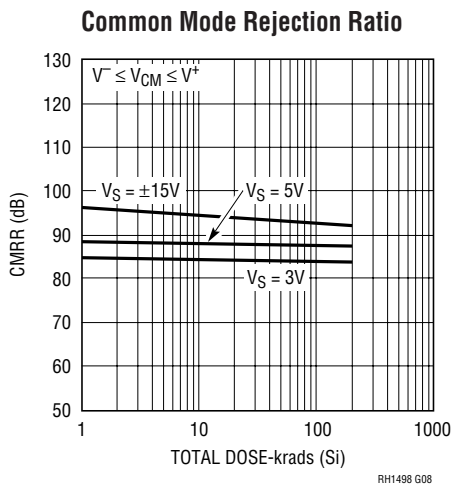
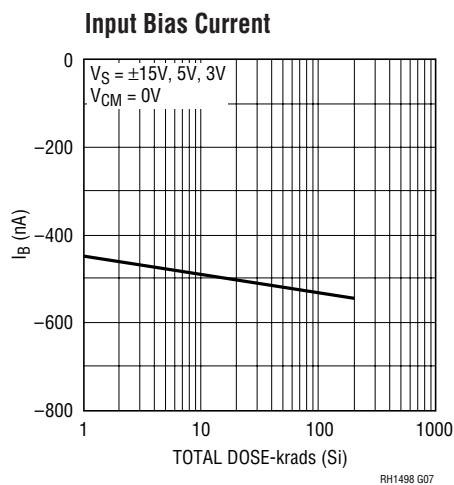
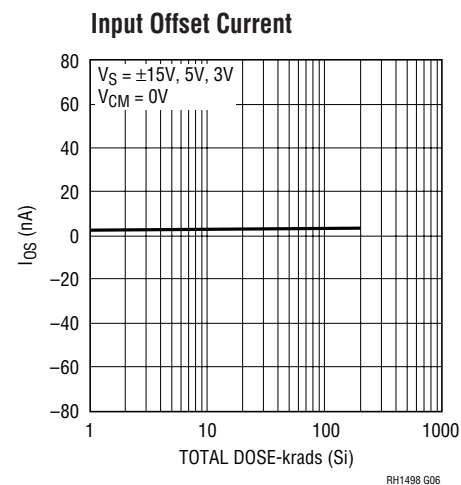
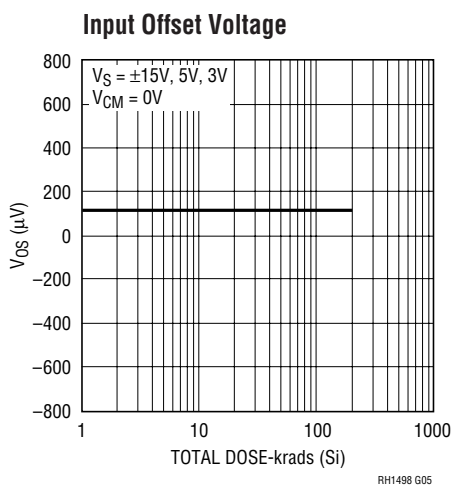
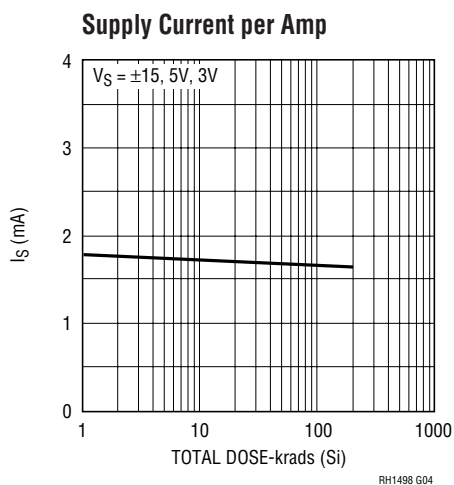
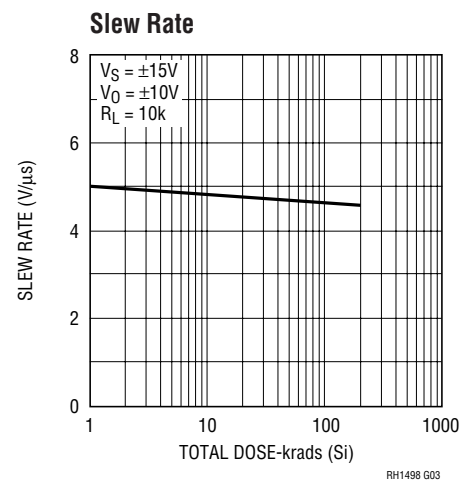
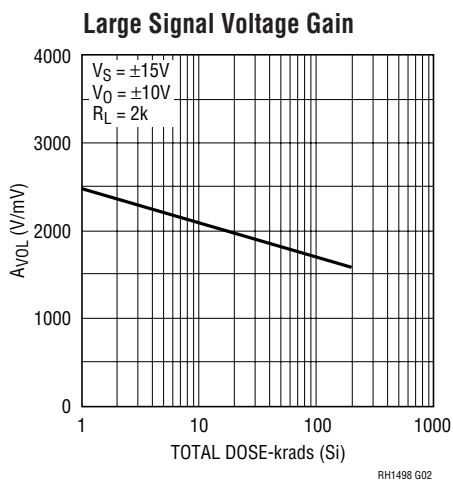
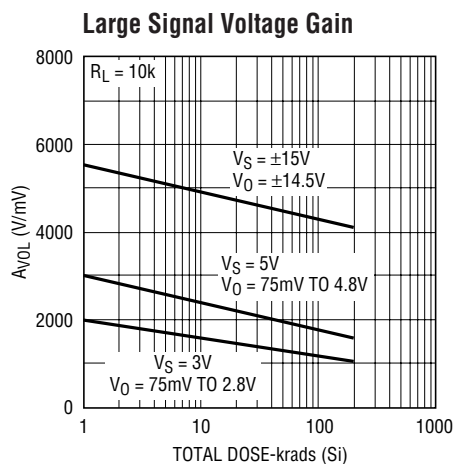

# TYPICAL PERFORMANCE CHARACTERISTICS

Supply Current vs Supply Voltage

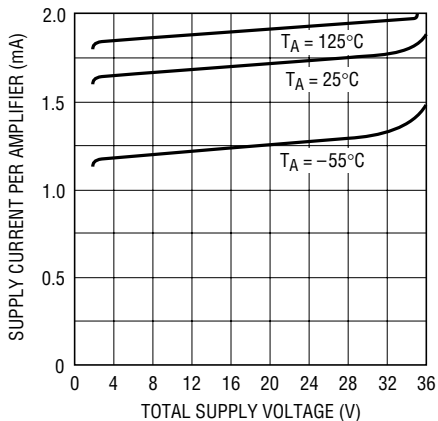

Supply Current vs Temperature

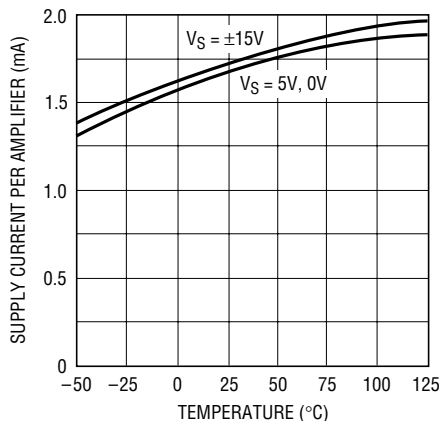

Input Bias Current vs Common Mode Voltage

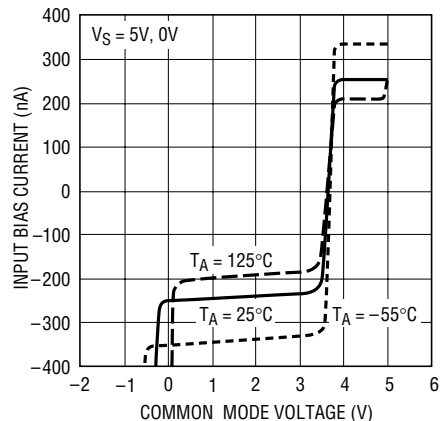

Open-Loop Voltage Gain vs Temperature

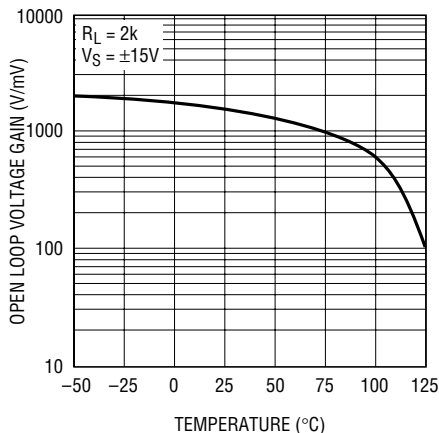

Input Bias Current vs Temperature

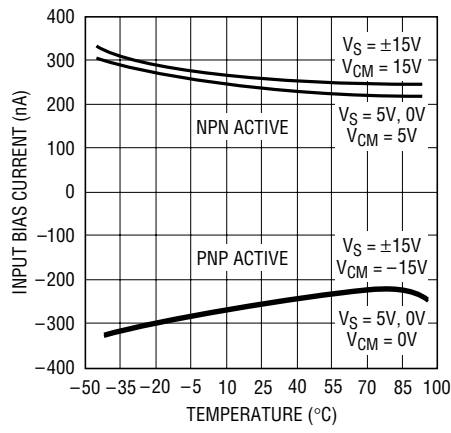

Output Saturation Voltage vs Load Current (Output High)

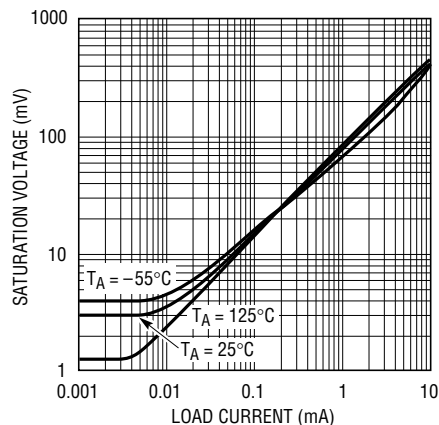

Output Saturation Voltage vs Load Current (Output Low)

