

HA17080 Series

J-FET Input Operational Amplifiers

Description

Since J-FET input operational amplifiers are formed from a pair of J-FET transistors, they provide superlative characteristics, including a high input impedance and a low input bias current. Thus they can be used in a wide range of applications, from general-purpose control equipment to medical applications. In particular, they are optimal for processing signals from high-impedance sensors.

Product Overview

Hitachi J-FET input operational amplifiers are available in single, dual, and quad versions. Other than the HA17080, all products are internal phase compensation types and include a built-in phase compensation capacitor. The HA17080 and the HA17083 allow offset adjustment. These products are also available in "A" grade versions with superlative electrical characteristics to allow the selection of an operational amplifier appropriate for the application.

Item	Product No.			
	HA17080	HA17082	HA17083	HA17084
Number of operational amplifiers (number of channels)	Single	Dual	Dual	Quad
Offset adjustment pin	Yes	No	Yes	No
Phase compensation type	External	Internal	Internal	Internal

Features

- Wide operating power supply voltage range: ± 5 to ± 18 V
- Low input bias current: 30 pA
- Low input offset current: 5 pA
- High input impedance: $10^{12}\Omega$
- High slew rate: 13 V/ μ s
- Wide common mode input voltage range with operation possible near the power-supply voltage (V_{CC}).
- High voltage gain: 106 dB
- The HA17080 and HA17083 support offset adjustment.
- Pin compatible with the Texas Instruments TL080 series.

Caution

1. Since these products are high input impedance operational amplifiers, contamination may cause the input bias and input offset currents to increase if they are handled with bare hands.
Avoid contamination when handling these devices.
2. Since these products provide a high slew rate, oscillation may occur due to load capacitances.
($C_L < 100$ pF: voltage follower mode)

Pin Arrangements

HA17080

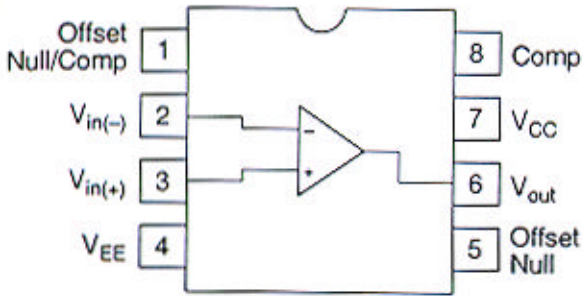

(Top view)

HA17082

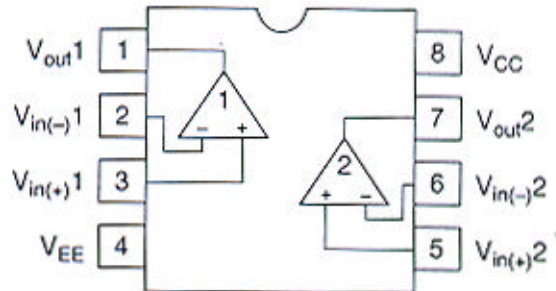

(Top view)

HA17083

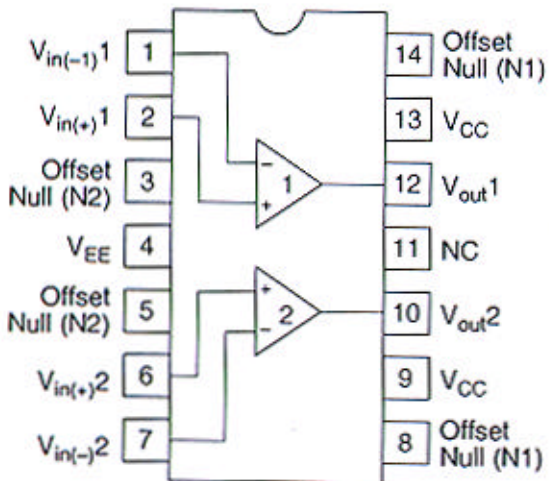

(Top view)

HA17084

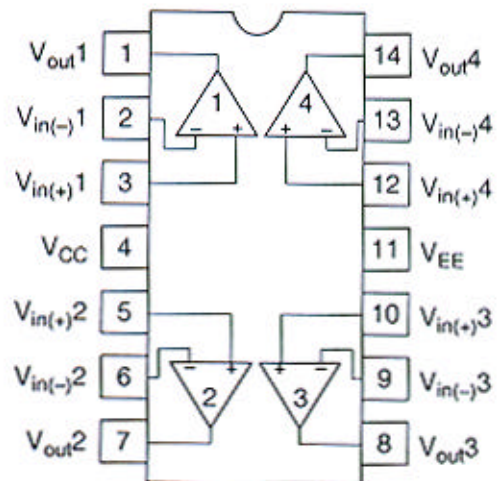

(Top view)

HA17080 Series

Absolute Maximum Ratings ($T_a = 25^\circ\text{C}$)

Item	Symbol	P, PS Series	Unit	Notes
Power-supply voltage	V_{CC}	+18	V	
	V_{EE}	-18	V	
Differential input voltage	$V_{in(diff)}$	± 30	V	
Input voltage	V_{in}	± 15	V	1
Allowable power dissipation	P_T	625	mW	2
Operating temperature	T_{opr}	-20 to +75	$^\circ\text{C}$	
Storage temperature	T_{stg}	-55 to +125	$^\circ\text{C}$	

- Notes: 1. When the power-supply voltage is less than ± 15 V, the input voltage must fall within the power-supply voltage range.
2. These are the allowable values up to $T_a = 50^\circ\text{C}$ for the P and PS series. Derate by $8.3 \text{ mW}/^\circ\text{C}$ above that temperature.

HA17080 Series

Electrical Characteristics ($V_{CC} = -V_{EE} = 15\text{ V}$, $T_a = 25^\circ\text{C}$)

Item	Symbol	HA17080 Series			HA17080A Series			Unit	Test Condition	Notes
		Min	Typ	Max	Min	Typ	Max			
Input offset voltage	V_{IO}	—	5	15	—	3	6	mV	$R_S = 50\ \Omega$	1
Input offset current	I_{IO}	—	5	200	—	5	100	pA	$I_{IO} = I_{IB(+)} - I_{IB(-)} $	1
Input bias current	I_{IB}	—	30	400	—	30	200	pA		1, 2
Common-mode input voltage range	V_{CM}	± 10	—	—	± 11	—	—	V		1
Maximum output voltage amplitude	V_{op-p}	24	27	—	24	27	—	V	$R_L \geq 10\ \text{k}\Omega$	
		20	24	—	20	24	—		$R_L \geq 2\ \text{k}\Omega$	
Voltage Gain	A_{VD}	88	106	—	94	106	—	dB	$R_L \geq 2\ \text{k}\Omega$, $V_O = 10\ \text{V}$	1
Common-mode rejection ratio	CMRR	70	86	—	80	86	—	dB	$R_S \leq 10\ \text{k}\Omega$	1
Power-supply rejection ratio	PSRR	70	86	—	80	86	—	dB	$R_S \leq 10\ \text{k}\Omega$	1
Current drain	I_{CC}	—	1.4	2.8	—	1.4	2.8	mA		3
Bandwidth	BW	—	3	—	—	3	—	MHz	$A_{VD} = 1$	
Slew rate	SR	—	13	—	—	13	—	V/ μs	$V_{in} = 10\ \text{V}$, $R_L = 2\ \text{k}\Omega$, $C_L = 100\ \text{pF}$, $A_{VD} = 1$	
Channel separation	CS	—	120	—	—	120	—	dB	$A_{VD} = 100$	
Rise time	t_r	—	0.1	—	—	0.1	—	μs	$V_{in} = 20\ \text{mV}$, $R_L = 2\ \text{k}\Omega$	
Overshoot	V_{over}	—	10	—	—	10	—	%	$C_L = 100\ \text{pF}$, $A_{VD} = 1$	
Input resistance	R_{in}	—	10^{12}	—	—	10^{12}	—	Ω		
Input noise voltage	V_n	—	35	—	—	35	—	nV/ $\sqrt{\text{Hz}}$	$R_S = 100\ \Omega$, $f = 1\ \text{kHz}$	

- Notes: 1. The non-A ratings apply to the HA17080, HA17082, HA17083, and HA17084. The A version ratings apply to the HA17080A, HA17082A, HA17083A, and HA17084A.
2. This is the J-FET gate leakage current, which is temperature dependent. The junction temperature must be held near room temperature when measuring this parameter.
3. This is the per-channel value.

HA17080 Series

Voltage Offset Test Circuit

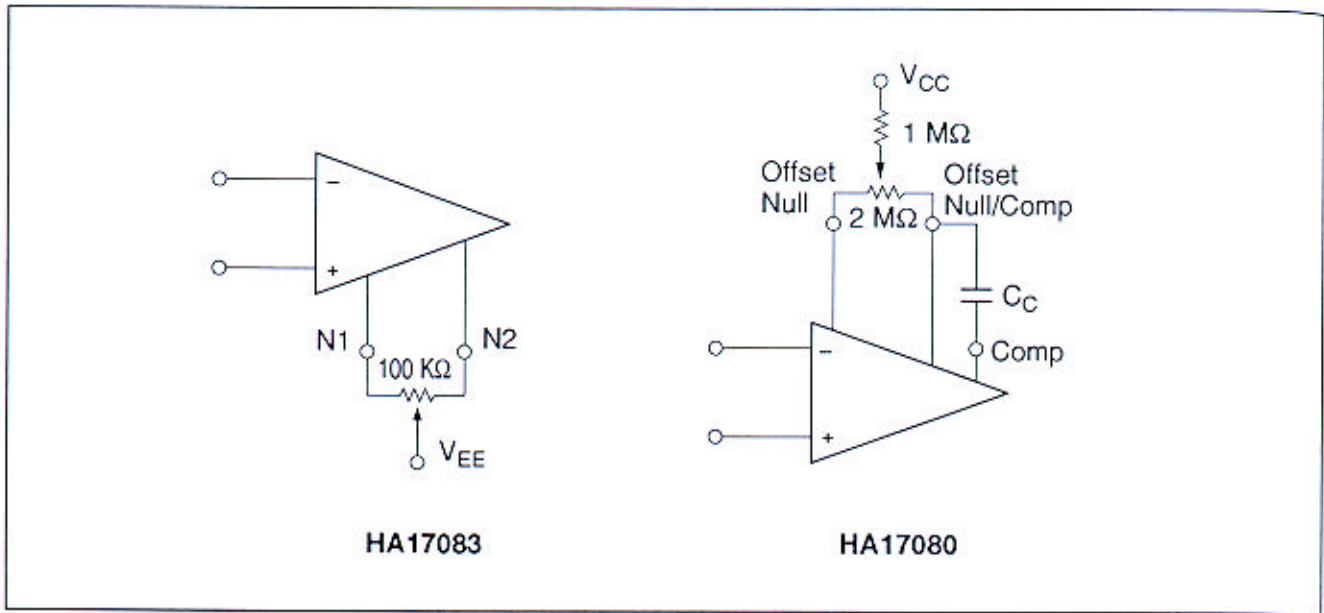

Circuit Structure

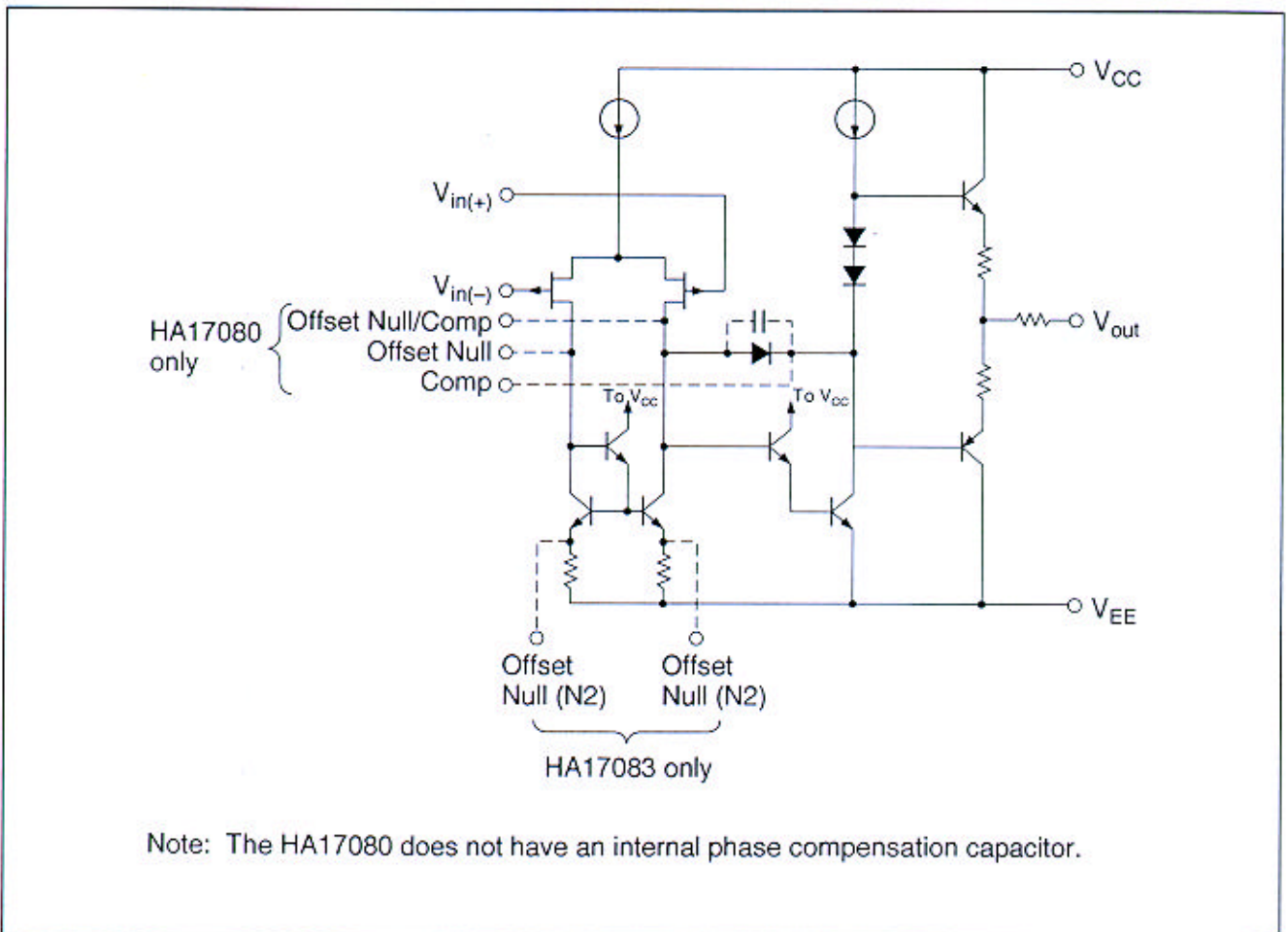

Input Bias Current vs. Ambient Temperature Characteristics

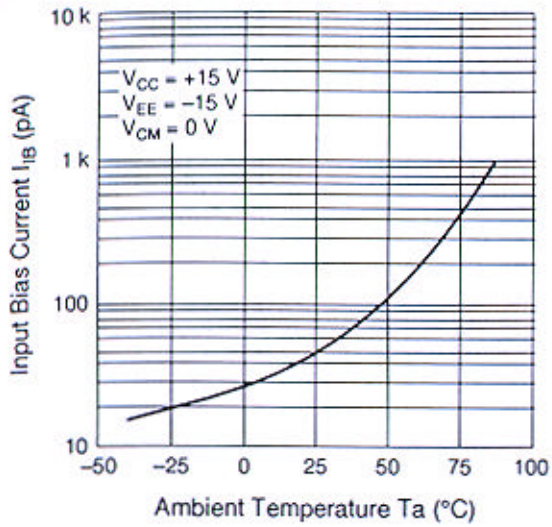

Input Bias Current vs. Common-Mode Input Voltage Characteristics

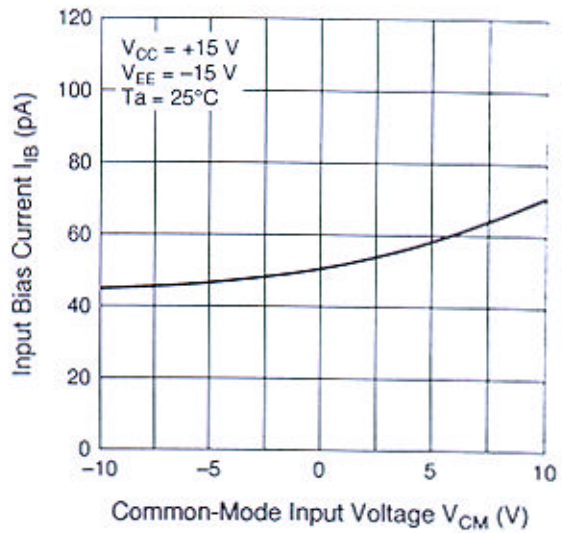

Maximum Output Voltage Amplitude vs. Frequency Characteristics

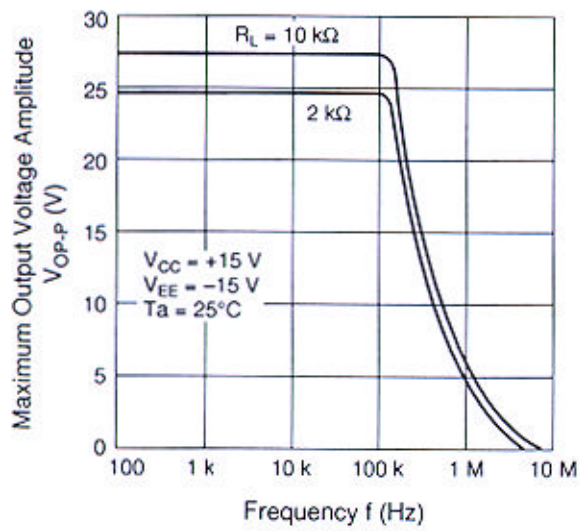

Maximum Output Voltage Amplitude vs. Ambient Temperature Characteristics

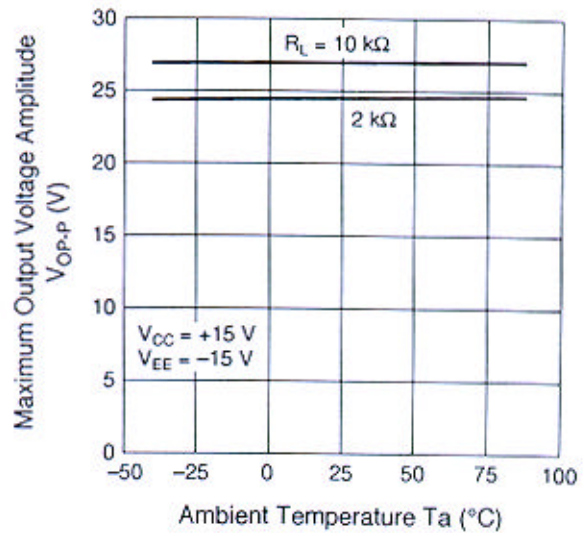

Maximum Output Voltage Amplitude vs. Load Resistance Characteristics

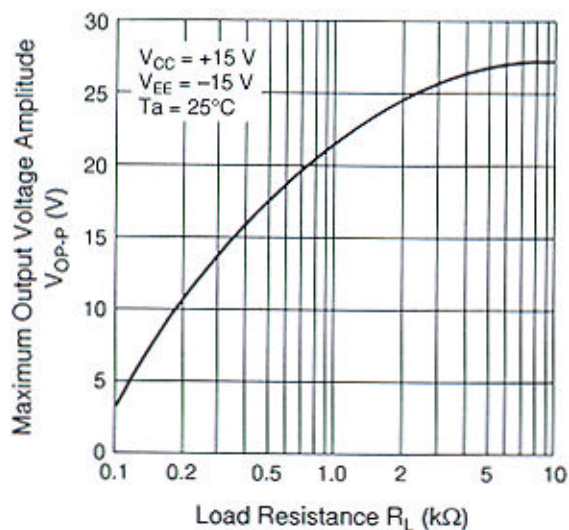

Maximum Output Voltage Amplitude vs. Power-Supply Voltage Characteristics

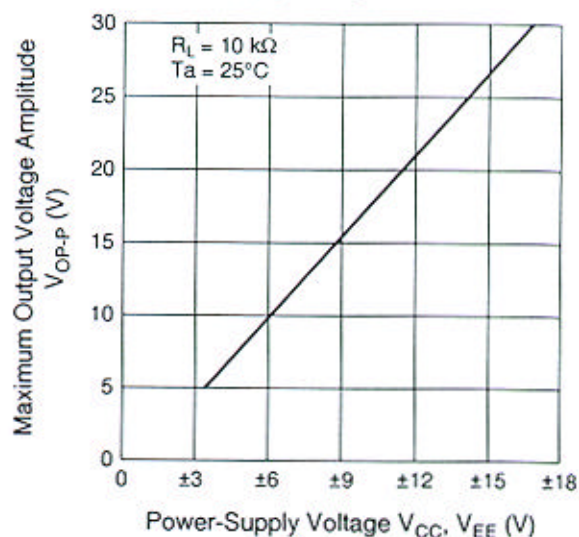

Voltage Gain vs. Frequency Characteristics (1)

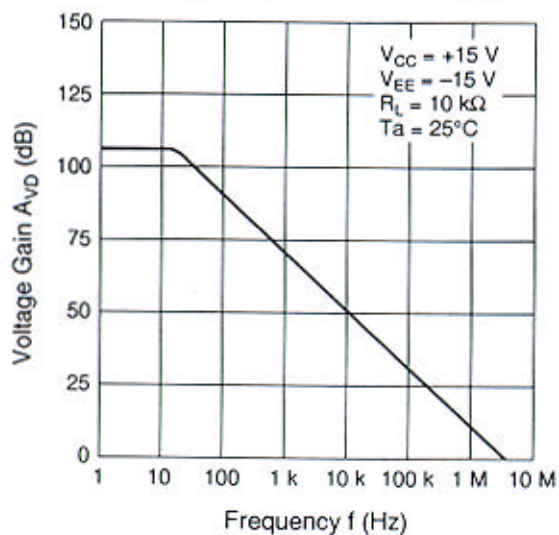

Voltage Gain vs. Frequency Characteristics (2)

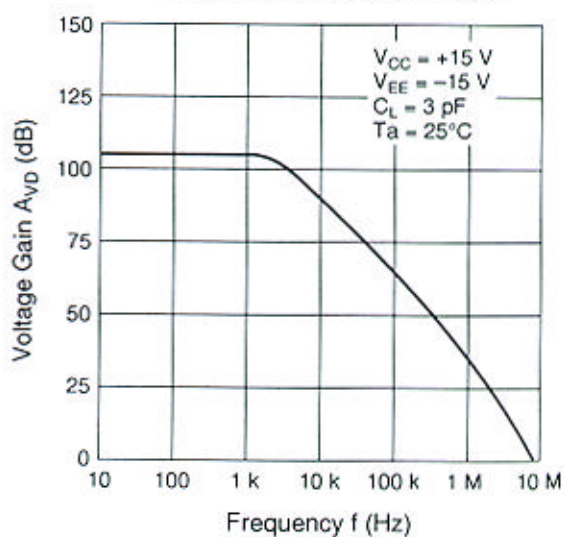

Voltage Gain vs. Ambient Temperature Characteristics

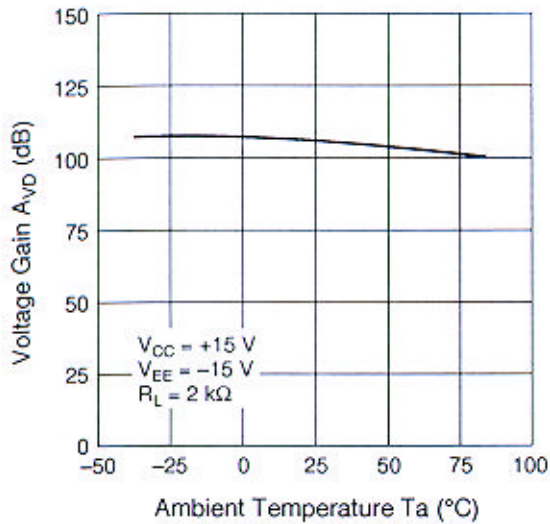

Input Noise Voltage vs. Frequency Characteristics

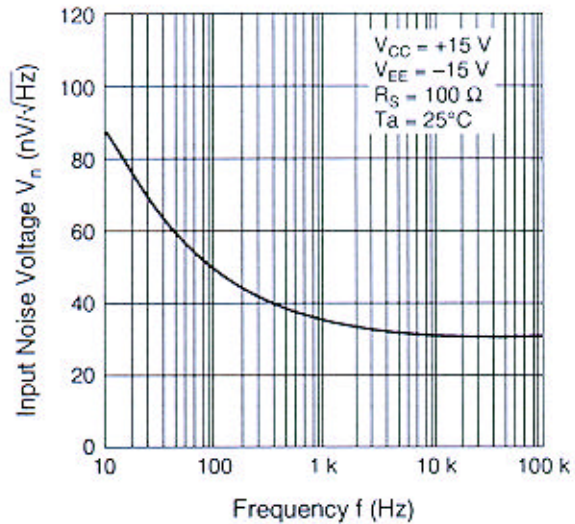

Common-Mode Rejection Ratio vs. Frequency Characteristics

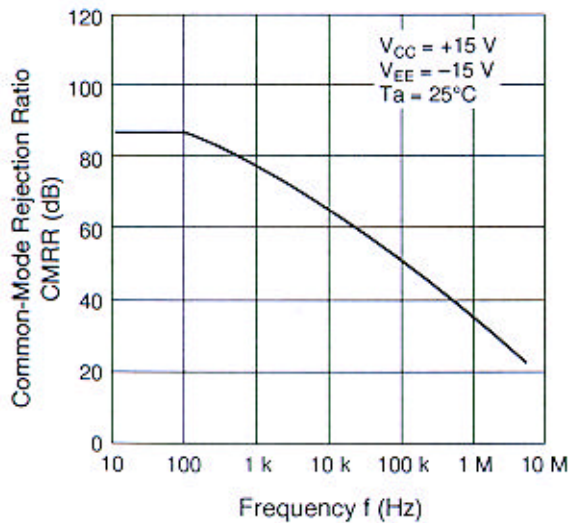

Power-Supply Rejection Ratio vs. Frequency Characteristics

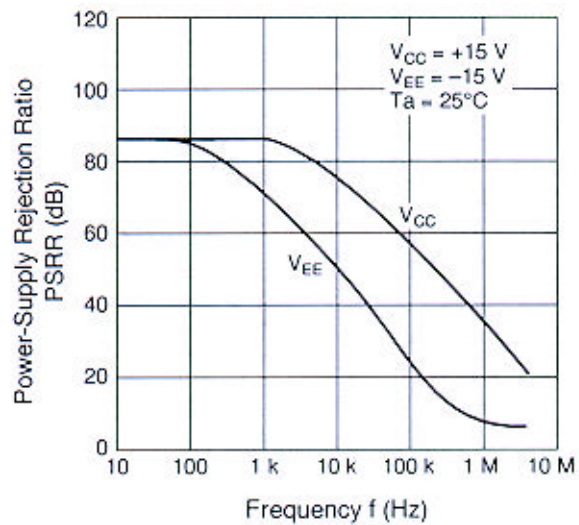

HA17080 Series

Current Drain vs. Power-Supply Voltage Characteristics

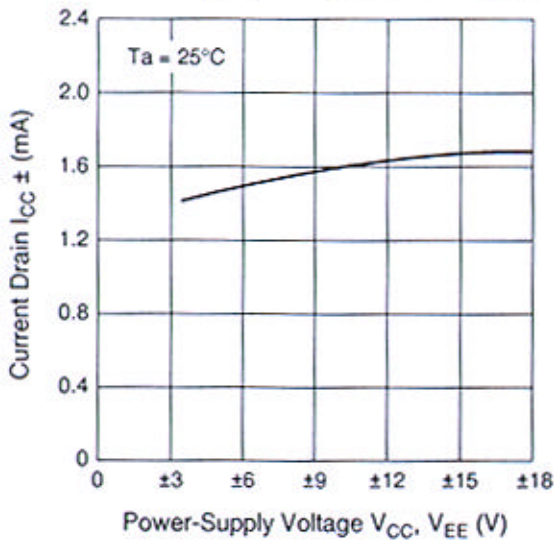

Current Drain vs. Ambient Temperature Characteristics

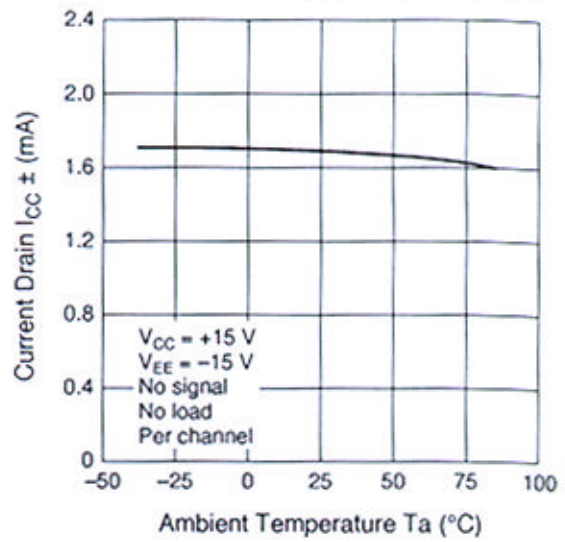

Power Dissipation vs. Power-Supply Voltage Characteristics

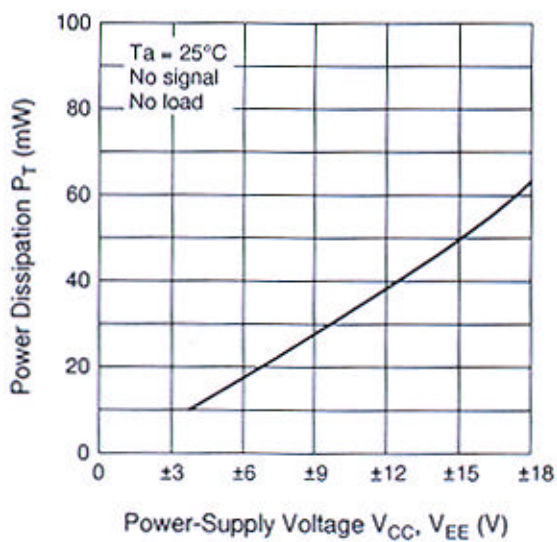

Power Dissipation vs. Ambient Temperature

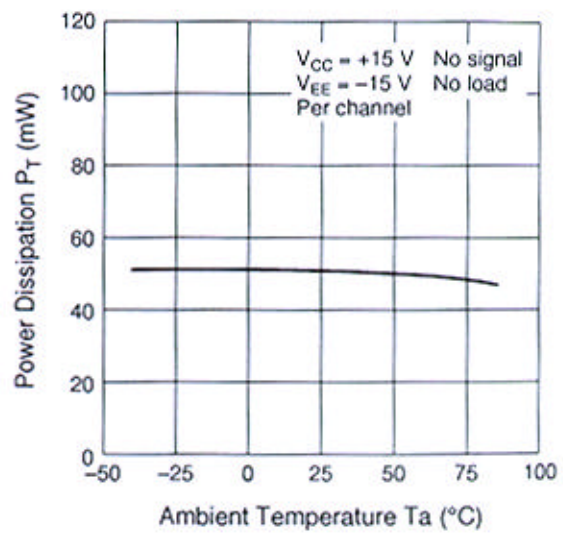

Voltage Follower Large Signal Pulse Response Characteristics

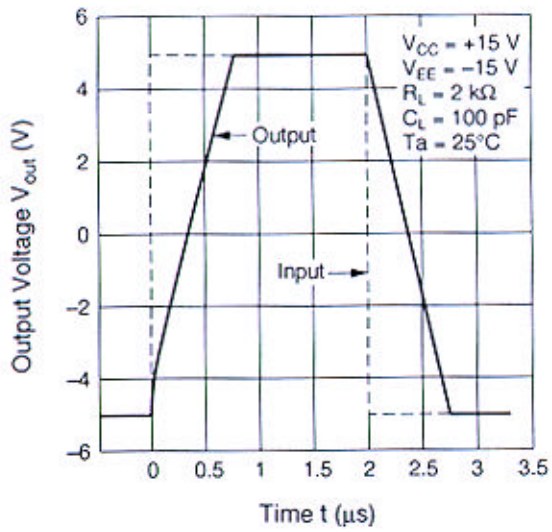

HA17083 Offset Adjustment Characteristics

