

InAlGaAs-Laser Diode 1000 mW with FC-connector 750 mW ²⁾

SFH 487401
SFH 487406

Features

- Monochromatic, coherent radiation source for pulse and cw-operation
- MOCVD quantum-well structure, strained layer technology
- Small size package for efficient thermal coupling
- Emission width: 200 μm
- SFH 487401: Microoptics for improved farfield pattern
- SFH 487406: Microoptics for efficient fiber coupling

Applications

- Pumping of Nd-YAG-Lasers
- Medical applications
- Laser soldering
- Energy transmission
- Testing and measurement applications

Type	Ordering code
SFH 487401	Q62702-P367
SFH 487406	Q62702-P368

Maximum Ratings

Parameter	Symbol	Values	Unit
Laser Diode ($T_{\text{sub}} = 25\text{ }^{\circ}\text{C}$)			
cw-output power			
SFH 487401	Φ_{eCW}	1100 ¹⁾	mW
SFH 487406	Φ_{eCW}	800 ²⁾	mW
Pulse-output power			
$\tau < 150\text{ }\mu\text{s}$, duty cycle $\leq 1\text{ }%$			
SFH 487401	Φ_{ePuls}	1500 ¹⁾	mW
SFH 487406	Φ_{ePuls}	1100 ²⁾	mW
Reverse voltage	V_{R}	3	V
Operating temperature	T_{sub}	- 10 ... + 60	$^{\circ}\text{C}$
Junction temperature	T_{j}	max. 65	$^{\circ}\text{C}$

¹⁾ in NA=0.6

²⁾ measured with a fiber NA=0.35, core diameter=125 μm , length=5 m, with attenuation=8 dB/km 10.94

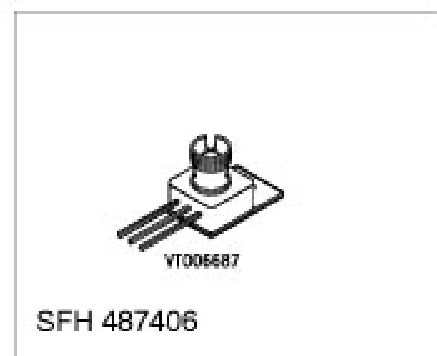
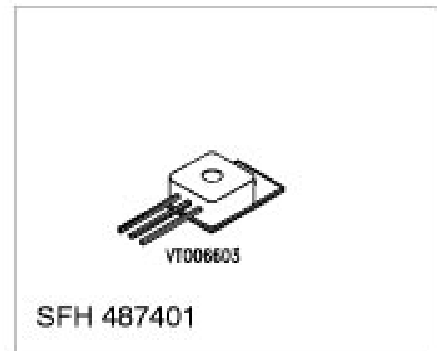

Package: TO 220 - package with antireflecting window SFH 487401 and with FC-connector SFH 487406

Maximum Ratings (continued)

Parameter	Symbol	Value	Unit
Laser Diode			
Storage temperature	T_{stg}	- 40 ... + 70	°C
Maximum lead soldering temperature, 5 s max.	T_S	250	°C

Characteristics ($T_{sub} = 25$ °C)

Parameter	Symbol	Values	Unit
Laser Diode, cw-operations			
Recommended operating temperature	T	- 10 ... + 35	°C
Emission wavelength	λ_{peak}	809 ± 5	nm
Spectral width	$\Delta\lambda$	2	nm
cw-output power SFH 487401 SFH 487406	Φ_{eCW} Φ_{eCW}	1000 ¹⁾ 750 ²⁾	mW mW
Threshold current	I_{th}	450	mA
Differential efficiency ¹⁾ SFH 487401 SFH 487406	η η	0.9 ¹⁾ 0.6 ²⁾	W/A W/A
Operating current SFH 487401 SFH 487406	I_{op} I_{op}	1560 ¹⁾ 1700 ²⁾	mA mA
Operating voltage	V_{op}	2.1	V
Differential serial resistance	r_s	0.3 (≤ 0.4)	Ω
Characteristic temperature for threshold current ³⁾	T_0	150	K
Temperature coefficient of operating current	TC_I	0.5	%/K
Temperature coefficient of wavelength	TC_λ	0.25	nm/K
Thermal resistance; pn-junction - case	R_{thJC}	9	K/W
NTC Thermistor			
Resistance	R_{NTC}	10	kΩ

1) in NA=0.6

2) measured with a fiber NA=0.35, core diameter=125 μm

3) Thermal behaviour of I_{th} can be modeled as $I_{th2} = I_{th1} \exp((T_2 - T_1)/T_0)$

Test certificate

Each laser diode is supplied with technical information about

- Radiant power
- Threshold current
- Differential efficiency
- Operating current and operating voltage
- Emission wavelength

Notes for operation

Overload protection

The specified values apply only as long as the diode is not overloaded.

Pulse spikes from the power supply unit, for example, even if they last only a few nanoseconds may cause irreversible damage to the laser diode. Such spikes may occur when the power supply is turned on or off or they may reach the laser diode from the line via coupling capacitance of electronically controlled devices.

The power supply should therefore be provided with appropriate protection circuits.

Handling of package

It is recommended to observe the same rules as for handling MOS-devices to avoid electro-static induced damage.

Eye protection

This Laser diode is a **Class 4 Laser** product.

For safety measures refer to the relevant safety regulations.

Mounting Notes TO 220

1. Mechanical attachment

1.1. Mounting hole (suitable for M 2.5)

Because of the good thermal conductivity of the TO 220 base (material: copper), the heat loss that is produced is properly dissipated even if the component is only attached on one side.

1.2. For exact positioning of the TO component, like when attaching other parts, e.g. lenses, separately from the Laser, it is possible to attach the TO 220 package additionally with an appropriate clamping device or by screws (max. M 2.5).

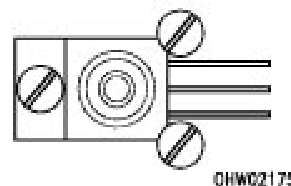
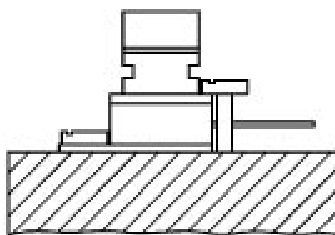

2. Soldering

When soldering the TO base to a heatsink, observe the following guidelines:

- Max. soldering temperature: 125 °C
- Max. soldering duration: 1 min
- Suggested solder: Sn/In (melting point: 117 °C)

Optical Characteristics ($T_{sub} = 25\text{ }^{\circ}\text{C}$)

Radiant power $\Phi_{opt} = f(I_F)$

SFH 487401

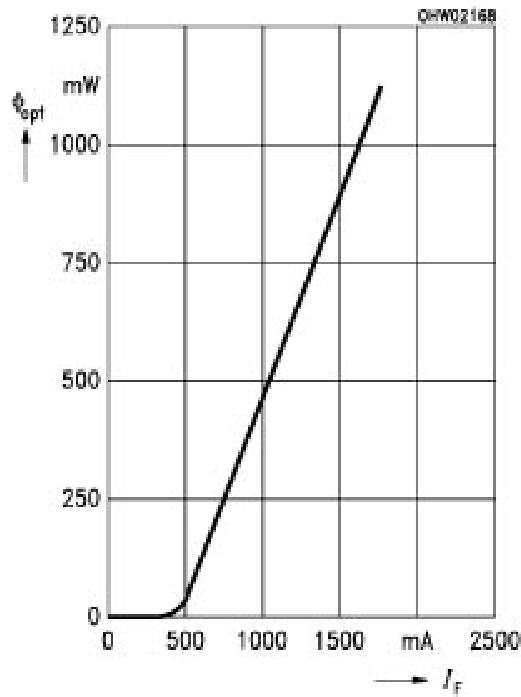

Radiant power $\Phi_{opt} = f(I_F)$

SFH 487406

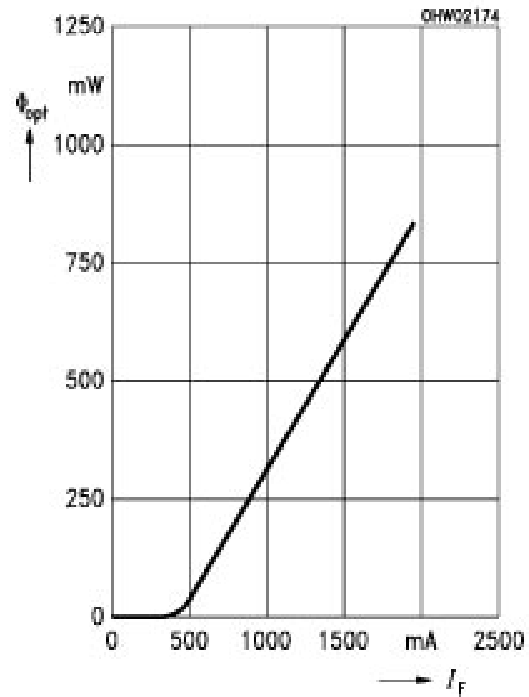

Mode spectrum $I_{rel} = f(\lambda)$

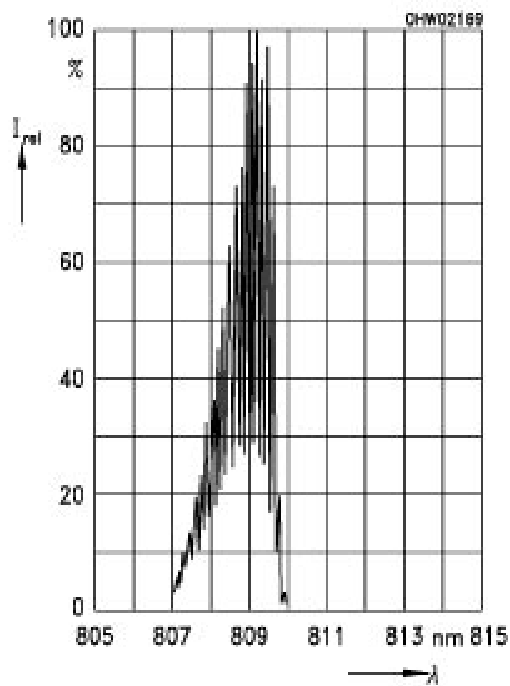

Farfield distribution $I_{rel} = f(\varphi)$
parallel to pn-junction
SFH 487401

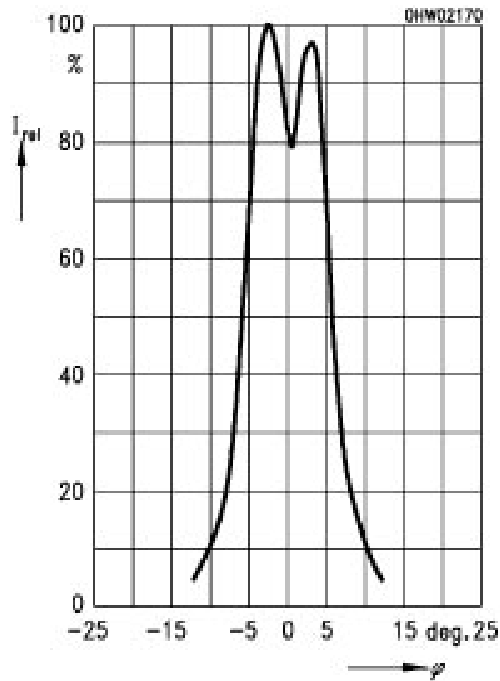

Farfield distribution $I_{rel} = f(\varphi)$
perpendicular to pn-junction
SFH 487401

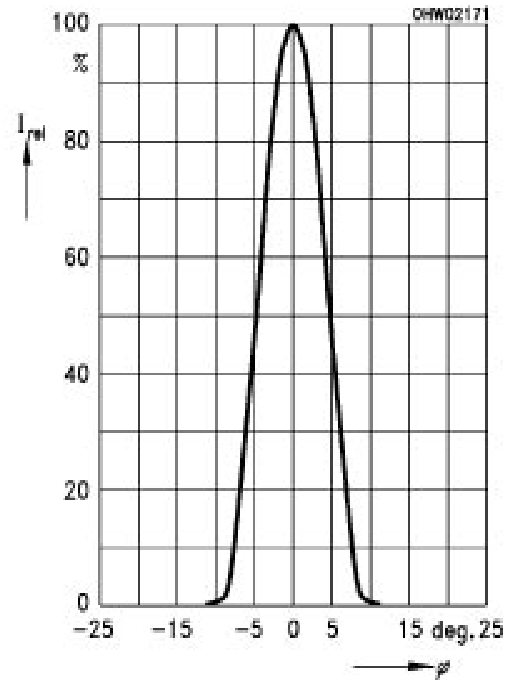

NTC Thermistor $R_T = f(T_A)$
 $R_{T=25^\circ C} = 10\text{ k}\Omega \pm 1\%$

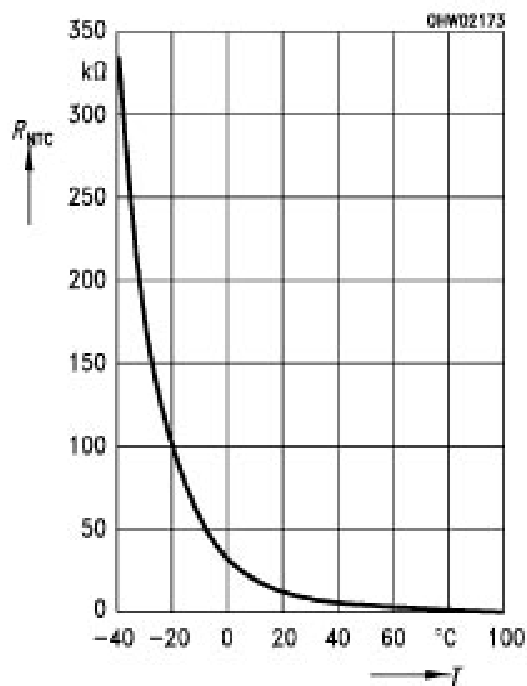

Maßzeichnung
Package Outlines

