

TOSHIBA POWER MOS FET MODULE SILICON N & P CHANNEL MOS TYPE (L²-π-MOSIV 6 IN 1)

MP6801

HIGH POWER, HIGH SPEED SWITCHING APPLICATIONS.

3-PHASE MOTOR DRIVE AND BIPOLAR DRIVE OF PULSE MOTOR.

- 4-Volt Gate Drive.
- Package with Heat Sink Isolated to Lead. (SIP 12Pin)
- High Drain Power Dissipation.
: P_T=40W @T_c=25°C (6 Device Operation)
- Low Drain-Source ON Resistance
: R_{DS(ON)}=55mΩ (Typ.) (N-ch)
90mΩ (Typ.) (P-ch)
- Low Leakage Current : I_{GSS}= ±10μA (Max.) @V_{DS}= ±16V
: I_{DSS}=100μA (Max.) @V_{DS}=60V
- Enhancement-Mode : V_{th}=0.8~2.0V @I_D=1mA

MAXIMUM RATINGS (Ta = 25°C)

CHARACTERISTIC	SYMBOL	RATING		UNIT
		N-ch	P-ch	
Drain-Source Voltage	V _{DSS}	60	-60	V
Gate-Source Voltage	V _{GSS}	±20	±20	V
Drain Current	I _D	10	-10	A
Peak Drain Current	I _{DP}	30	-30	
Drain Power Dissipation (1 Device Operation, Ta = 25°C)	P _D	3.0		W
Drain Power Dissipation (6 Devices Operation)	P _T	5.0		W
		40		
Channel Temperature	T _{ch}	150		°C
Storage Temperature Range	T _{stg}	-55~150		°C

THERMAL CHARACTERISTICS

CHARACTERISTIC	SYMBOL	MAX.	UNIT
Thermal Resistance of Junction to Ambient (6 Devices Operation, Ta = 25°C)	ΣR _{th(j-a)}	25	°C / W
Thermal Resistance of Junction to Case (6 Devices Operation, Tc = 25°C)	ΣR _{th(j-e)}	3.12	°C / W
Maximum Lead Temperature for Soldering Purposes (3.2mm from Case for 10s)	T _L	260	°C

This transistor is an electrostatic sensitive device. Please handle with caution.

INDUSTRIAL APPLICATIONS

Unit in mm

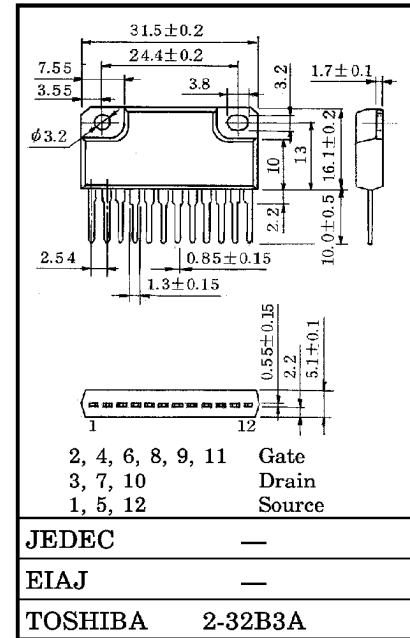

Weight : 6g

ARRAY CONFIGURATION

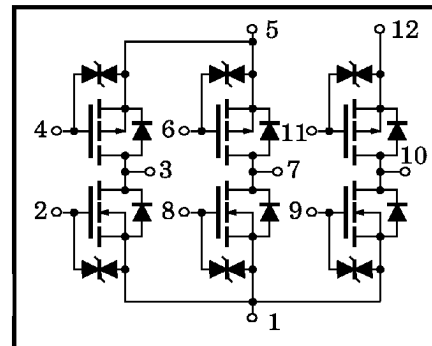

961001EAA2

● TOSHIBA is continually working to improve the quality and the reliability of its products. Nevertheless, semiconductor devices in general can malfunction or fail due to their inherent electrical sensitivity and vulnerability to physical stress. It is the responsibility of the buyer, when utilizing TOSHIBA products, to observe standards of safety, and to avoid situations in which a malfunction or failure of a TOSHIBA product could cause loss of human life, bodily injury or damage to property. In developing your designs, please ensure that TOSHIBA products are used within specified operating ranges as set forth in the most recent products specifications. Also, please keep in mind the precautions and conditions set forth in the TOSHIBA Semiconductor Reliability Handbook.

ELECTRICAL CHARACTERISTICS (Ta = 25°C) (N-ch MOS FET)

CHARACTERISTIC		SYMBOL	TEST CONDITION	MIN.	TYP.	MAX.	UNIT
Gate Leakage Current		I_{GSS}	$V_{GS} = \pm 16V, V_{DS} = 0$	—	—	± 10	μA
Drain Cut-off Current		I_{DSS}	$V_{DS} = 60V, V_{GS} = 0$	—	—	100	μA
Drain-Source Breakdown Voltage		$V_{(BR)DSS}$	$I_D = 10mA, V_{GS} = 0$	60	—	—	V
Gate Threshold Voltage		V_{th}	$V_{DS} = 10V, I_D = 1mA$	0.8	—	2.0	V
Forward Transfer Admittance		$ Y_{fs} $	$V_{DS} = 10V, I_D = 5A$	5	11	—	S
Drain-Source ON Resistance		$R_{DS(ON)}$	$I_D = 5A, V_{GS} = 4V$	—	80	115	m Ω
Drain-Source ON Resistance		$R_{DS(ON)}$	$I_D = 5A, V_{GS} = 10V$	—	55	80	
Input Capacitance		C_{iss}	$V_{DS} = 10V, V_{GS} = 0, f = 1MHz$	—	750	—	pF
Reverse Transfer Capacitance		C_{rss}		—	170	—	
Output Capacitance		C_{oss}		—	450	—	
Switching Time	Rise Time	t_r	<p>$V_{IN} : t_r, t_f < 5ns$ $Du. \leq 1\% (Z_{OUT} = 50\Omega)$</p>	—	60	—	ns
	Turn-on Time	t_{on}		—	80	—	
	Fall Time	t_f		—	150	—	
	Turn-off Time	t_{off}		—	400	—	
Total Gate Charge (Gate-Source Plus Gate-Drain)		Q_g	$I_D = 10A, V_{GS} = 10V$ $V_{DD} = 48V$	—	30	—	nC
Gate-Source Charge		Q_{gs}		—	20	—	
Gate-Drain ("Miller") Charge		Q_{gd}		—	10	—	

SOURCE-DRAIN DIODE RATING AND CHARACTERISTICS (Ta = 25°C)

CHARACTERISTIC	SYMBOL	TEST CONDITION	MIN.	TYP.	MAX.	UNIT
Drain Reverse Current	I_{DR}	—	—	—	-10	A
Peak Drain Reverse Current	I_{DRP}	—	—	—	-30	A
Diode Forward Voltage	V_{DSF}	$I_{DR} = 10A, V_{GS} = 0$	—	-1.0	-1.7	V
Reverse Recovery Time	t_{rr}	$I_{DR} = 10A, V_{GS} = 0$	—	110	—	ns
Reverse Recovery Charge	Q_{rr}	$dI_{DR} / dt = -50A / \mu s$	—	0.27	—	μC

961001EAA2'

- The information contained herein is presented only as a guide for the applications of our products. No responsibility is assumed by TOSHIBA CORPORATION for any infringements of intellectual property or other rights of the third parties which may result from its use. No license is granted by implication or otherwise under any intellectual property or other rights of TOSHIBA CORPORATION or others.
- The information contained herein is subject to change without notice.

ELECTRICAL CHARACTERISTICS (Ta = 25°C) (P-ch MOS FET)

CHARACTERISTIC		SYMBOL	TEST CONDITION	MIN.	TYP.	MAX.	UNIT
Gate Leakage Current		I_{GSS}	$V_{GS} = \pm 16V, V_{DS} = 0$	—	—	± 10	μA
Drain Cut-off Current		I_{DSS}	$V_{DS} = -60V, V_{GS} = 0$	—	—	-100	μA
Drain-Source Breakdown Voltage		$V_{(BR)DSS}$	$I_D = -10mA, V_{GS} = 0$	-60	—	—	V
Gate Threshold Voltage		V_{th}	$V_{DS} = -10V, I_D = -1mA$	-0.8	—	-2.0	V
Forward Transfer Admittance		$ Y_{fs} $	$V_{DS} = -10V, I_D = -5A$	3.5	8.0	—	S
Drain-Source ON Resistance		$R_{DS(ON)}$	$I_D = -5A, V_{GS} = -4V$	—	145	200	m Ω
Drain-Source ON Resistance		$R_{DS(ON)}$	$I_D = -5A, V_{GS} = -10V$	—	90	125	
Input Capacitance		C_{iss}	$V_{DS} = -10V, V_{GS} = 0,$ $f = 1MHz$	—	1200	—	pF
Reverse Transfer Capacitance		C_{rss}		—	220	—	
Output Capacitance		C_{oss}		—	550	—	
Switching Time	Rise Time	t_r		—	60	—	ns
	Turn-on Time	t_{on}		—	80	—	
	Fall Time	t_f		—	120	—	
	Turn-off Time	t_{off}		$V_{IN} : t_r, t_f < 5ns$ $Du. \leq 1\% (Z_{OUT} = 50\Omega)$	—	350	
Total Gate Charge (Gate-Source Plus Gate-Drain)		Q_g	$I_D = -10A, V_{GS} = -10V$	—	45	—	nC
Gate-Source Charge		Q_{gs}	$V_{DD} = -48V$	—	30	—	
Gate-Drain (“Miller”) Charge		Q_{gd}		—	15	—	

SOURCE-DRAIN DIODE RATING AND CHARACTERISTICS (Ta = 25°C)

CHARACTERISTIC	SYMBOL	TEST CONDITION	MIN.	TYP.	MAX.	UNIT
Drain Reverse Current	I_{DR}	—	—	—	-10	A
Peak Drain Reverse Current	I_{DRP}	—	—	—	-30	A
Diode Forward Voltage	V_{DSF}	$I_{DR} = -10A, V_{GS} = 0$	—	-0.9	-1.7	V
Reverse Recovery Time	t_{rr}	$I_{DR} = -10A, V_{GS} = 0$	—	110	—	ns
Reverse Recovery Charge	Q_{rr}	$dI_{DR} / dt = 50A / \mu s$	—	0.18	—	μC

N-ch

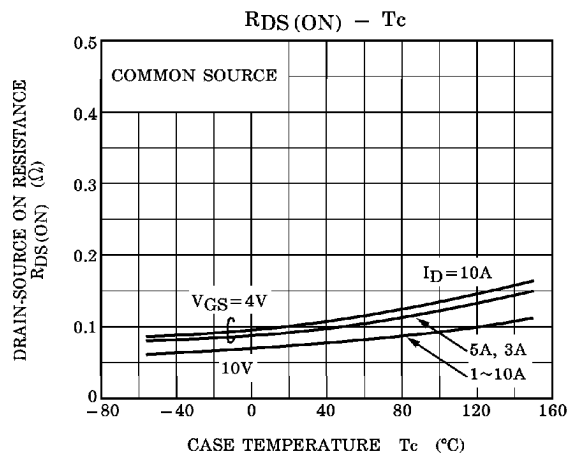
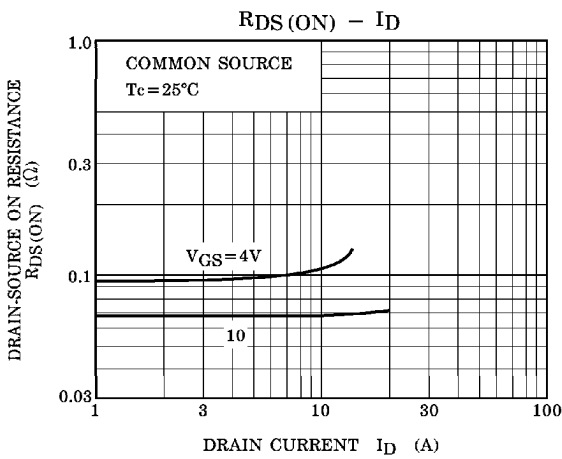
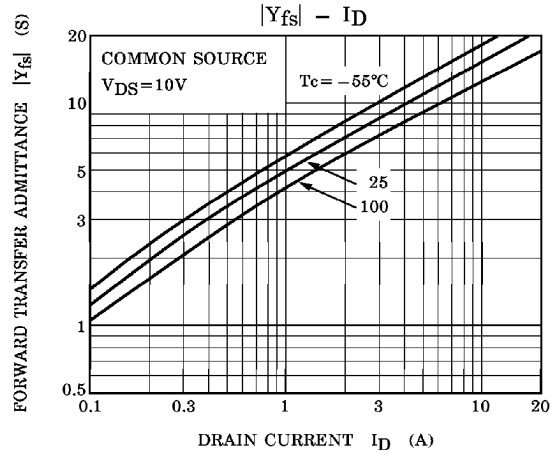
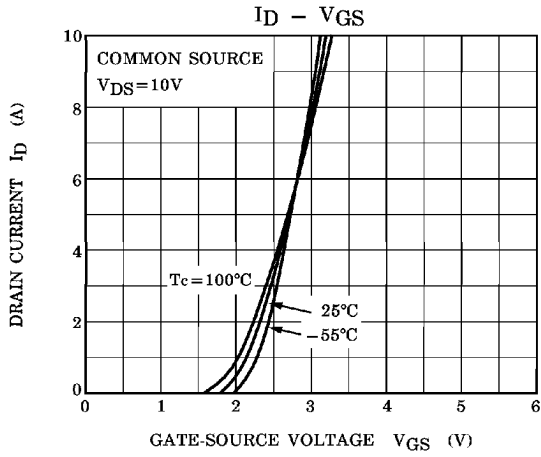
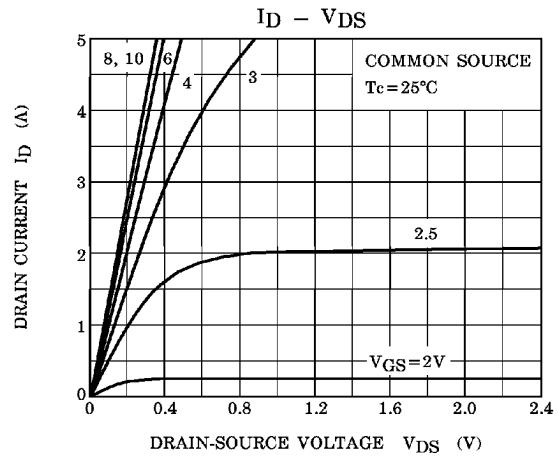
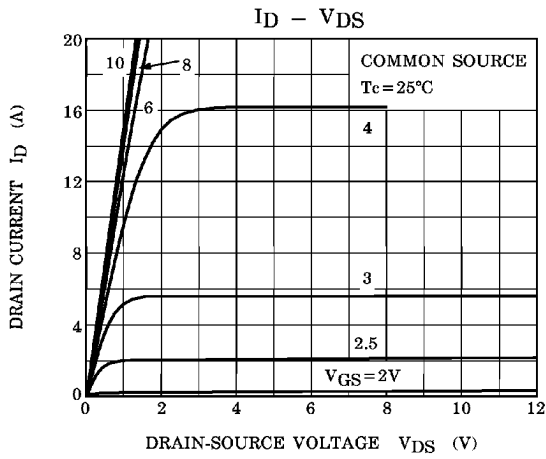

N-ch

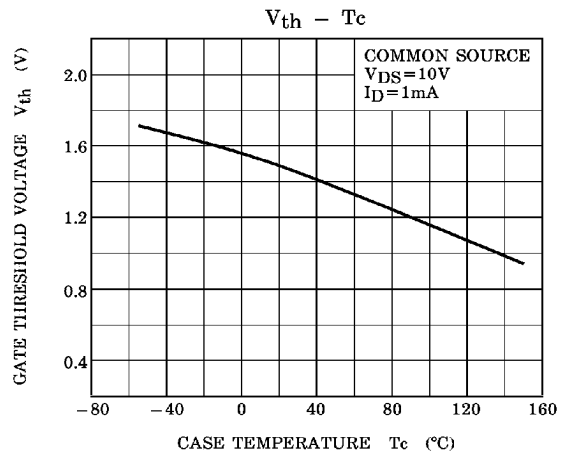
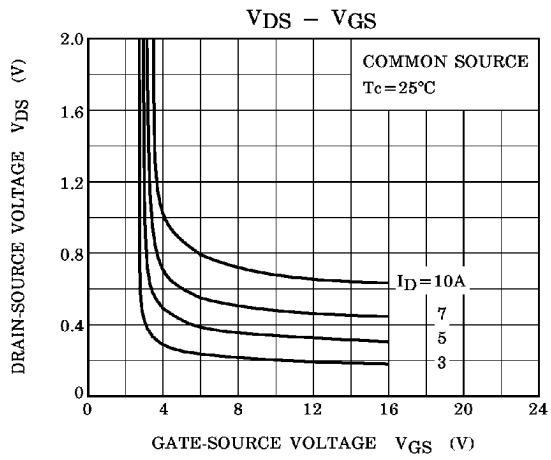
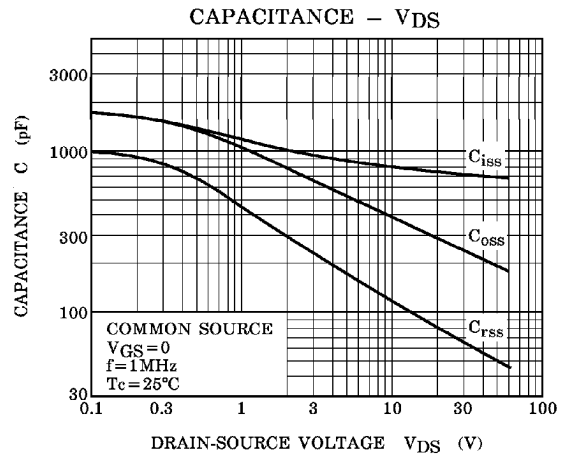
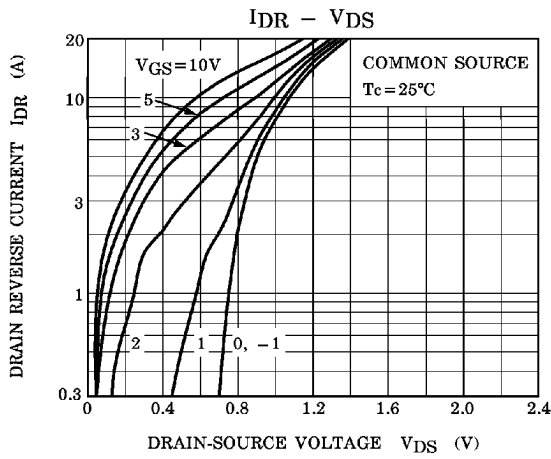

P-ch

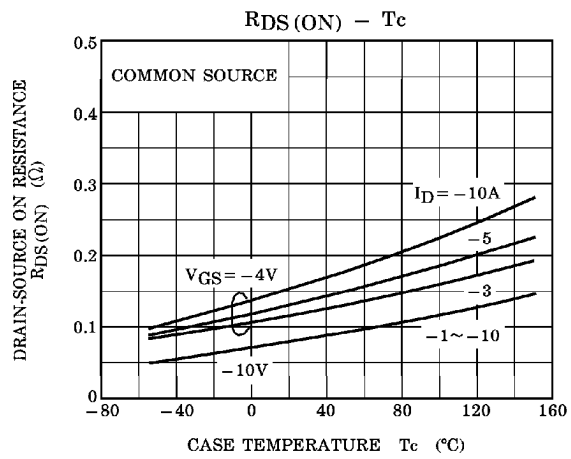
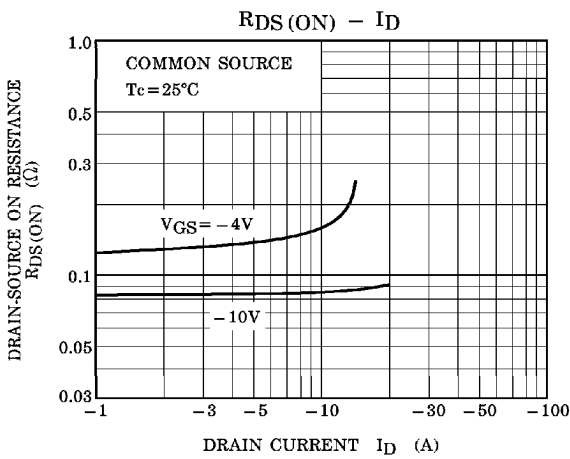
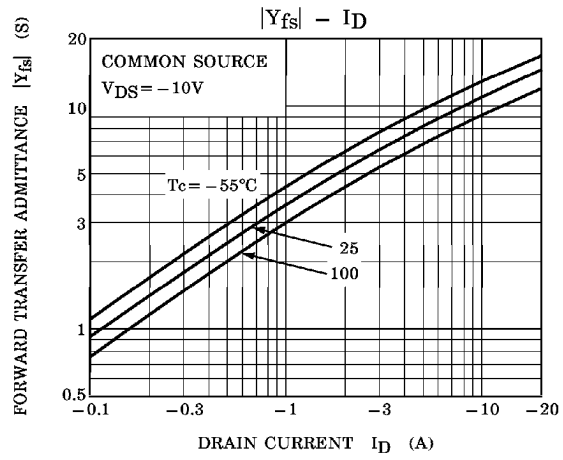
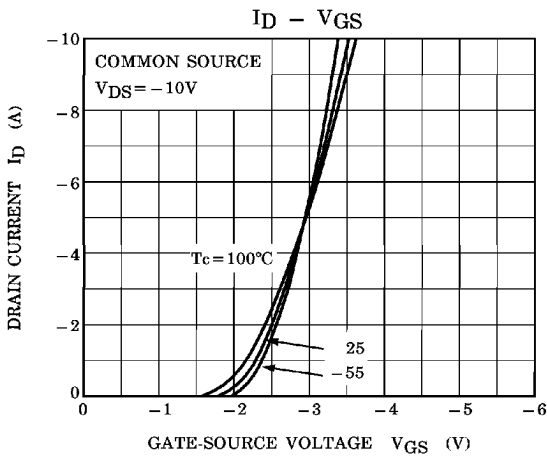
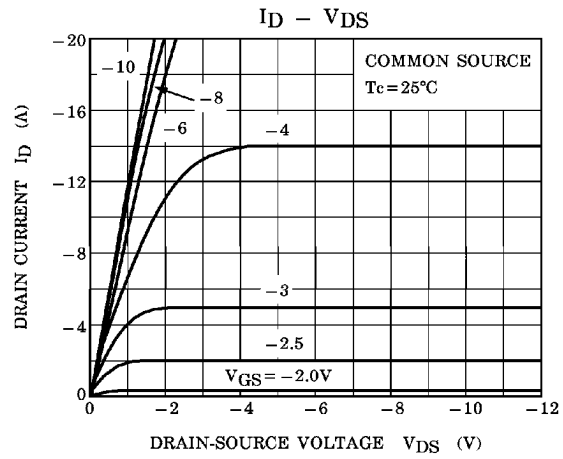
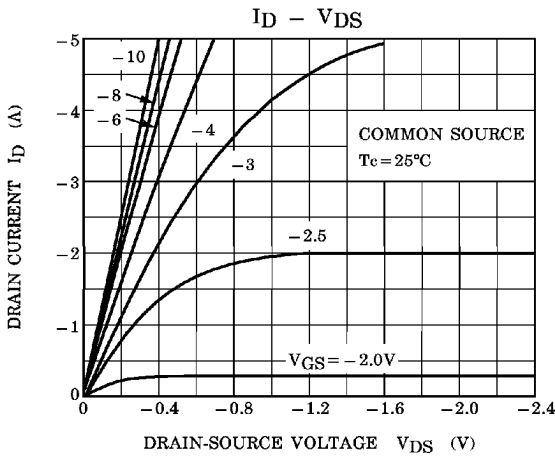

P-ch

