

## DUAL H BRIDGE DRIVER

### ■ GENERAL DESCRIPTION

The NJM2670 is a general-purpose 60V dual H-bridge drive IC. It consists of a pair of H-bridges, a thermal shut down circuit and its alarm output. The alarm output can detect application problems and the system reliability will be significantly improved if monitored by Micro Processor.

Therefore, it is suitable for two-phase stepper motor application driven by microprocessor.

### ■ PACKAGE OUTLINE

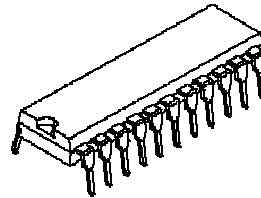

NJM2670D2

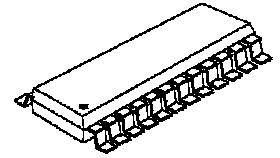

NJM2670E3

### ■ FEATURES

- Wide Voltage Range (4V to 60V)
- Wide Range of Current Control (5 to 1500mA)
- Thermal overload Protection
- Dead Band Protector
- Package Outline (DIP-22, EMP-24)

### ■ PIN CONNECTION

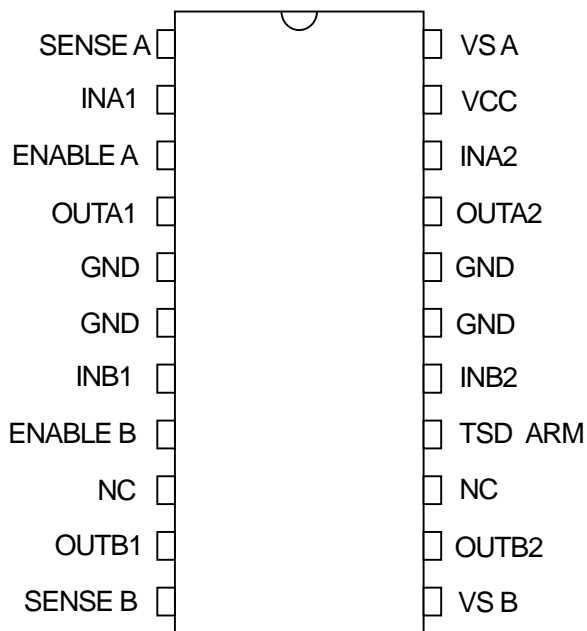

DIP-22

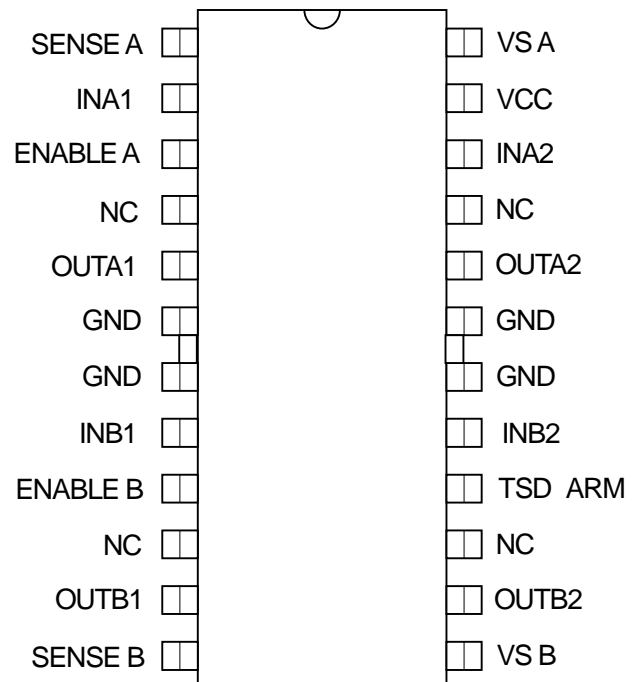

EMP-24

# NJM2670

## ■ BLOCK DIAGRAM

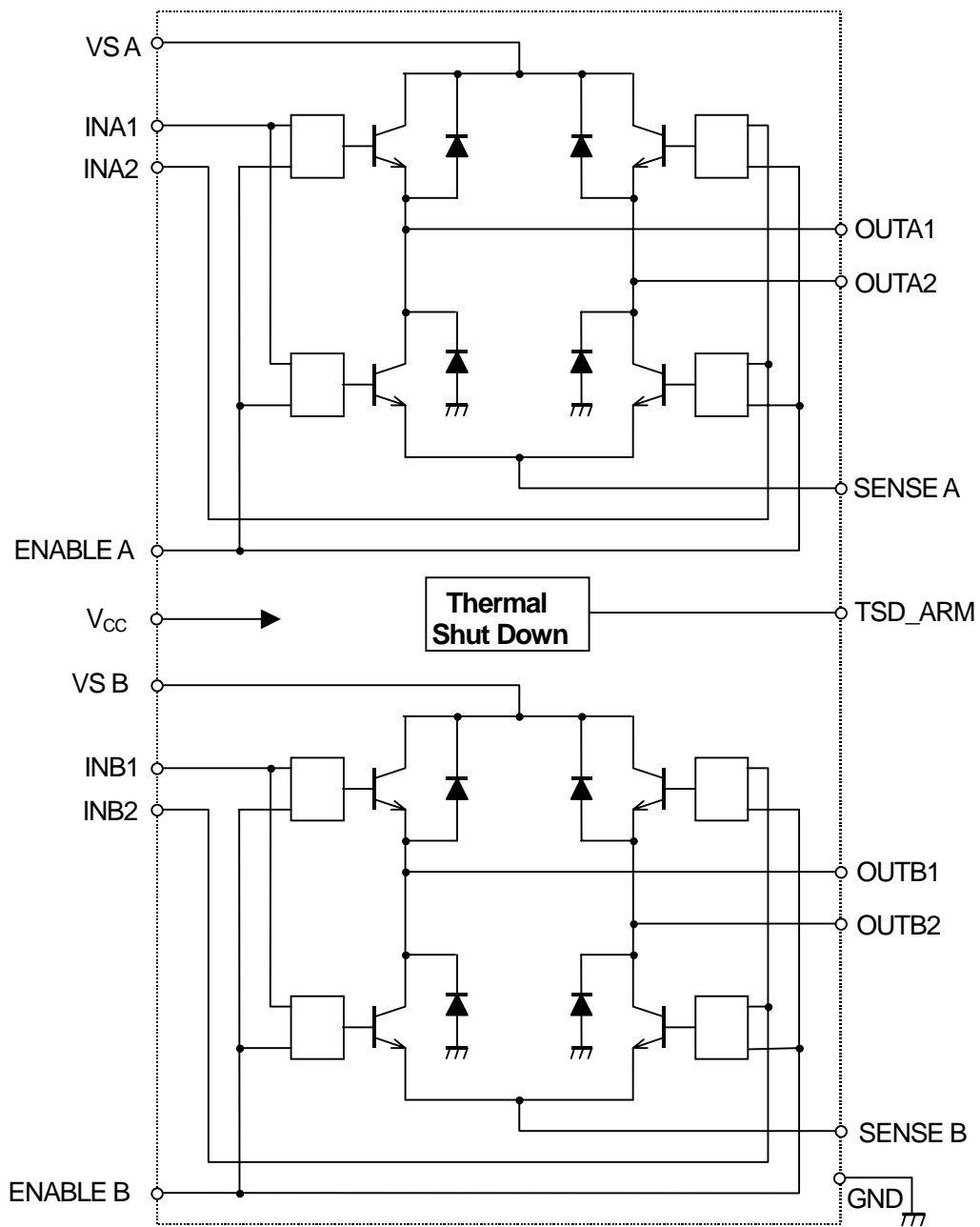

## ■ ABSOLUTE MAXIMUM RATINGS (Ta=25°C )

PARAMETER	SYMBOL	RATINGS	UNIT
Maximum Supply Voltage	V <sub>MM</sub>	60	V
Logic Supply Voltage	V <sub>CC</sub>	7	V
Input Voltage Range	V <sub>IN</sub>	-0.3 to 7	V
Output Current	I <sub>OUT</sub>	1.5	A
Power Dissipation@T(GND)=25°C	P <sub>D25</sub>	5	W
Power Dissipation@T(GND)=125°C	P <sub>D125</sub>	2	W
Operating Junction Temperature	T <sub>opr</sub>	-40 ~ 85	°C
Storage Temperature	T <sub>stg</sub>	-55 ~ 150	°C

## ■ RECOMENENDO OPERATING CONDITIONS

PARAMETER	SYMBOL	TEST CONDITIONS	MIN.	TYP.	MAX.	UNIT
Supply Voltage	V <sub>MM</sub>		4	-	55	V
Logic Voltage Range	V <sub>CC</sub>		4.75	5.00	5.25	V
Maximum Output Current	I <sub>OUT</sub>		-	-	1.3	A
Total Power Dissipation	P <sub>D</sub>	T <sub>GND</sub> =25°C	-	-	5	W
	P <sub>D</sub>	T <sub>GND</sub> =125°C	-	-	2.2	W

## ■ THERMAL CHARACTERISTICS

PARAMETER	SYMBOL	TEST CONDITIONS	MIN.	TYP.	MAX.	UNIT
Thermal resistance	R <sub>thj-GND</sub>	DIP22 package.	-	11	-	°C/W
	R <sub>thj-A</sub>	DIP22 package. Note	-	40	-	°C/W
	R <sub>thj-GND</sub>	EMP24 package.	-	13	-	°C/W
	R <sub>thj-A</sub>	EMP24 package. Note	-	42	-	°C/W

Note : All ground pins soldered onto a 20 cm<sup>2</sup> PCB copper area with free air convection, T<sub>A</sub>=+25°C

# NJM2670

## ■ ELECTRICAL CHARACTERISTICS

PARAMETER	SYMBOL	TEST CONDITIONS	MIN.	TYP.	MAX.	UNIT
GENERAL						
Quiescent current	I <sub>CC</sub>	Enable=H, IN1=IN3=L, IN2=IN4=H	-	40	-	mA
Thermal shutdown	T <sub>SD</sub>		-	170	-	°C
Off-State leak current	I <sub>tsd-LEAK</sub>	TSD ARM=5V	-	-	50	μA
Thermal alarm output saturation	V <sub>tsd</sub>	I <sub>o</sub> =5mA	-	0.5	0.7	V
Dead time protection	T <sub>d</sub>		-	1	-	μs
LOGIC						
Input LOW voltage	V <sub>IL</sub>		-	-	0.6	V
Input HIGH voltage	V <sub>IH</sub>		2	-	-	V
Input HIGH current	I <sub>IH</sub>	V <sub>i</sub> =2.4V	-	-	20	μA
Input LOW current	I <sub>IL</sub>	V <sub>i</sub> =0.4V	-0.4	-	-	mA
OUTPUT						
Upper transistor saturation	V <sub>OU1</sub>	I <sub>o</sub> =1000mA	-	1.3	1.5	V
	V <sub>OU2</sub>	I <sub>o</sub> =1300mA	-	1.5	1.8	V
Lower transistor saturation	V <sub>OL1</sub>	I <sub>o</sub> =1000mA	-	0.5	0.8	V
	V <sub>OL2</sub>	I <sub>o</sub> =1300mA	-	0.8	1.3	V
Upper diode forward	V <sub>IU1</sub>	I <sub>o</sub> =1000mA	-	1.3	1.6	V
	V <sub>IU2</sub>	I <sub>o</sub> =1300mA	-	1.6	1.9	V
Lower diode forward	V <sub>IL1</sub>	I <sub>o</sub> =1000mA	-	1.3	1.6	V
	V <sub>IL2</sub>	I <sub>o</sub> =1300mA	-	1.6	1.9	V
Output leakage current	I <sub>LO-LEAK</sub>	V <sub>MM</sub> =50V	-	-	1	mA
Upper diode recovery time	T <sub>rrU</sub>		-	250	-	ns
Lower diode recovery time	T <sub>rrL</sub>		-	250	-	ns

## ■ TRUTH TABLE

INPUT (L=Low, H=High, X=Don't care)			OUTPUT (H=Source, L=Sink)		OUTPUT mode
ENABLE A=H ENABLE B=H	INA1 INB1	INA2 INB2	OUTA1 OUTB1	OUTA2 OUTB2	
	L	L	L	L	short break mode
	L	H	L	H	CW
	H	L	H	L	CCW
	H	H	H	H	short break mode
ENABLE A=L ENABLE B=L	X	X	All Transistor turned OFF		



# NJM2670

## 3) Current Control Application for Bipolar Stepper Motor

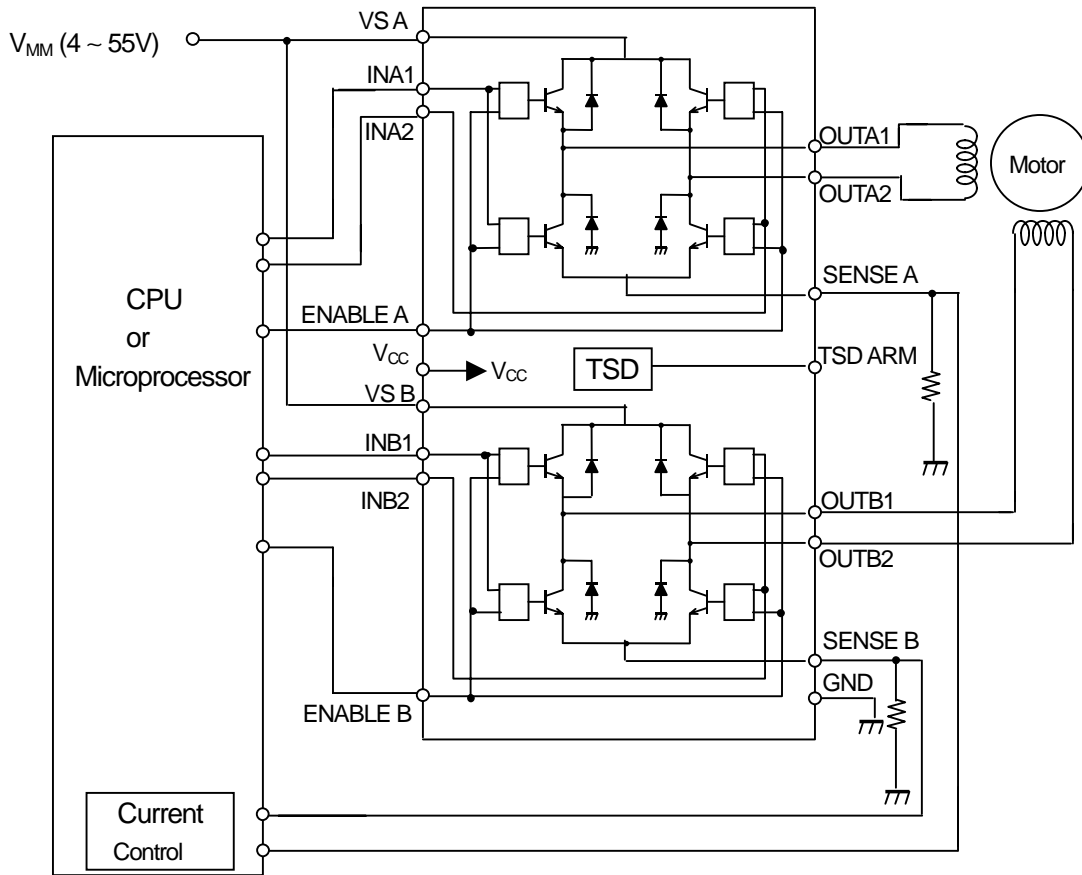

### ■ TIMING CHART

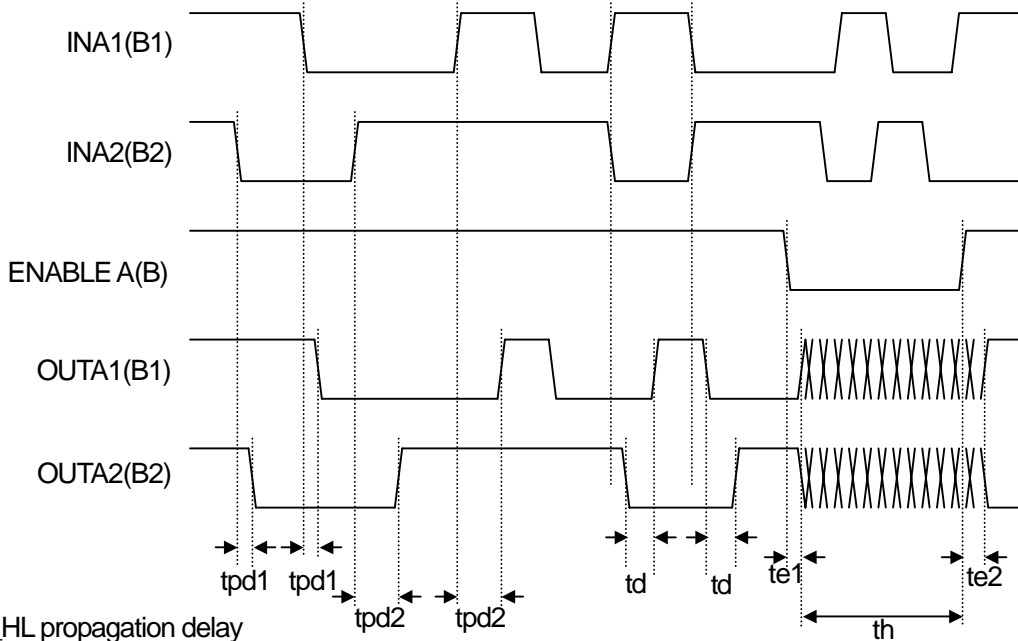

tpd1:IN\_HL propagation delay

tpd2:IN\_LH propagation delay

td :Output dead band protection delay

te1 :ENABLE\_HL propagation delay

te2 :ENABLE\_LH propagation delay

th :Output High impedance section

	Reference value	unit
tpd1	1.0	us
tpd2	2.5	us
td	1.5	us
te1	3.5	us
te2	2.0	us

## TYPICAL APPLICATION 1

### ICC vs. VCC

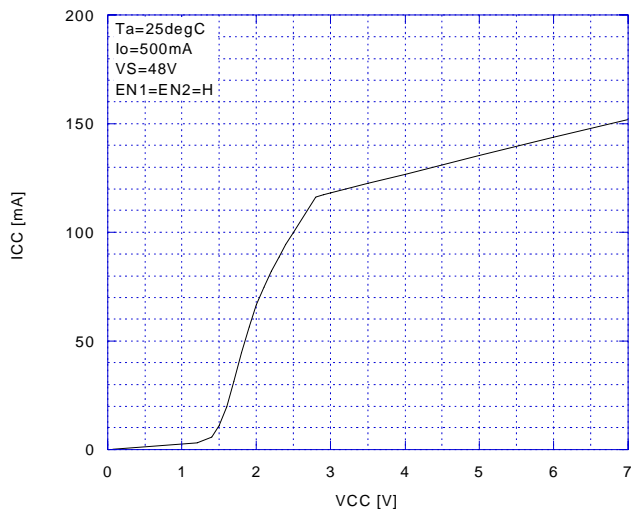

### VIN(INA1)-hysteresis vs. Temperature

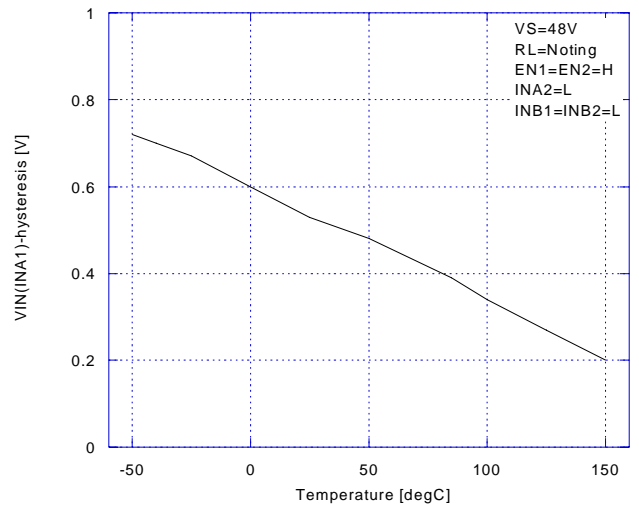

### VIN(INA1) vs. Temperature

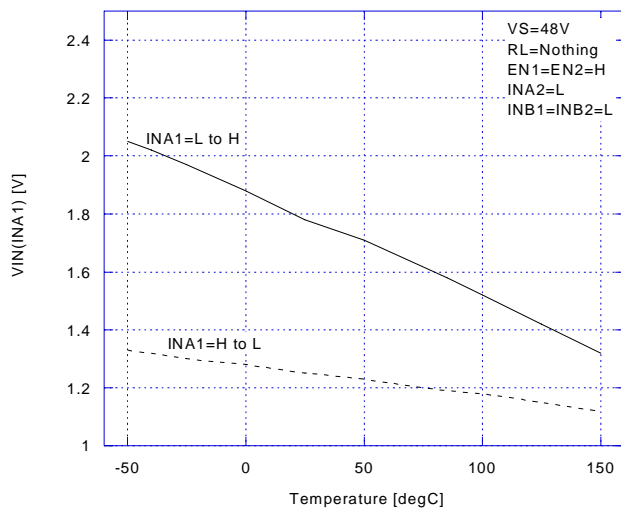

### VIN(INA1)-IB vs. Temperature

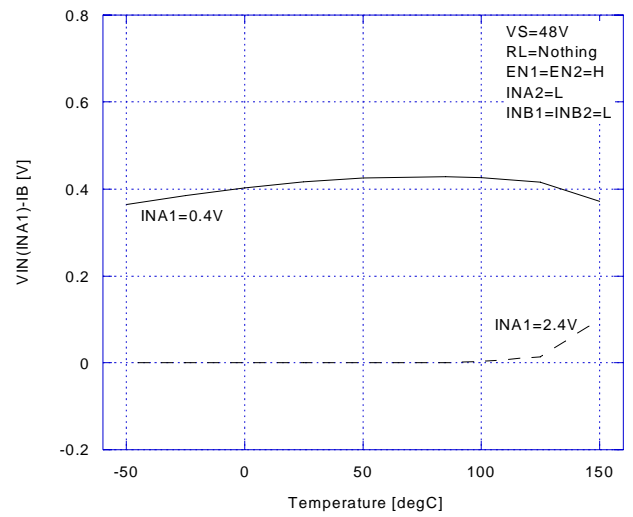

### Vsat(D) vs. Io

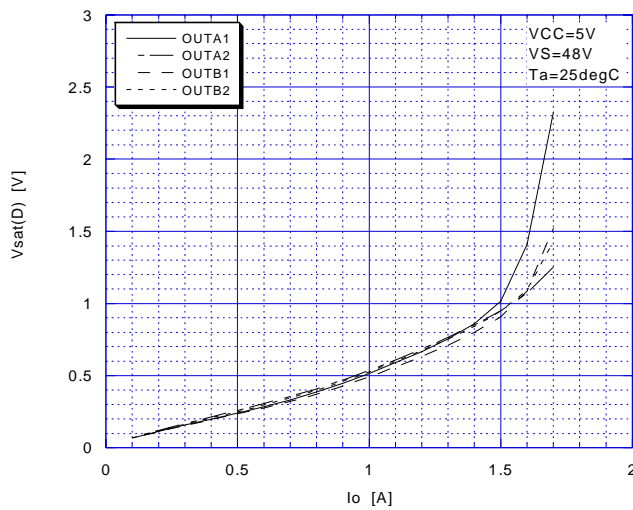

### Vsat(U) vs. Io

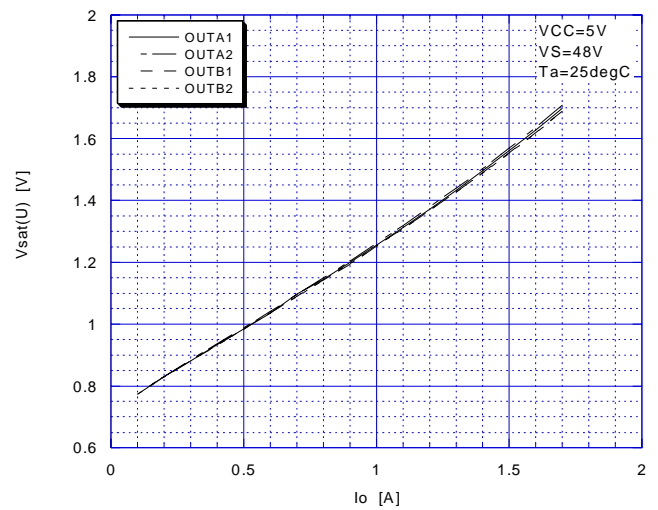

# NJM2670

## TYPICAL APPLICATION 2

Diode(D) vs.  $I_o$

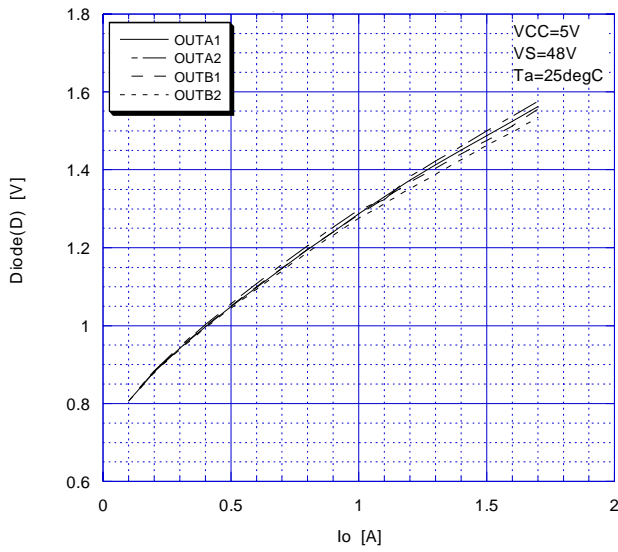

Diode(U) vs.  $I_o$

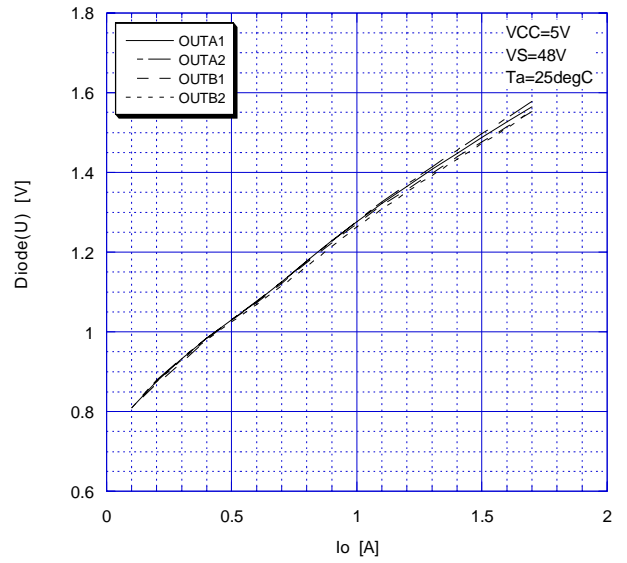

ICC vs. Temperature

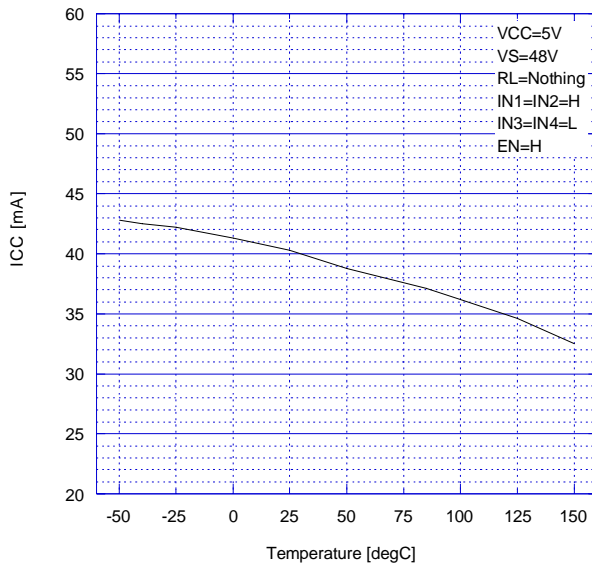

ICC vs. Temperature

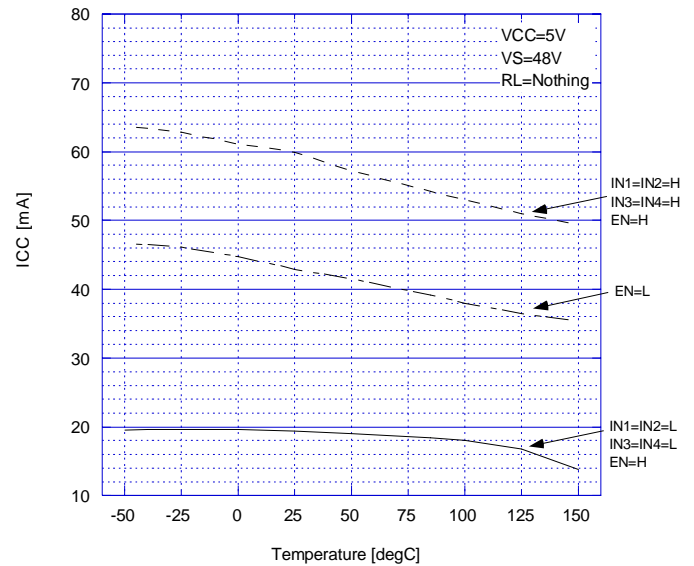

Vsat(D) vs. Temperature

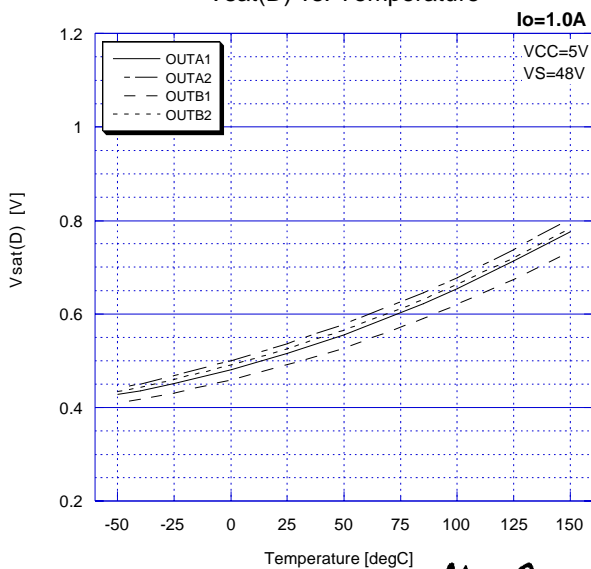

Vsat(U) vs. Temperature

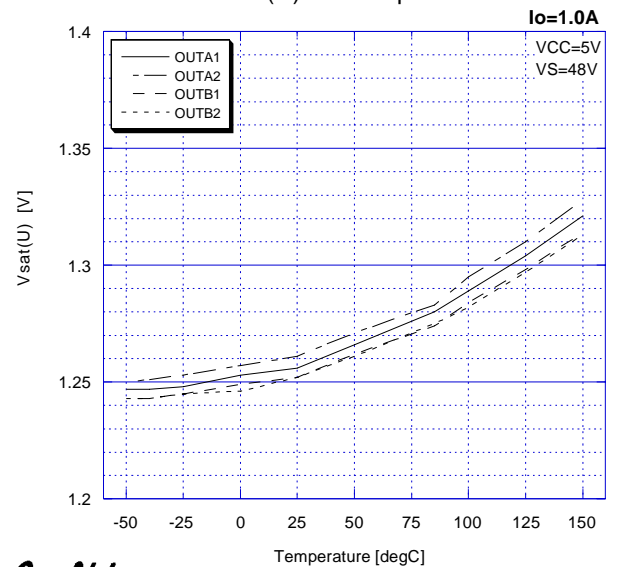



## TYPICAL APPLICATION 3

### Vsat(D) vs. Temperature

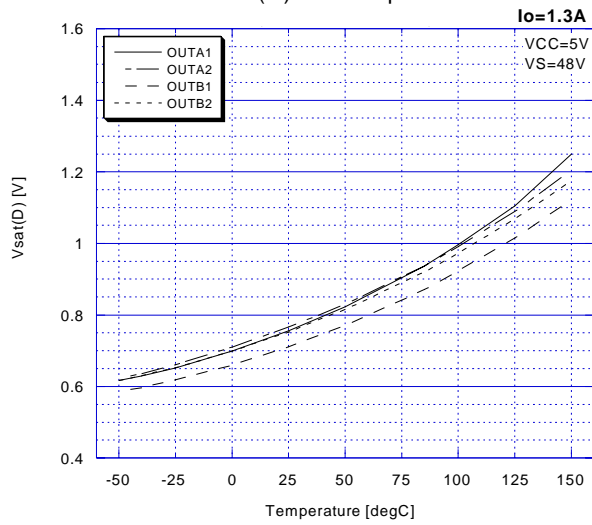

### Vsat(U) vs. Temperature

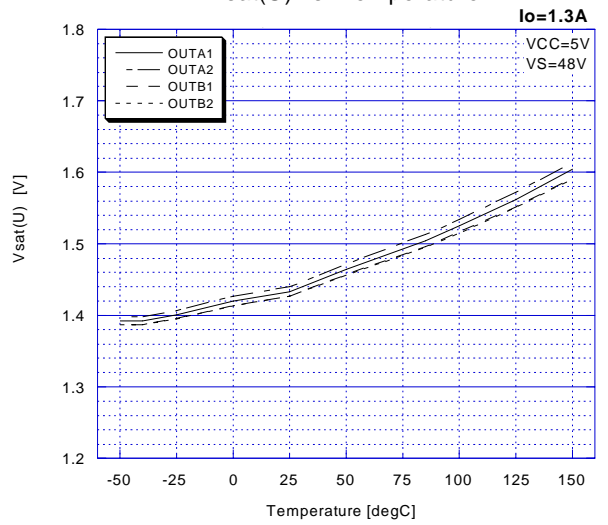

### Diode(D) vs. Temperature

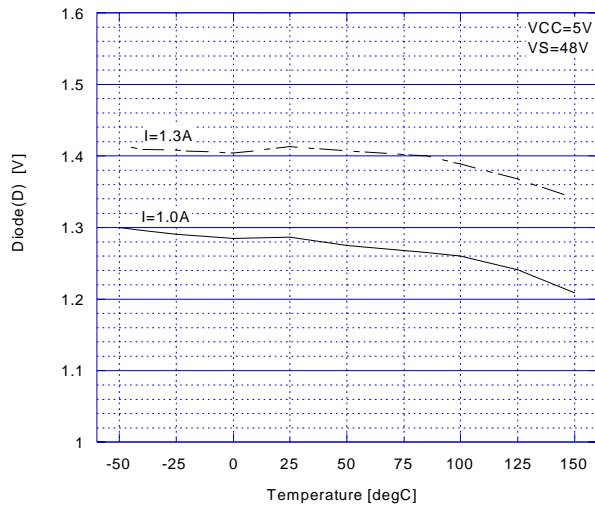

### Diode(U) vs. Temperature

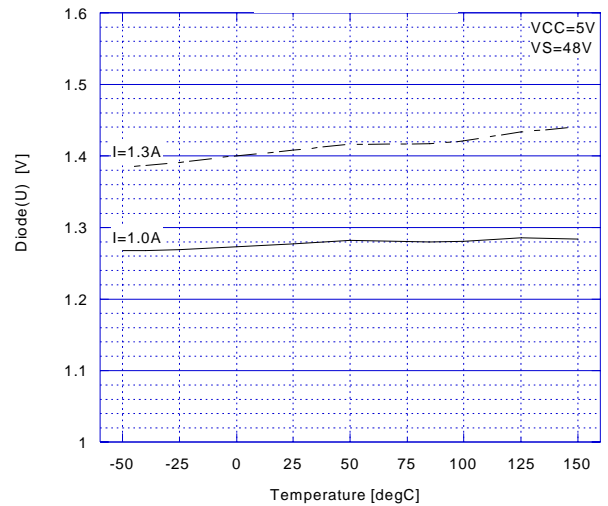

### Diode(U) vs. Temperature

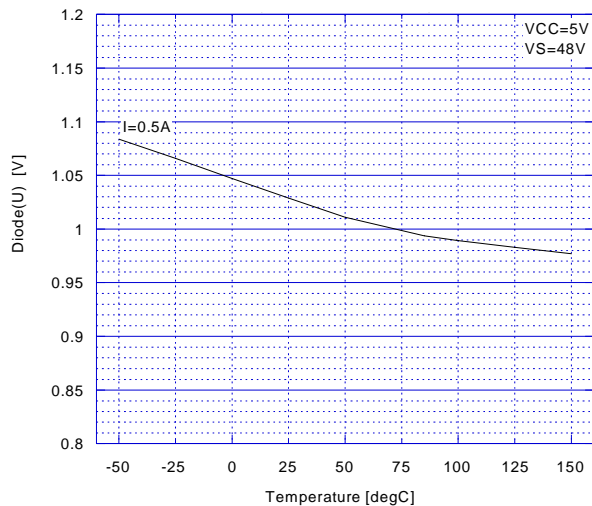

**[CAUTION]**

The specifications on this databook are only given for information, without any guarantee as regards either mistakes or omissions. The application circuits in this databook are described only to show representative usages of the product and not intended for the guarantee or permission of any right including the industrial rights.