

OM6005SC OM6007SC OM6105SC OM6107SC
OM6006SC OM6008SC OM6106SC OM6108SC

POWER MOSFET IN HERMETIC ISOLATED JEDEC TO-258AA PACKAGE

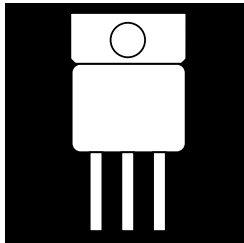

**100V Thru 500V, Up To 35 Amp, N-Channel
MOSFET With Or Without Zener Gate
Clamp Protection**

FEATURES

- Isolated Hermetic Metal Package
- Bi-Lateral Zener Gate Protection (Optional)
- Fast Switching, Low Drive Current
- Ease Of Paralleling For Added Power
- Low $R_{DS(on)}$
- Available Screened To MIL-S-19500, TX, TXV And S Levels

DESCRIPTION

This series of hermetically packaged products feature the latest advanced MOSFET and packaging technology. They are ideally suited for Military requirements where small size, high performance and high reliability are required, and in applications such as switching power supplies, motor controls, inverters, choppers, audio amplifiers and high energy pulse circuits. The MOSFET gates are protected using bi-lateral zener clamps in the OM6105SC series.

MAXIMUM RATINGS

PART NUMBER	V_{DS}	$R_{DS(on)}$	I_D
OM6005SC/OM6105SC	100 V	.065	35 A
OM6006SC/OM6106SC	200 V	.095	30 A
OM6007SC/OM6107SC	400 V	0.3	15 A
OM6008SC/OM6108SC	500 V	0.4	13 A

Note: OM6105SC thru OM6108SC is supplied with zener gate protection.
OM6005SC thru OM6008SC is supplied without zener gate protection.

3.1

SCHEMATIC

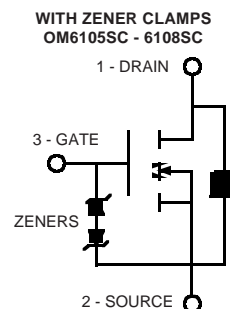
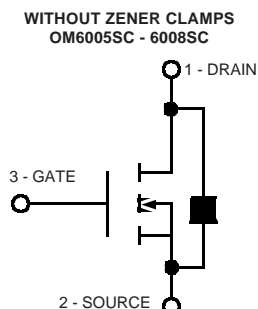

ELECTRICAL CHARACTERISTICS: ($T_C = 25^\circ\text{C}$ unless otherwise noted)
STATIC P/N OM6105SC/OM6005SC (100V)

Parameter	Min.	Typ.	Max.	Units	Test Conditions
BV_{DSS} Drain-Source Breakdown Voltage	100			V	$V_{GS} = 0$, $I_D = 250\text{ mA}$
$V_{GS(th)}$ Gate-Threshold Voltage	2.0		4.0	V	$V_{DS} = V_{GS}$, $I_D = 250\text{ mA}$
I_{GSS} Gate-Body Leakage (OM6105)			± 500	nA	$V_{GS} = \pm 12.8\text{ V}$
I_{GSS} Gate-Body Leakage (OM6005)			± 100	nA	$V_{GS} = \pm 20\text{ V}$
I_{DSS} Zero Gate Voltage Drain Current		0.1	0.25	mA	$V_{DS} = \text{Max. Rat.}$, $V_{GS} = 0$
		0.2	1.0	mA	$V_{DS} = 0.8\text{ Max. Rat.}$, $V_{GS} = 0$, $T_C = 125^\circ\text{ C}$
$I_{D(on)}$ On-State Drain Current ¹	35			A	$V_{DS} = 2 V_{DS(on)}$, $V_{GS} = 10\text{ V}$
$V_{DS(on)}$ Static Drain-Source On-State Voltage ¹		1.1	1.3	V	$V_{GS} = 10\text{ V}$, $I_D = 20\text{ A}$
$R_{DS(on)}$ Static Drain-Source On-State Resistance ¹		0.55	0.65		$V_{GS} = 10\text{ V}$, $I_D = 20\text{ A}$
$R_{DS(on)}$ Static Drain-Source On-State Resistance ¹		.09	0.11		$V_{GS} = 10\text{ V}$, $I_D = 20\text{ A}$, $T_C = 125\text{ C}$

DYNAMIC

g_{fs} Forward Transconductance ¹	9.0	10		S (M)	$V_{DS} = 2 V_{DS(on)}$, $I_D = 20\text{ A}$
C_{iss} Input Capacitance		2700		pF	$V_{GS} = 0$
C_{oss} Output Capacitance		1300		pF	$V_{DS} = 25\text{ V}$
C_{rss} Reverse Transfer Capacitance		470		pF	$f = 1\text{ MHz}$
$t_{d(on)}$ Turn-On Delay Time		28		ns	$V_{DD} = 30\text{ V}$, $I_D @ 20\text{ A}$
t_r Rise Time		45		ns	$R_{\theta} = 5.0\text{ W}$, $V_{GS} = 10\text{ V}$
$t_{d(off)}$ Turn-Off Delay Time		100		ns	
t_f Fall Time		50		ns	

BODY-DRAIN DIODE RATINGS AND CHARACTERISTICS

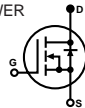
I_S Continuous Source Current (Body Diode)			-40	A	Modified MOSPOWER symbol showing the integral P-N Junction rectifier. 
I_{SM} Source Current ¹ (Body Diode)			-160	A	
V_{SD} Diode Forward Voltage ¹			-2.5	V	$T_C = 25\text{ C}$, $I_S = -40\text{ A}$, $V_{GS} = 0$
t_{rr} Reverse Recovery Time		400		ns	$T_J = 150\text{ C}$, $I_F = I_S$, $di_F/ds = 100\text{ A/ms}$

1 Pulse Test: Pulse Width 300msec, Duty Cycle 2%.

ELECTRICAL CHARACTERISTICS: ($T_C = 25^\circ\text{C}$ unless otherwise noted)
STATIC P/N OM6106SC/OM6006SC (200V)

Parameter	Min.	Typ.	Max.	Units	Test Conditions
BV_{DSS} Drain-Source Breakdown Voltage	200			V	$V_{GS} = 0$, $I_D = 250\text{ mA}$
$V_{GS(th)}$ Gate-Threshold Voltage	2.0		4.0	V	$V_{DS} = V_{GS}$, $I_D = 250\text{ mA}$
I_{GSS} Gate-Body Leakage (OM6106)			± 500	nA	$V_{GS} = \pm 12.8\text{ V}$
I_{GSS} Gate-Body Leakage (OM6006)			± 100	nA	$V_{GS} = \pm 20\text{ V}$
I_{DSS} Zero Gate Voltage Drain Current		0.1	0.25	mA	$V_{DS} = \text{Max. Rat.}$, $V_{GS} = 0$
		0.2	1.0	mA	$V_{DS} = 0.8\text{ Max. Rat.}$, $V_{GS} = 0$, $T_C = 125^\circ\text{ C}$
$I_{D(on)}$ On-State Drain Current ¹	30			A	$V_{DS} = 2 V_{DS(on)}$, $V_{GS} = 10\text{ V}$
$V_{DS(on)}$ Static Drain-Source On-State Voltage ¹		1.36	1.52	V	$V_{GS} = 10\text{ V}$, $I_D = 16\text{ A}$
$R_{DS(on)}$ Static Drain-Source On-State Resistance ¹		.085	.095		$V_{GS} = 10\text{ V}$, $I_D = 16\text{ A}$
$R_{DS(on)}$ Static Drain-Source On-State Resistance ¹		0.14	0.17		$V_{GS} = 10\text{ V}$, $I_D = 16\text{ A}$, $T_C = 125\text{ C}$

DYNAMIC

g_{fs} Forward Transconductance ¹	10.0	12.5		S (M)	$V_{DS} = 2 V_{DS(on)}$, $I_D = 16\text{ A}$
C_{iss} Input Capacitance		2400		pF	$V_{GS} = 0$
C_{oss} Output Capacitance		600		pF	$V_{DS} = 25\text{ V}$
C_{rss} Reverse Transfer Capacitance		250		pF	$f = 1\text{ MHz}$
$t_{d(on)}$ Turn-On Delay Time		25		ns	$V_{DD} = 75\text{ V}$, $I_D @ 16\text{ A}$
t_r Rise Time		60		ns	$R_{\theta} = 5.0\text{ W}$, $V_{GS} = 10\text{ V}$
$t_{d(off)}$ Turn-Off Delay Time		85		ns	
t_f Fall Time		38		ns	

BODY-DRAIN DIODE RATINGS AND CHARACTERISTICS

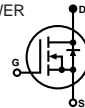
I_S Continuous Source Current (Body Diode)			-30	A	Modified MOSPOWER symbol showing the integral P-N Junction rectifier. 
I_{SM} Source Current ¹ (Body Diode)			-120	A	
V_{SD} Diode Forward Voltage ¹			-2	V	$T_C = 25\text{ C}$, $I_S = -30\text{ A}$, $V_{GS} = 0$
t_{rr} Reverse Recovery Time		350		ns	$T_J = 150\text{ C}$, $I_F = I_S$, $di_F/ds = 100\text{ A/ms}$

1 Pulse Test: Pulse Width 300msec, Duty Cycle 2%.

ELECTRICAL CHARACTERISTICS: ($T_C = 25^\circ\text{C}$ unless otherwise noted)
STATIC P/N OM6107SC/OM6007SC (400V)

Parameter	Min.	Typ.	Max.	Units	Test Conditions
BV_{DSS} Drain-Source Breakdown Voltage	400			V	$V_{GS} = 0$, $I_D = 250\text{ mA}$
$V_{GS(th)}$ Gate-Threshold Voltage	2.0		4.0	V	$V_{DS} = V_{GS}$, $I_D = 250\text{ mA}$
I_{GSS} Gate-Body Leakage (OM6107)			± 500	nA	$V_{GS} = \pm 12.8\text{ V}$
I_{GSS} Gate-Body Leakage (OM6007)			± 100	nA	$V_{GS} = \pm 20\text{ V}$
I_{DSS} Zero Gate Voltage Drain Current		0.1	0.25	mA	$V_{DS} = \text{Max. Rat.}$, $V_{GS} = 0$
		0.2	1.0	mA	$V_{DS} = 0.8\text{ Max. Rat.}$, $V_{GS} = 0$, $T_C = 125^\circ\text{ C}$
$I_{D(on)}$ On-State Drain Current ¹	15			A	$V_{DS} = 2 V_{DS(on)}$, $V_{GS} = 10\text{ V}$
$V_{DS(on)}$ Static Drain-Source On-State Voltage ¹		2.0	2.4	V	$V_{GS} = 10\text{ V}$, $I_D = 8.0\text{ A}$
$R_{DS(on)}$ Static Drain-Source On-State Resistance ¹		0.25	0.3		$V_{GS} = 10\text{ V}$, $I_D = 8.0\text{ A}$
$R_{DS(on)}$ Static Drain-Source On-State Resistance ¹		0.50	0.60		$V_{GS} = 10\text{ V}$, $I_D = 8.0\text{ A}$, $T_C = 125\text{ C}$

DYNAMIC

g_{fs} Forward Transconductance ¹	6.0	9.6		S (M)	$V_{DS} = 2 V_{DS(on)}$, $I_D = 8.0\text{ A}$
C_{iss} Input Capacitance		2900		pF	$V_{GS} = 0$
C_{oss} Output Capacitance		450		pF	$V_{DS} = 25\text{ V}$
C_{rss} Reverse Transfer Capacitance		150		pF	$f = 1\text{ MHz}$
$t_{d(on)}$ Turn-On Delay Time		30		ns	$V_{DD} = 200\text{ V}$, $I_D @ 8.0\text{ A}$
t_r Rise Time		40		ns	$R_{\theta} = 5.0\text{ W}$, $V_{GS} = 10\text{ V}$
$t_{d(off)}$ Turn-Off Delay Time		80		ns	
t_f Fall Time		30		ns	

BODY-DRAIN DIODE RATINGS AND CHARACTERISTICS

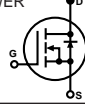
I_S Continuous Source Current (Body Diode)			- 15	A	Modified MOSPOWER symbol showing the integral P-N Junction rectifier. 
I_{SM} Source Current ¹ (Body Diode)			- 60	A	
V_{SD} Diode Forward Voltage ¹			- 1.6	V	$T_C = 25\text{ C}$, $I_S = -15\text{ A}$, $V_{GS} = 0$
t_{rr} Reverse Recovery Time		600		ns	$T_J = 100\text{ C}$, $I_F = I_S$, $dI_F/ds = 100\text{ A/ms}$

1 Pulse Test: Pulse Width 300msec, Duty Cycle 2%.

ELECTRICAL CHARACTERISTICS: ($T_C = 25^\circ\text{C}$ unless otherwise noted)
STATIC P/N OM6108SC/OM6008SC (500V)

Parameter	Min.	Typ.	Max.	Units	Test Conditions
BV_{DSS} Drain-Source Breakdown Voltage	500			V	$V_{GS} = 0$, $I_D = 250\text{ mA}$
$V_{GS(th)}$ Gate-Threshold Voltage	2.0		4.0	V	$V_{DS} = V_{GS}$, $I_D = 250\text{ mA}$
I_{GSS} Gate-Body Leakage (OM6108)			± 500	nA	$V_{GS} = \pm 12.8\text{ V}$
I_{GSS} Gate-Body Leakage (OM6008)			± 100	nA	$V_{GS} = \pm 20\text{ V}$
I_{DSS} Zero Gate Voltage Drain Current		0.1	0.25	mA	$V_{DS} = \text{Max. Rat.}$, $V_{GS} = 0$
		0.2	1.0	mA	$V_{DS} = 0.8\text{ Max. Rat.}$, $V_{GS} = 0$, $T_C = 125^\circ\text{ C}$
$I_{D(on)}$ On-State Drain Current ¹	13			A	$V_{DS} = 2 V_{DS(on)}$, $V_{GS} = 10\text{ V}$
$V_{DS(on)}$ Static Drain-Source On-State Voltage ¹		2.1	2.8	V	$V_{GS} = 10\text{ V}$, $I_D = 7.0\text{ A}$
$R_{DS(on)}$ Static Drain-Source On-State Resistance ¹		0.3	0.4		$V_{GS} = 10\text{ V}$, $I_D = 7.0\text{ A}$
$R_{DS(on)}$ Static Drain-Source On-State Resistance ¹		0.66	0.88		$V_{GS} = 10\text{ V}$, $I_D = 7.0\text{ A}$, $T_C = 125\text{ C}$

DYNAMIC

g_{fs} Forward Transconductance ¹	5.0	7.2		S (M)	$V_{DS} = 2 V_{DS(on)}$, $I_D = 7.0\text{ A}$
C_{iss} Input Capacitance		2600		pF	$V_{GS} = 0$
C_{oss} Output Capacitance		280		pF	$V_{DS} = 25\text{ V}$
C_{rss} Reverse Transfer Capacitance		40		pF	$f = 1\text{ MHz}$
$t_{d(on)}$ Turn-On Delay Time		30		ns	$V_{DD} = 210\text{ V}$, $I_D @ 7.0\text{ A}$
t_r Rise Time		46		ns	$R_{\theta} = 5.0\text{ W}$, $V_{GS} = 10\text{ V}$
$t_{d(off)}$ Turn-Off Delay Time		75		ns	
t_f Fall Time		31		ns	

BODY-DRAIN DIODE RATINGS AND CHARACTERISTICS

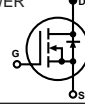
I_S Continuous Source Current (Body Diode)			- 13	A	Modified MOSPOWER symbol showing the integral P-N Junction rectifier. 
I_{SM} Source Current ¹ (Body Diode)			- 52	A	
V_{SD} Diode Forward Voltage ¹			- 1.4	V	$T_C = 25\text{ C}$, $I_S = -13\text{ A}$, $V_{GS} = 0$
t_{rr} Reverse Recovery Time		700		ns	$T_J = 150\text{ C}$, $I_F = I_S$, $dI_F/ds = 100\text{ A/ms}$

1 Pulse Test: Pulse Width 300msec, Duty Cycle 2%.

OM6005SC - OM6108SC

ABSOLUTE MAXIMUM RATINGS ($T_C = 25^\circ\text{C}$ unless otherwise noted)

Parameter		OM6005SC OM6105SC	OM6006SC OM6106SC	OM6007SC OM6107SC	OM6008SC OM6108SC	Units
V_{DS}	Drain-Source Voltage	100	200	400	500	V
V_{DGR}	Drain-Gate Voltage ($R_{GS} = 1\text{ M}$)	100	200	400	500	V
$I_D @ T_C = 25^\circ\text{C}$	Continuous Drain Current ²	± 35	± 30	± 15	± 13	A
$I_D @ T_C = 100^\circ\text{C}$	Continuous Drain Current ²	± 25	± 19	± 9	± 8	A
I_D	Pulsed Drain Current ¹	± 160	± 120	± 60	± 52	A
$P_D @ T_C = 25^\circ\text{C}$	Maximum Power Dissipation	125	125	125	125	W
$P_D @ T_C = 100^\circ\text{C}$	Maximum Power Dissipation	50	50	50	50	W
Junction To Case	Linear Derating Factor ¹	1.0	1.0	1.0	1.0	W/ $^\circ\text{C}$
Junction To Ambient	Linear Derating Factor	.025	.025	.025	.025	W/ $^\circ\text{C}$
T_J	Operating and					
T_{stg}	Storage Temperature Range	-55 to 150	-55 to 150	-55 to 150	-55 to 150	$^\circ\text{C}$
Lead Temperature	(1/16" from case for 10 secs.)	300	300	300	300	$^\circ\text{C}$

1 Pulse Test: Pulse width 300 μsec . Duty Cycle 2%.

2 Package Pin Limitation = 35 Amps

THERMAL RESISTANCE (MAXIMUM) at $T_A = 25^\circ\text{C}$

R_{thJC}	Junction-to-Case	1.0	$^\circ\text{C/W}$
R_{thJA}	Junction-to-Ambient	40	$^\circ\text{C/W}$ Free Air Operation

POWER DERATING

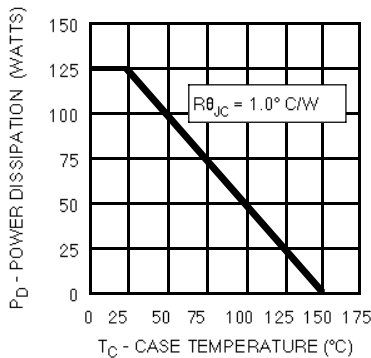

MECHANICAL OUTLINE WITH PIN CONNECTION

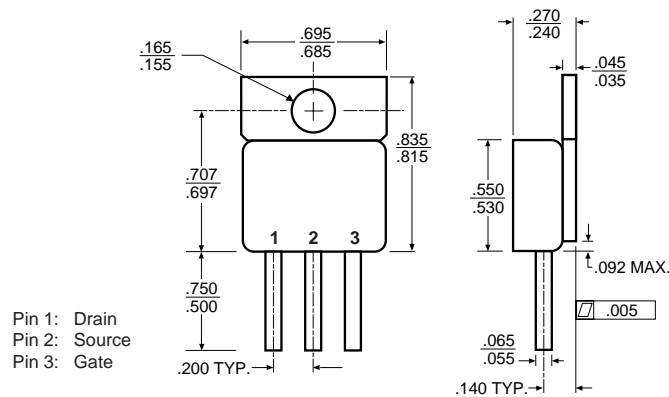

PACKAGE OPTIONS

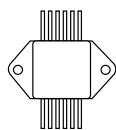

MOD PAK

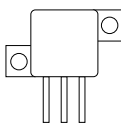

Z-TAB

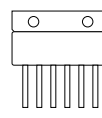

6 PIN SIP

Note: MOSFETs are also available in Z-Tab, dual and quad pak styles. Duals and quads available in non-gate versions only. Please call the factory for more information.