

# MAXIM

## MAX1945 Evaluation Kit

Evaluates: MAX1945

### General Description

The MAX1945 evaluation kit (EV kit) is a fully assembled and tested surface-mount circuit board that contains a high-efficiency step-down switching-regulator circuit for applications requiring on-board postregulation. The circuit utilizes a MAX1945R regulator featuring  $\pm 4\%$  voltage margining and is configured for a 1.8V output voltage. The circuit provides up to 6A of current. A 2.6V to 5.5V DC source can be utilized to power the circuit's input.

The MAX1945R IC features an internal power MOSFET switch and an internal synchronous rectifier. The MAX1945 EV kit provides connections for the SYNC input. It also provides an output to synchronize another MAX1945 EV kit clock 180 degrees out-of-phase. Pulse-width modulated (PWM) operation at 500kHz allows the use of tiny surface-mount components.

### Component List

DESIGNATION	QTY	DESCRIPTION
C1	1	100 $\mu$ F $\pm 20\%$ , 8V polymer capacitor (7.3 x 4.3) Panasonic EEFUE0K101R
C2	1	180 $\mu$ F $\pm 20\%$ , 4V polymer capacitor (7.3 x 4.3) Panasonic EEFUE0G181R
C3, C6, C7	3	0.1 $\mu$ F $\pm 10\%$ , 10V X7R ceramic capacitors (0603) AVX 0603ZC104KAT
C4	1	0.22 $\mu$ F $\pm 10\%$ , 6.3V X7R ceramic capacitor (0603) AVX 06036C224KAT
C5	1	100pF $\pm 5\%$ , 50V COG ceramic capacitor (0603) TDK C1608COG1H101JT
C8	1	1 $\mu$ F $\pm 10\%$ , 16V X7R ceramic capacitor (1206) TDK C3216X7R1C105KT
D1	1	100mA, 30V Schottky diode (SOD-523) Central Semiconductor CMOSH-3
J1	0	Scope probe connector (not installed) FCI 33JR135-1
JU1, JU2, JU3	3	2-pin headers

### Features

- ◆ 0.970in x 0.840in Circuit Footprint
- ◆ 2.6V to 5.5V Input Range
- ◆ Output Voltage
  - 1.8V/2.5V Preset
  - 0.8V to 0.85x VIN Adjustable
- ◆ Provides Up to 6A Output Current
- ◆  $\pm 4\%$  Voltage Margining
- ◆ Internal Power Switch and Synchronous Rectifier
- ◆ 500kHz/1MHz PWM Selectable Switching Frequency
- ◆ SYNC Input: Synchronizes from 400kHz to 1.2MHz TTL/CMOS Clock
- ◆ SYNC Output: Drives 2nd MAX1945 Switching 180 Degrees Out-of-Phase
- ◆ All Surface-Mount Components
- ◆ Fully Assembled and Tested

### Ordering Information

PART	TEMP RANGE	IC PACKAGE
MAX1945EVKIT	0°C to +70°C	28 TSSOP-EP*

\*EP = Exposed pad.

### Quick Start

#### Required Equipment

The following equipment is required before beginning:

- One 2.6V to 5.5V power supply capable of providing 5A
- One voltmeter

The MAX1945 EV kit is fully assembled and tested. Follow these steps to verify board operation. **Do not turn on the power supply until all connections are completed:**

#### 1.8V Output Voltage (Nominal)

- 1) Verify that jumpers JU1 (CTL1) and JU2 (CTL2) do not have shunts across their respective pins.
- 2) Verify that a shunt is across the pins of jumper JU3 (SYNC).
- 3) Verify that jumper JU4 (FBSEL, 1.8V) has a shunt installed across pins 2 and 3.
- 4) Connect the voltmeter to the VOUT and PGND pads.

# MAX1945 Evaluation Kit

## Component List (continued)

DESIGNATION	QTY	DESCRIPTION
JU4	1	3-pin header
L1	1	1.2 $\mu$ H, 9A inductor Sumida CDRH8D43 4783-T010
R1	1	0 $\Omega$ $\pm$ 5% resistor (0603)
R2	0	Not installed, resistor (0603)
R3	1	180k $\Omega$ $\pm$ 5% resistor (0603)
R4	1	10 $\Omega$ $\pm$ 5% resistor (0805)
R5, R6, R7	3	100k $\Omega$ $\pm$ 5% resistors (0603)
U1	1	MAX1945REUI, 28-pin TSSOP-EP
None	4	Shunts (JU1–JU4)
None	1	MAX1945 PC board

- Connect the 2.6VDC to 5.5VDC power supply to the VIN pad. Connect the supply ground to the PGND pad.
- Turn on the power supply and verify that the output voltage at VOUT is 1.8V.

For instructions on selecting the feedback resistors for other output voltages, see the *Evaluating Other Output Voltages* section.

## Detailed Description

The MAX1945 EV kit contains a step-down switching-regulator circuit providing 1.8V and up to 6A at the output. The circuit can be powered from a DC power supply with an input range of 2.6V to 5.5V and supply up to 5A of current.

The circuit utilizes a MAX1945R regulator IC with  $\pm$ 4% voltage margining and is configured for a 1.8V output. The output voltage is set to 1.8V by JU4 (FBSEL), external divider resistor R1, and the MAX1945R internal resistor-dividers. The output can be reconfigured for other output voltages. The voltage margining and shut-

down features are controlled by two multifeature jumpers (JU1, JU2). The output voltage can be configured to operate at 1.8V (nominal), 1.87V (+4%), or 1.73V (-4%).

The MAX1945R IC in a TSSOP-EP package features an internal power MOSFET switch and an internal synchronous rectifier. The EV kit's four-layer PC board has copper pads under the IC and vias connecting to the PGND layer (layer 2) to dissipate heat away from the IC. This enables the EV kit to operate at high current ratings.

The MAX1945 EV kit is configured to switch at 500kHz. The EV kit can be reconfigured to switch at 1MHz or use an external TTL/CMOS digital clock source. PC board pads are provided for the MAX1945 IC's SYNC input and SYNCOUT signals. A second MAX1945 EV kit's SYNC input can be fed from the SYNCOUT signal. This enables the second MAX1945 to switch 180 degrees out-of-phase relative to the first MAX1945R IC.

An oscilloscope jack (J1) can be installed on the EV kit to obtain accurate voltage transient response and output ripple measurement. Obtain the jack from the manufacturer listed in the *Component List* for Designation J1.

## Jumper Selection

### Shutdown Mode/Voltage Margining Control

The MAX1945 EV kit has two jumpers providing multifeature configurations. JU1 and JU2 configure the shutdown mode that reduces the MAX1945 quiescent current and voltage-margining modes. The voltage-margining modes allow the output to be shifted to a higher or lower supply tolerance. Table 1 lists the selectable jumper options for the shutdown and voltage-margining modes.

### Synchronization and Frequency Selection

The MAX1945 EV kit provides a jumper to select the switching frequency of the MAX1945R IC. Additionally, the MAX1945R can be synchronized to an external

## Component Suppliers

SUPPLIER	PHONE	FAX	WEBSITE
AVX	843-946-0238	843-626-3123	www.avxcorp.com
Central Semiconductor	631-435-1110	631-435-1824	www.centralsemi.com
Panasonic	714-373-7366	714-737-7323	www.panasonic.com
Sumida USA	847-545-6700	847-545-6720	www.sumida.com
TDK	847-803-6100	847-390-4405	www.component.tdk.com

**Note:** Please indicate that you are using the MAX1945 when contacting these component suppliers.

# MAX1945 Evaluation Kit

**Table 1. Jumpers JU1, JU2 Functions**

IC CTL1 PIN JUMPER JU1 (SHUNT)	IC CTL2 PIN JUMPER JU2 (SHUNT)	MAX1945 EV KIT OUTPUT VOLTAGE	MAX1945 STATUS
Connected to V <sub>CC</sub> (none)	Connected to V <sub>CC</sub> (none)	1.8V (nominal output)	MAX1945 is enabled
Connected to GND (installed)	Connected to V <sub>CC</sub> (none)	1.87V (+4% voltage margining)	MAX1945 is enabled
Connected to V <sub>CC</sub> (none)	Connected to GND (installed)	1.73V (-4% voltage margining)	MAX1945 is enabled
Connected to GND (installed)	Connected to GND (installed)	0V (output is OFF)	MAX1945 is in shutdown mode

**Table 2. Jumper JU3 Functions**

SHUNT LOCATION	SYNC PIN	MAX1945 FREQUENCY
None	Connected to V <sub>CC</sub>	1MHz switching frequency
Installed	Connected to GND	500kHz switching frequency
None; external clock source	Connected to SYNC PC board pad	External TTL/CMOS digital clock provides synchronization

TTL/CMOS digital clock. JU3 selects the switching frequency or synchronization source for the MAX1945R. Table 2 lists the jumper options.

### **Clock Selection (SYNC Input)**

The MAX1945 EV kit's circuit can be synchronized to an external TTL/CMOS digital clock using the SYNC and GND PC board pads. The external clock provides a square wave with the following signal specifications:

- Output voltage:  
Logic high = 1.6V (min) to 5V (max)  
Logic low = 0V (min) to 0.4V (max)
- Output frequency: 400kHz to 1.2MHz
- Duty cycle: 10% to 90%

JU3 must be reconfigured for the external clock (see Table 2).

### **Dual Power-Supply Design (SYNCOUT)**

The MAX1945 EV kit features a PC board pad for the SYNCOUT signal connection to evaluate a dual postregulated power-supply design. Utilizing the SYNCOUT signal as a TTL/CMOS digital clock to drive a second MAX1945 EV kit enables the second MAX1945R to switch 180 degrees out-of-phase relative to the first EV kit. The second MAX1945 EV kit's SYNC input is driven by the SYNCOUT of the first EV kit. JU3 must be properly configured on both EV kits. The first MAX1945 EV kit should be configured for 500kHz switching frequency. The second EV kit must be configured for an external TTL/CMOS digital clock (see Table 2). Use the GND pad near the SYNC and SYNCOUT pads on both EV kits for the clock GND.

### **Output Voltage Selection**

The MAX1945 EV kit provides a jumper to select the output voltage that the EV kit can provide. JU4 configures the EV kit for outputs of 1.8V, 2.5V, or an output voltage determined by the R1 and R2 resistor-divider. Table 3 lists the jumper options.

### **Evaluating Other Output Voltages**

The MAX1945 EV kit step-down switching regulator output is set to 1.8V by an internal feedback resistor pair, resistor R1, and JU4. To generate output voltages other than 1.8V (0.8V to 0.85x VIN), select different external voltage-divider resistors R1 and R2. JU4 must also be reconfigured. See Table 3 for configuring the EV kit for other output voltages. Refer to the *Setting the Output Voltages* section in the MAX1945 data sheet for instructions on selecting feedback resistors R1 and R2, and compensation components R3 and C5.

# MAX1945 Evaluation Kit

**Table 3. Jumper JU4 Functions**

SHUNT LOCATION	FBSEL PIN	FB PIN	MAX1945 EV KIT OUTPUT
1, 2	Connected to VCC	Connected to VOUT	2.5V, resistor R1 = 0Ω
2, 3	Connected to GND	Connected to VOUT	1.8V, resistor R1 = 0Ω
None*	Floating*	VOUT regulates when FB pin is 0.8V*	Output voltage set by resistors R1, R2*

\*See the Evaluating Other Output Voltages section.

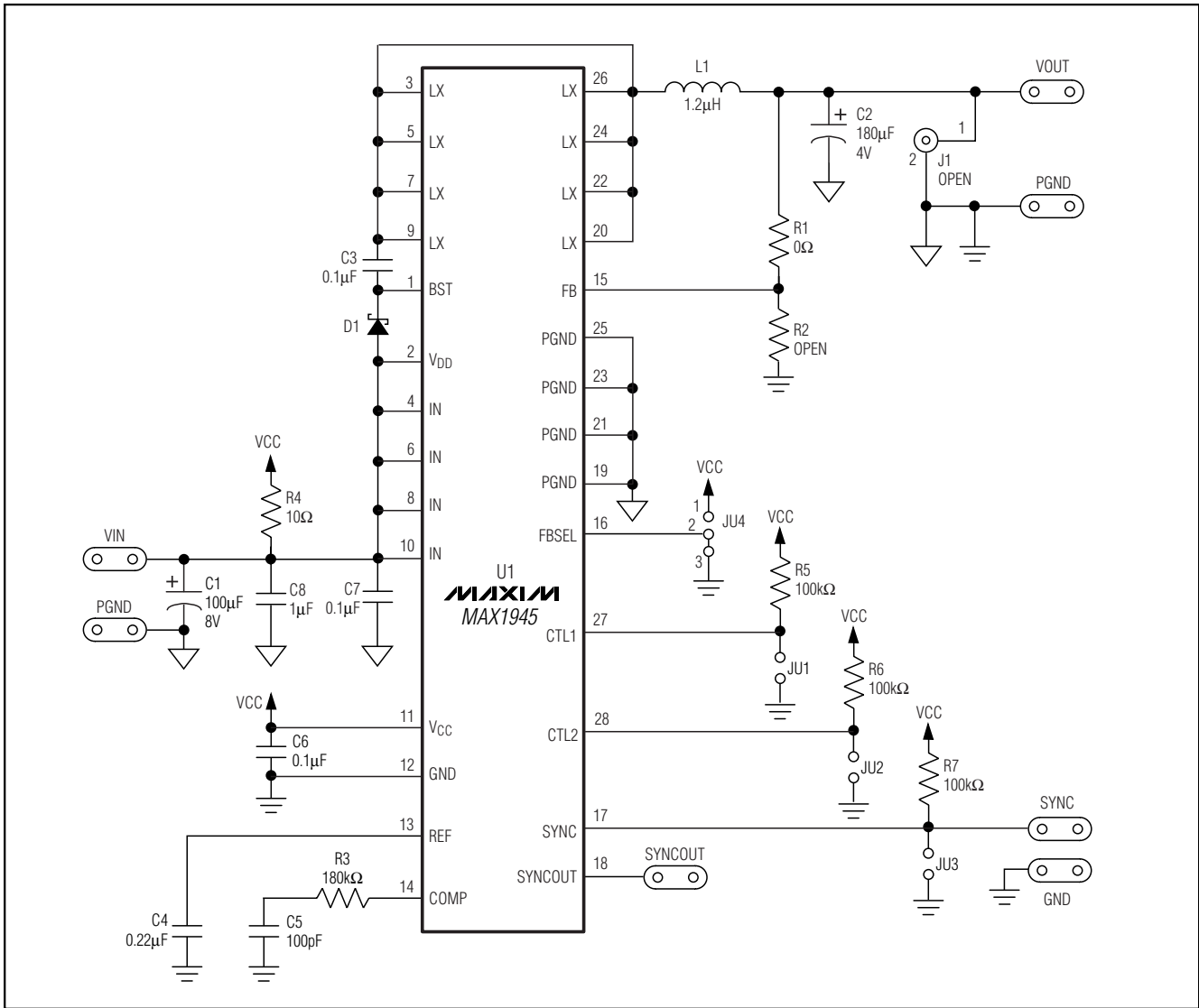

Figure 1. MAX1945 EV Kit Schematic

# MAX1945 Evaluation Kit

Evaluates: MAX1945

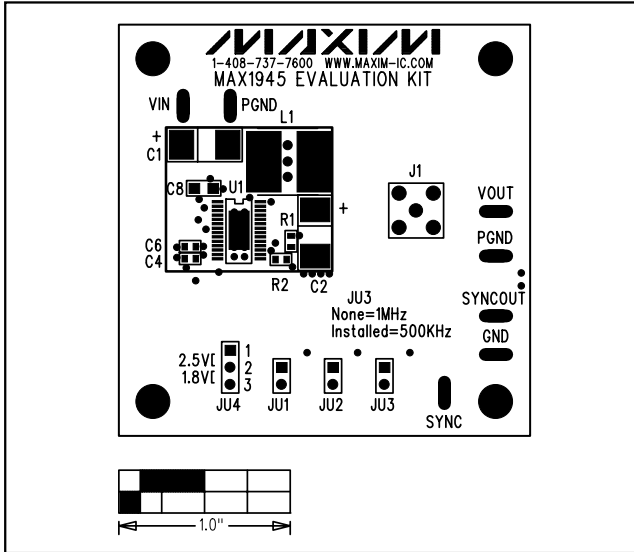

Figure 2. MAX1945 EV Kit Component Placement Guide—Solder Side

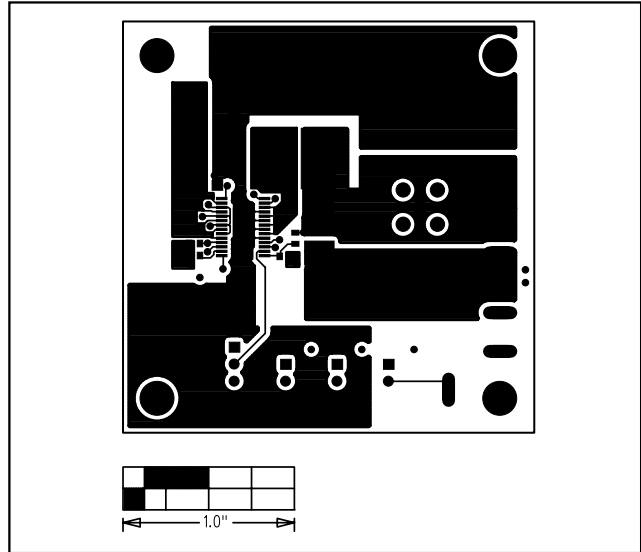

Figure 3. MAX1945 EV Kit Component Placement Guide—Component Side

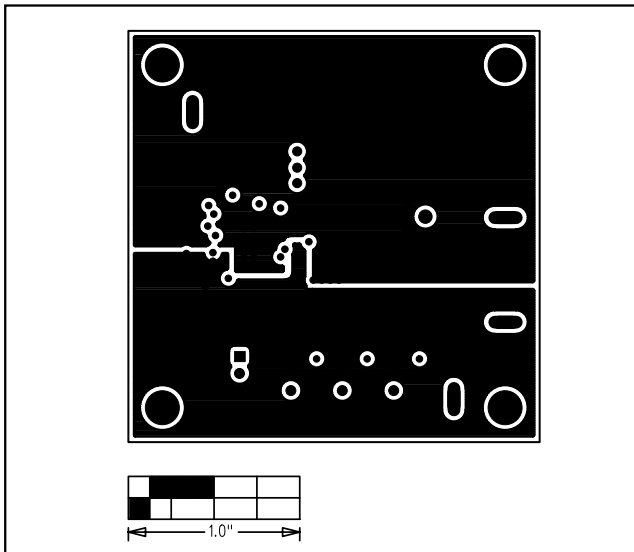

Figure 4. MAX1945 EV Kit PC Board Layout—Component Side

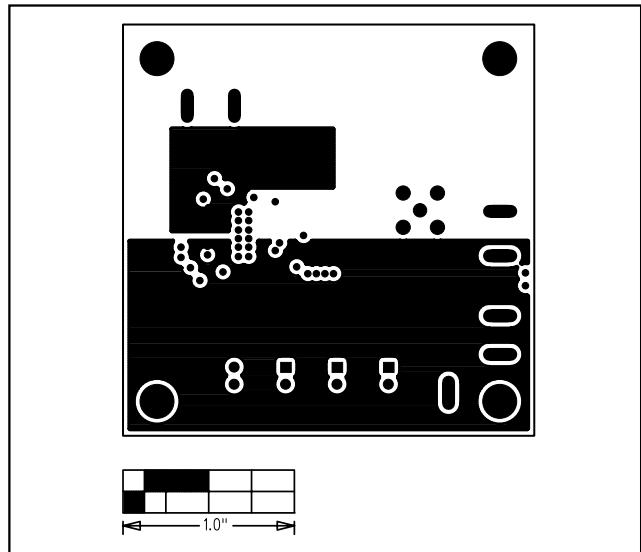

Figure 5. MAX1945 EV Kit PC Board Layout—Inner Layer, Ground Plane

# MAX1945 Evaluation Kit

Evaluates: MAX1945

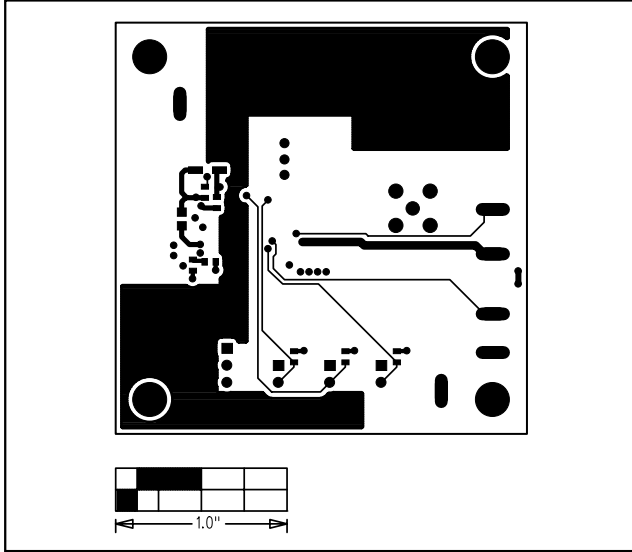

Figure 6. MAX1945 EV Kit PC Board Layout—Inner Layer, Power Plane

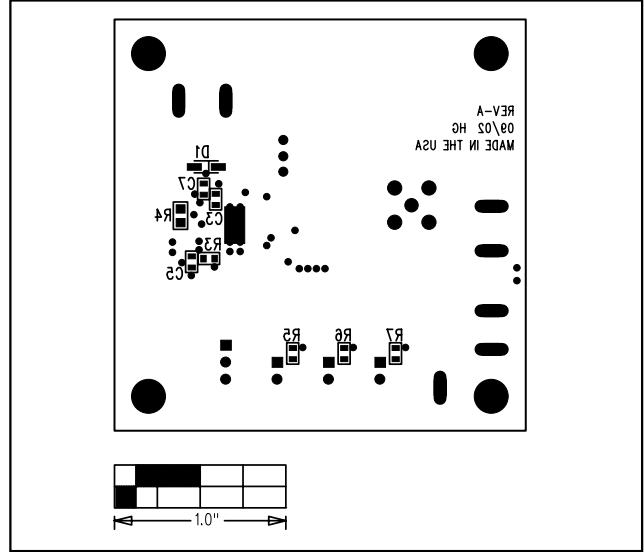

Figure 7. MAX1945 EV Kit PC Board Layout—Solder Side

Maxim cannot assume responsibility for use of any circuitry other than circuitry entirely embodied in a Maxim product. No circuit patent licenses are implied. Maxim reserves the right to change the circuitry and specifications without notice at any time.

6 Maxim Integrated Products, 120 San Gabriel Drive, Sunnyvale, CA 94086 408-737-7600