

## TV SOUND CHANNEL WITH DC CONTROLS

- INTERNAL VCR INPUT/OUTPUT SWITCHING
- 4W OUTPUT POWER INTO 16Ω
- NO SCREENING REQUIRED
- HIGH SENSITIVITY
- EXCELLENT AM REJECTION
- LOW DISTORTION
- DC TONE/VOLUME CONTROLS
- THERMAL PROTECTION

High output, high sensitivity, excellent AM rejection and low distortion make the device suitable for use in TVs of almost every type. Further, no screening is necessary because the device is free of radiation problems.

### DESCRIPTION

The TDA4190 is a complete TV sound channel with DC tone and volume controls plus an internally switched VCR input/output. Mounted in a Powerdip 16 + 2 + 2 package, the device delivers an output power of 4 W into 16Ω ( $d = 10\%$ ,  $V_s = 24V$ ) or 1.5W into 8Ω ( $d = 10\%$ ,  $V_s = 12V$ ). Included in the TDA4190 are : IF amplifier limiter, active low-pass filter, AF preamplifier and power amplifier, turn-off muting, VCR switch, mute circuit and thermal protection.

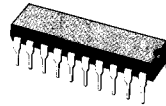

**DIP-20**  
(plastic package)

**ORDER CODE : TDA4190A**

### CONNECTION DIAGRAM

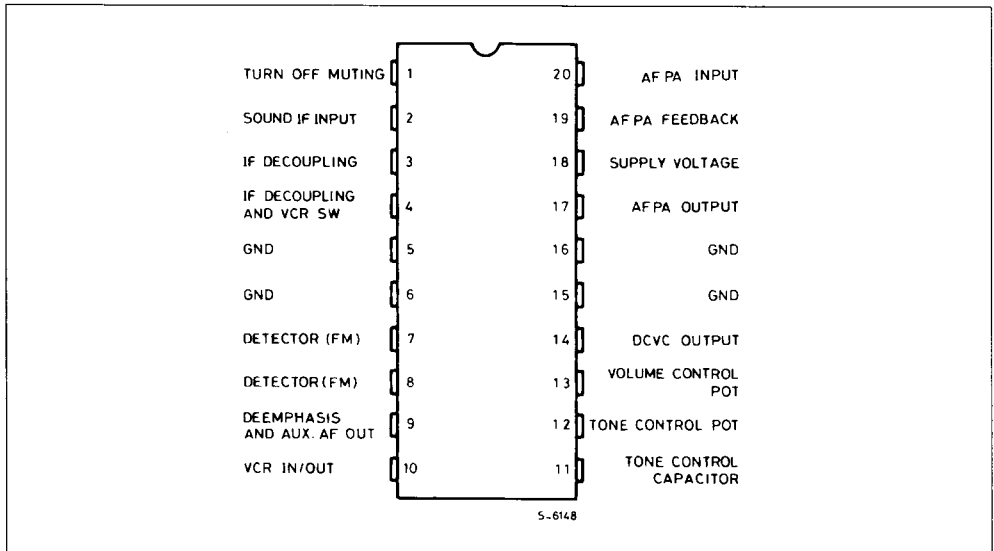

**BLOCK DIAGRAM**

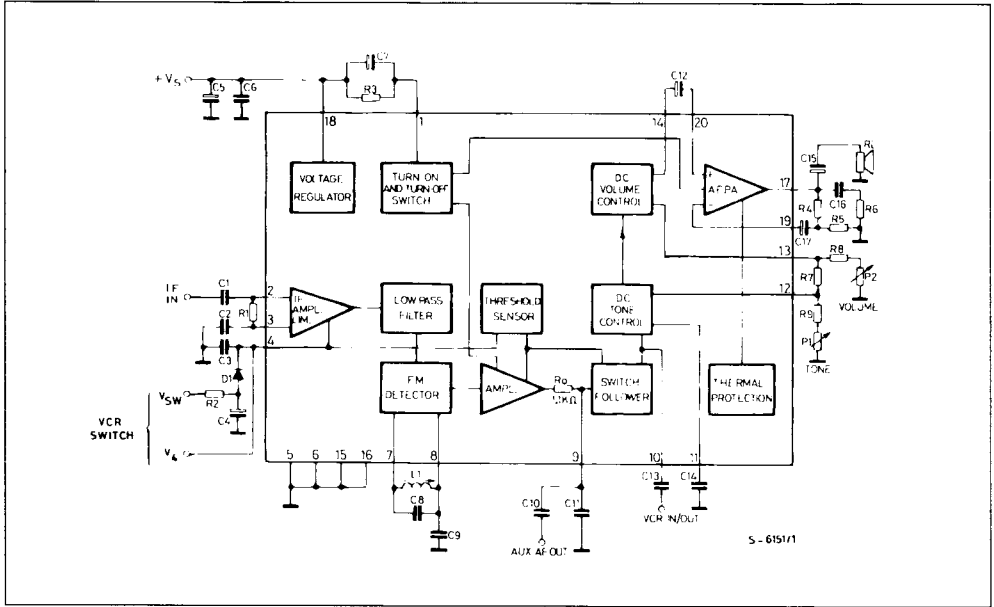

**ABSOLUTE MAXIMUM RATINGS**

Symbol	Parameter	Value	Unit
$V_S$	Supply Voltage (pin 18)	28	V
$V_1$	Voltage at pin 1	$\pm V_S$	
$V_i$	Input Voltage (pin 2)	1	$V_{pp}$
$I_o$	Output Peak Current (repetitive)	1.5	A
$I_o$	Output Peak Current (non repetitive)	2	A
$I_4$	Current (pin 4)	10	mA
$P_{tot}$	Power Dissipation : at $T_{pins} = 90\text{ }^\circ\text{C}$ at $T_{amb} = 70\text{ }^\circ\text{C}$	4.3 1	W W
$T_{stg}, T_j$	Storage and Junction Temperature	- 40 to 150	$^\circ\text{C}$

**THERMAL DATA**

$R_{th\ j-pins}$	Thermal Resistance Junction-pins	Max	14	$^\circ\text{C/W}$
$R_{th\ j-amb}$	Thermal Resistance Junction-ambient	Max	80	$^\circ\text{C/W}^*$

(\*) Obtained with GND pins soldered to printed circuit with minimized copper area.

**ELECTRICAL CHARACTERISTICS** (refer to the test circuit,  $V_s = 24V$ ,  $V_{sw} = 2V$  or no  $V_4$ ,  $\Delta f = \pm 25KHz$ ,  $R_L = 16\Omega$ ,  $V_i = 1mV$ ,  $P_1 = 12K\Omega$ ,  $f_o = 4.5MHz$ ,  $f_m = 400Hz$ ,  $T_{amb} = 25^\circ C$ , unless otherwise specified)

## DC CHARACTERISTICS

Symbol	Parameter	Test Conditions	Min.	Typ.	Max.	Unit
$V_s$	Supply Voltage (pin 18)	$P_2 = 12 K\Omega$	10.8		27	V
$V_o$	Quiescent Output Voltage (pin 18)		11	12	13	
$V_1$	Pin 1 DC Voltage	$P_2 = 12 K\Omega$		$R_1 = 270 K\Omega$	5.3	V
$V_4$	Pin 4 DC Voltage	$P_2 = 12 K\Omega$			3.2	V
$I_d$	Quiescent Drain Current				32	mA

## IF AMPLIFIER AND DETECTOR

$V_{i (threshold)}$	Input Limiting Voltage at Pin 2 (-3 dB)	$V_o = 4 V_{rms}$		50	100	$\mu V$
$V_9$	Recovered Audio Voltage (pin 9)	$\Delta f = \pm 7.5 KHz$ $P_2 = 12 K\Omega$	140	200	280	mV
AMR	Amplitude Modulation Rejection (*)	$m = 0.3$ ; $V_i = 1 mV$ ; $V_o = 4 V_{rms}$		60		dB
$R_i$	Input Resistance (pin 2)	$\Delta f = 0$ $P_2 = 12 K\Omega$		30		$K\Omega$
$C_i$	Input Capacitance (pin 2)			6		pF
$R_9$	Deemphasis Resistance	$C_1 = 68$ to $888 nF$	0.75	1.1	1.5	$K\Omega$

## DC VOLUME CONTROL

$K_v$	Volume Attenuation (resistance control)	$P_2 = 0 K\Omega$ $P_2 = 4.3 K\Omega$ $P_2 = 12 K\Omega$	20	0 26 88	32	dB dB dB
$V_c$	Control Voltage	$K = 0$ dB $K = 26$ dB $K = 88$ dB		0 1.3 2.6		V V V
$\frac{\Delta K_v}{\Delta T_{pins}}$	Volume Attenuation Thermal Drift (resistance control)	$T_{pins} 25$ to $85^\circ C$ $P_2 = 4.3 K\Omega$		-0.05		$\frac{dB}{^\circ C}$

## DC TONE CONTROL

$K_T$	Tone Cut	$V_{sw} = 8 V$ or $V_4 = 2 V$ $V_{10} = 200 mV$ $P_1 = 12 K\Omega$ to $100 \Omega$ $f = 10 KHz$		14		dB
-------	----------	--	--	----	--	----

## ELECTRICAL CHARACTERISTICS (continued)

## AUDIO FREQUENCY AMPLIFIER

Symbol	Parameter	Test Conditions		Min.	Typ.	Max.	Unit
$P_o$	Output Power (d = 10 %)	$V_s = 24\text{ V}$ $V_s = 12\text{ V}$	$R_L = 16\ \Omega$ $R_L = 8\ \Omega$	3.5	4.1 1.5		W W
B	Frequency Response of Audio Amplifier (-3 dB)	$P_o = 1\text{ W}$ $V_{sw} = 8\text{ V}$ or $V_{10} = 200\text{ mV}$	$R_L = 16\ \Omega$ $V_4 = 2\text{ V}$ $V_o = 4\text{ Vrms @}$ 400 Hz	15	50		KHz
SVR	Supply Voltage Rejection	$P_2 = 12\text{ K}\Omega$ $\Delta f = 0$	$f_{ripple} = 120\text{ Hz}$		26		dB

## V.C.R.

Symbol	Parameter	Test Conditions	Floating				
$V_4$	Input Switching Voltage for Recording for Playback				2	V	
$V_{sw}$	Input Switching voltage for Recording for Playback			8	2	V	
$V_{10}$	Input Voltage (playback)	$V_4 = 2\text{ V}$ or $V_o = 4\text{ Vrms}$	$V_{sw} = 8\text{ V}$ $P_2 = 0$	50	70	100	mV
$V_{10}$	Output Voltage (recording)	$P_2 = 12\text{ K}\Omega$	$\Delta f = \pm 7.5\text{ KHz}$	140	200	280	mV
$R_{10}$	Input Resistance (playback)	$V_4 = 2\text{ V}$ or	$V_{sw} = 8\text{ V}$	10			K $\Omega$
$R_{10}$	Output Resistance (recording)	$\Delta f = \pm 7.5\text{ KHz}$ , no $V_4$ or $V_{sw} = 2\text{ V}$				100	$\Omega$
d	Total harmonic Distortion of Pin 10 Output Signal	$\Delta f = \pm 7.5\text{ KHz}$	$V_i = 1\text{ mV}$		0.5		%
d	Total Harmonic distortion of 20 dB Over Load $V_{10}$	$V_4 = 2\text{ V}$ $V_{10} = 1\text{ Vrms}$	$V_{sw} = 8\text{ V}$ $V_o = 4\text{ Vrms}$		0.5	3	%
SVR	Supply Voltage Rejection at Output Pin 10	$\Delta f = 0$ $f_{ripple} = 120\text{ Hz}$ $P_2 = 12\text{ K}\Omega$			66		dB
$\frac{S+N}{N}$	Signal and Noise Ratio at Output Pin 10	$\Delta f = \pm 25\text{ KHz}$ $V_i \geq 1\text{ mV}$			70		dB

## OVERALL CIRCUIT

$\frac{S+N}{N}$	Signal to Noise Ratio (*)	$V_i \geq 1\text{ mV}$ $\Delta f = 0$	$V_o = 4\text{ Vrms}$		70		dB
d	Distortion (*)	$P_o = 50\text{ mW}$ $V_s = 24\text{ V}$ $V_s = 12\text{ V}$	$\Delta f = \pm 7.5\text{ Hz}$ $R_L = 16\ \Omega$ $R_L = 8\ \Omega$		0.5 0.5		% %
M	Muting (*)	$V_o = 4\text{ Vrms @}$ no $V_1 : V_1 = 0$		100			dB
$\Delta f$		$P_2 = 0$	$V_o = 4\text{ Vrms}$		3	6	KHz

\* Test bandwidth = 20 KHz.

TEST CIRCUIT

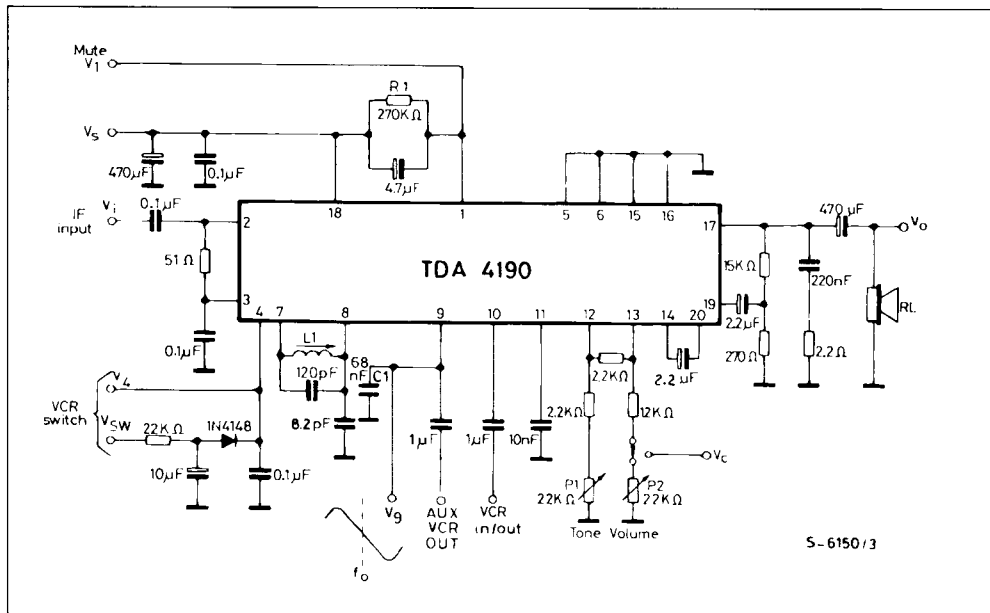

S-6150/3

TEST CONDITIONS (unless otherwise specified)

- $V_s = 24V$  ;                       $V_{sw} = 2V$  or no  $V_4$  ;                       $R_L = \infty$  ;
- $V_{in} = 1mV$  ;                       $Q_o = 60$  ;                       $f_o = 4.5MHz$  ;
- $P_1 = 12KW$  ;                       $f_m = 400Hz$  ;                       $\Delta f = \pm 25KHz$ .

Figure 1 : Relative Audio Output Voltage and Output Noise vs. Input Signal.

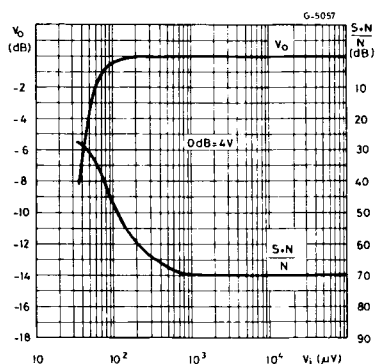
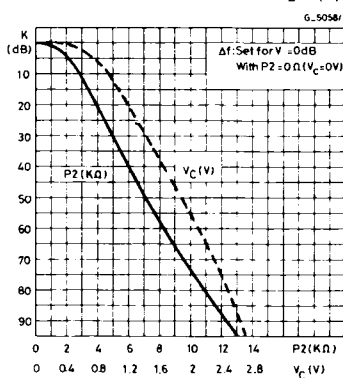
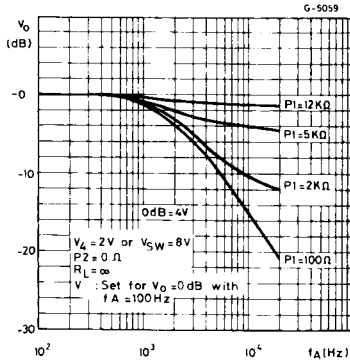

Figure 2 : Output Voltage Alternance vs. DC Volume Control Resistance (a) or Vs. DC Volume Control Voltage (b).



**Figure 3 :** DC Tone Control Cut of the High Audio Frequencies for some Values of Resistance Adjusted by P1.



**Figure 4 :** Amplitude Modulation Rejection vs. Input Signal.

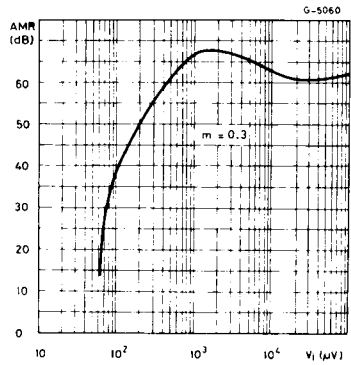

**Figure 5 :**  $\Delta$  AMR vs. Tuning Frequency Change

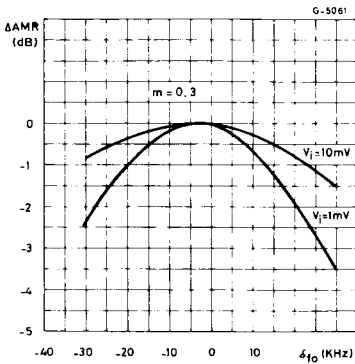

**Figure 6 :** Recovered Audio Voltage vs. Unloaded Q-factor of the Detector Coil.

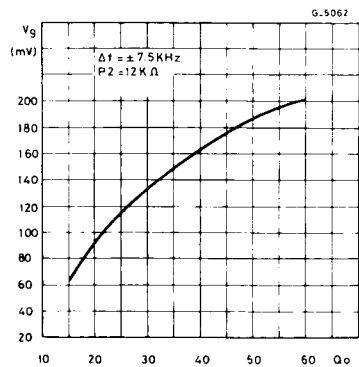

**Figure 7 :** Distortion vs. Unloaded Q-factor of the Detector Coil.

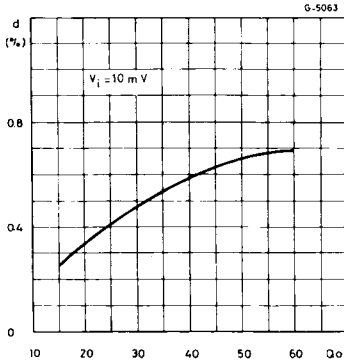

**Figure 8 :** Distortion vs. Frequency Variation.

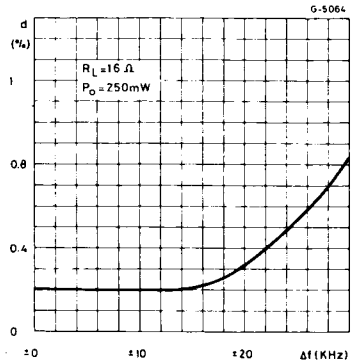

**Figure 9 :** Distortion vs. Tuning Frequency Change.

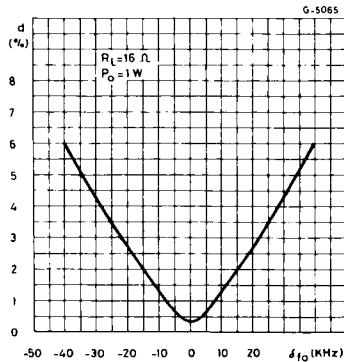

**Figure 10 :** Distortion vs. Output Power.

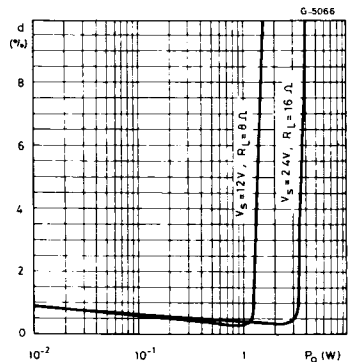

**Figure 11 :** Audio Amplifier Frequency Response.

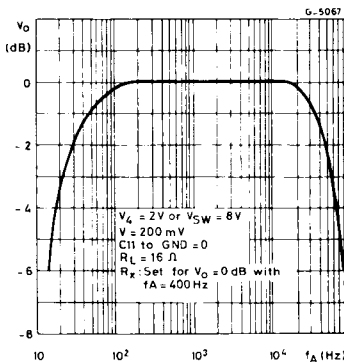

**Figure 12 :** Output Power vs. Supply Voltage.

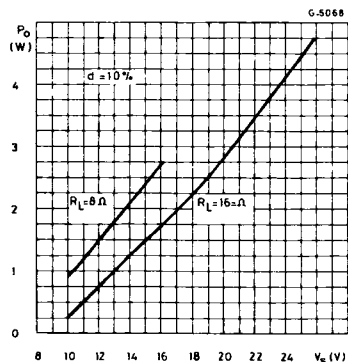

**Figure 13 :** Power Dissipation vs. Supply Voltage (sine Wave operation).

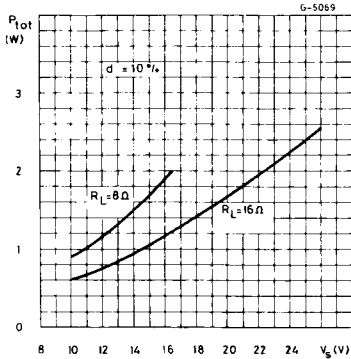

**Figure 14 :** Power Dissipation and Efficiency vs. Output Power.

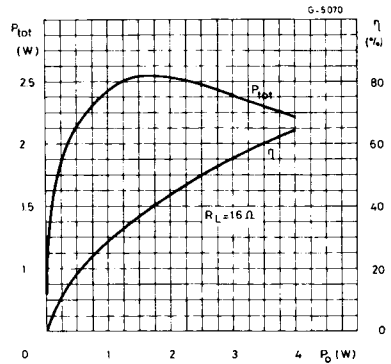

**Figure 15 :** Quiescent Drain and Quiescent Output Voltage vs. Supply Voltage.

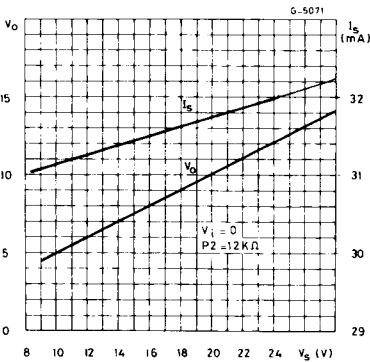

**APPLICATION INFORMATION** (refer to the block diagram)

**IF AMPLIFIER-LIMITER**

It is made by six differential stages of 15dB gain each so that an open loop gain of 90 dB is obtained. While a unity DC gain is provided, the AC closed loop gain is internally fixed at 70dB that allows a typical input sensitivity of  $50\mu V$ .

The differential output signal is single ended by a 20dB gain amplifier that through a buffer stage, feeds the detector system.

Internal diodes protect the inputs against overloads.

- Pin 2 is the IF non-inverting input
- Pin 3 is decoupled by a capacitor to open the AC loop

- Pin 4 grounded by a capacitor, allows a typical sensitivity of  $50\mu V$ . (see VCR facility too).

**LOW-PASS FILTER, FM DETECTOR AND AMPLIFIER**

The IF signal is detected by converting the frequency modulation into amplitude modulation and then detecting it.

Since the available modulated signal is a square wave, a 40dB/decade low-pass filter cuts its harmonics so that a sine wave can feed the two-resonances external network L1, C8 and C9.



This network defines the working frequency value, the amplitude of the recovered audio signal and its distortion at the highest frequency deviations.

The two resonances  $f_1$  (series resonance) and  $f_2$  (parallel resonance) can be computed respectively by :

$$X_{C9} = \frac{X_{L1} \cdot X_{C8}}{X_{L1} + X_{C8}} \quad \text{and} \quad X_{L1} = X_{C8}$$

The ratio of these frequencies defines the peak-to-peak separation of the "S" curve :

$$\frac{f_2}{f_1} = \sqrt{1 + \frac{C_9}{C_8}}$$

A differential peak detector detects the audio frequency signal that amplified, reaches the deemphasis network R0 ; C11.

The AF amplifier can be muted (see turn-on and turn-off switch and VCR facility).

- Pin 7 is the output of the low-pass filter and one input of the differential peak detector
- Pin 8 is the other input of the differential peak detector

- Pin 9 is used to provide the required deemphasis time constant by grounding it with C11. At this pin, the internal impedance of which is typically of 1.1 K $\Omega$ , is available the recovered audio signal as auxiliary output.

#### VCR FACILITY

The deemphathized AF signal reaches the switch follower block can provide to change the impedance of its output depending on the VCR function required.

The switch follower is driven by the threshold sensor block. This one switches both the amplifier and the switch follower by sensing the voltage at pin 4.

When no voltage is forced at pin 4 the function of pin 10 is of VCR output with low impedance ; when the voltage at pin 4 is lower or higher than its quiescent value, the amplifier is muted and the impedance of pin 10 is switched to a high value for a proper VCR input operation.

Since pin 4 reaches also the inverting input of the IF amplifier-limiter, this one can be switched off two for best insulation of the pin 10 with the TV signal path.

So, the VCR facility followed this truth table :

Mode	V <sub>sw</sub>	or V <sub>4</sub>	Function of Pin 10	Impedance of Pin 10
Recording Playback	$\leq 2 \text{ V}$ $\geq 8 \text{ V}$	No One $\leq 2 \text{ V}$	Output Input	$\leq 100 \Omega$ $\geq 10 \text{ K}\Omega$

The output signal available when operating during recording is not dependent from both the volume and tone controls while, during playback, the input signal can be regulated by P1 and P2.

Pin 10, as input, can accept until 1 VRMS of overload.

- Pin 4 is the VCR switch driver
- Pin 10 is the VCR input/output pin.

#### DC TONE CONTROL

The same signal available or applied to pin 10, after a voltage to current converter, reaches, the DC Tone Control block. It operates, inside the 10 KHz bandwidth, by cutting the high audio frequencies with a variable slope of an RC network, by means of P1

The maximum slope of the RC network is of 20 dB per decade and its pole is defined by :

$$X_{C11} = 6.8\text{K}\Omega, \text{ typically.}$$

Pin 11 – At this pin is tied the tone capacitor

Pin 12 – is the DC Tone Control input.

#### DC VOLUME CONTROL

After tone control regulation, the AF current signal reaches the DC volume control block, that controls its intensity. The normal control, for which the block has been designed for a narrow spread, is produced by P2 ; however, without P2, a voltage control can be operated by forcing a voltage at pin 13 through R8.

- Pin 12, already seen as a DCTC input, is the reference voltage for the DCVC. Because of this, a small interface between tone and volume regulation can be expected.
- Pin 13 is the DC volume control input.
- Pin 14 after a current to voltage converter, the audio frequency signal comes out a this pin.

#### AUDIO FREQUENCY POWER AMPLIFIER AND THERMAL PROTECTION

Through C12 the signal reaches the amplifier non-inverting input. The closed loop gain is defined by

the feedback at pin 19 (inverting input) or by the ratio :

$$G_v = 20 \text{ Log } \frac{R5 + R4}{R5} \text{ (dB)}$$

The amplifier, thermally protected, can supply 4 W of power into a 16 Ω load with 24 V of supply voltage. The power output stage is a class B type.

- Pin 20 is the non-inverting input
- Pin 19 is the inverting input
- Pin 17 is the output of the AFPA.

**TURN-ON AND TURN-OFF SWITCH**

This block has been mainly designed to avoid, turning on the TV set, that transients, produced by the vision output, can reach the speaker.

Moreover this block, together an optimized rise time and full time of the supply voltage  $V_s$ , can avoid any pop generally produced during the turn-on and the turn-off transients.

Turning on, pin 1 follows the supply voltage  $V_s$  by means of C7 ; a threshold is reached and the muting of the AFPA output (pin 17) is suddenly produced.

When  $V_s$  reaches it stop, C7 charges itself through the input impedance of pin 1 and the muting is removed with a time constant depending on the C7 value.

Turning off, the  $V_s$  trend, in series to the voltage  $V_s - V_1$  and which C7 is charged, drives pin 1 at a low level threshold and a sudden muting is produced again.

Since the turn-off can be operated with high output power, if the muting operates when the current through the inductance of the speaker is different from zero, a flyback is generated and then a small pop can be produced.

The flyback is clipped by integrated diodes.

The threshold that produce the muting have been chosen in the way that 1 Vpp of ripple on the supply voltage does not produce any switching.

By shorting pin 1 to ground through a 10 KΩ resistor the muting can be obtained.

- Pin 1 is the turn-on and turn-off muting input.

**SUPPLY**

An integrated voltage regulator with different output levels, supplies all the blocks operating with small signal.

- Pin 18 is the main supply of the device.
- Pin 5 ; pin 6 ; pin 15 and pin 16 are the ground of the supply. These pins are used to drain out from the device the heat produced by the dissipated power.

**Figure 16 : Application Circuit.**

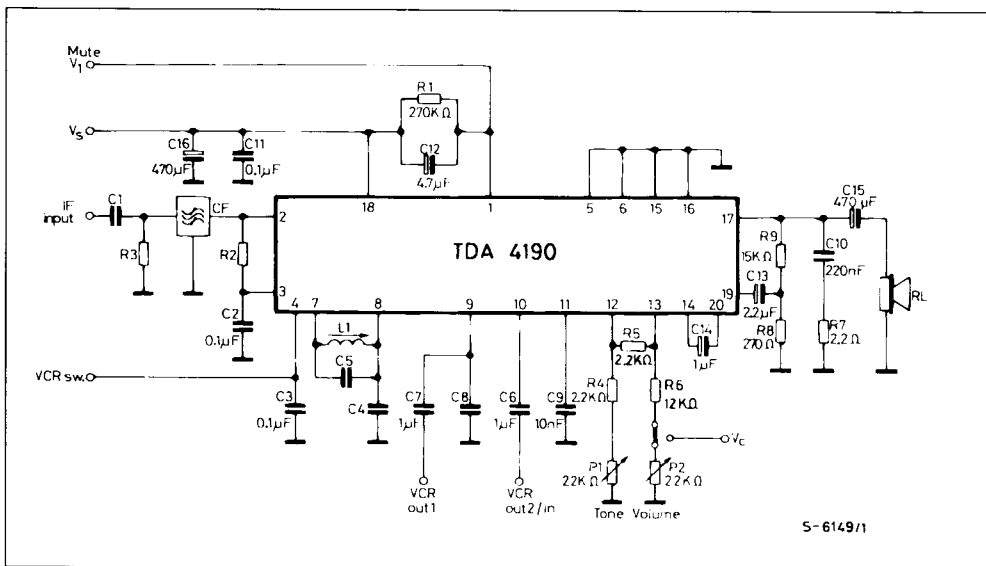

Components	Units	Appl. 4.5 MHz	Appl. 5.5 MHz	Appl. 6 MHz
L1	$\mu\text{H}$	10 $Q_0 = 60$	12 $Q_0 = 80$	10 $Q_0 = 70$
C5	pF	120	68	68
C4	pF	9	8.2	6.8
C8	nF	68	47	47
C.F.	—	Murata SFE 4.5 MA	Murata SFE 5.5 MB	Murata SFE 6.0 MB
C1	pF	22	18	18
R2	$\Omega$	1000	560	470
R3	$\Omega$	1000	560	470

Figure 17 : PC Board and Components Layout of the Circuit of Fig. 16 (1 : 1 scale).

