

HEXFET® Power MOSFET

- Isolated Package
- High Voltage Isolation= 2.5KVRMS ②
- Sink to Lead Creepage Dist.= 4.8mm
- P-Channel
- Dynamic dv/dt Rating
- Low Thermal Resistance

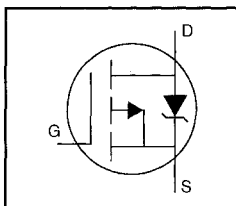

$$V_{DSS} = -200V$$

$$R_{DS(on)} = 1.5\Omega$$

$$I_D = -3.0A$$

Description

The HEXFET technology is the key to International Rectifier's advanced line of power MOSFET transistors. The efficient geometry and unique processing of the HEXFET design achieve very low on-state resistance combined with high transconductance and extreme device ruggedness.

The TO-220 Fullpak eliminates the need for additional insulating hardware in commercial-industrial applications. The moulding compound used provides a high isolation capability and a low thermal resistance between the tab and external heatsink. This isolation is equivalent to using a 100 micron mica barrier with standard TO-220 product. The Fullpak is mounted to a heatsink using a single clip or by a single screw fixing.

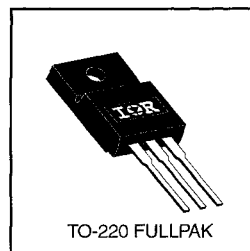
 DATA
SHEETS

Absolute Maximum Ratings

	Parameter	Max.	Units
$I_D @ T_C = 25^\circ C$	Continuous Drain Current, $V_{GS} @ -10 V$	-3.0	A
$I_D @ T_C = 100^\circ C$	Continuous Drain Current, $V_{GS} @ -10 V$	-1.9	
I_{DM}	Pulsed Drain Current ①	-12	
$P_D @ T_C = 25^\circ C$	Power Dissipation	30	W
	Linear Derating Factor	0.24	W/°C
V_{GS}	Gate-to-Source Voltage	± 20	V
E_{AS}	Single Pulse Avalanche Energy ②	80	mJ
I_{AR}	Avalanche Current ①	-3.0	A
E_{AR}	Repetitive Avalanche Energy ①	3.0	mJ
dv/dt	Peak Diode Recovery dv/dt ③	-5.0	V/ns
T_J	Operating Junction and Storage Temperature Range	-55 to +150	°C
T_{STG}			
	Mounting Torque, 6-32 or M3 screw	10 lbf•in (1.1 N•m)	

Thermal Resistance

	Parameter	Min.	Typ.	Max.	Units
$R_{\theta JC}$	Junction-to-Case	—	—	4.1	°C/W
$R_{\theta JA}$	Junction-to-Ambient	—	—	65	

Electrical Characteristics @ $T_J = 25^\circ\text{C}$ (unless otherwise specified)

	Parameter	Min.	Typ.	Max.	Units	Test Conditions
$V_{(BR)DSS}$	Drain-to-Source Breakdown Voltage	-200	—	—	V	$V_{GS}=0V, I_D=-250\mu A$
$\Delta V_{(BR)DSS}/\Delta T_J$	Breakdown Voltage Temp. Coefficient	—	-0.22	—	$V/^\circ\text{C}$	Reference to 25°C , $I_D=-1mA$
$R_{DS(on)}$	Static Drain-to-Source On-Resistance	—	—	1.5	Ω	$V_{GS}=-10V, I_D=-1.8A$ ④
$V_{GS(th)}$	Gate Threshold Voltage	-2.0	—	-4.0	V	$V_{DS}=V_{GS}, I_D=-250\mu A$
g_{fs}	Forward Transconductance	1.3	—	—	S	$V_{DS}=-50V, I_D=-1.8A$ ④
I_{DSS}	Drain-to-Source Leakage Current	—	—	-100	μA	$V_{DS}=-200V, V_{GS}=0V$
		—	—	-500		$V_{DS}=-160V, V_{GS}=0V, T_J=125^\circ\text{C}$
I_{GSS}	Gate-to-Source Forward Leakage	—	—	-100	nA	$V_{GS}=-20V$
	Gate-to-Source Reverse Leakage	—	—	100		$V_{GS}=20V$
Q_g	Total Gate Charge	—	—	15	nC	$I_D=-2.1A$
Q_{gs}	Gate-to-Source Charge	—	—	3.2		$V_{DS}=-160V$
Q_{gd}	Gate-to-Drain ("Miller") Charge	—	—	8.4		$V_{GS}=-10V$ See Fig. 6 and 13 ④
$t_{d(on)}$	Turn-On Delay Time	—	8.8	—	ns	$V_{DD}=-100V$
t_r	Rise Time	—	27	—		$I_D=-3.9A$
$t_{d(off)}$	Turn-Off Delay Time	—	7.3	—		$R_G=18\Omega$
t_f	Fall Time	—	19	—		$R_D=24\Omega$ See Figure 10 ④
L_D	Internal Drain Inductance	—	4.5	—	nH	Between lead, 6 mm (0.25in.) from package and center of die contact
L_S	Internal Source Inductance	—	7.5	—		
C_{iss}	Input Capacitance	—	340	—	pF	$V_{GS}=0V$
C_{oss}	Output Capacitance	—	110	—		$V_{DS}=-15V$
C_{rss}	Reverse Transfer Capacitance	—	33	—		$f=1.0MHz$ See Figure 5
C	Drain to Sink Capacitance	—	12	—	pF	$f=1.0MHz$



Source-Drain Ratings and Characteristics

	Parameter	Min.	Typ.	Max.	Units	Test Conditions
I_S	Continuous Source Current (Body Diode)	—	—	-3.0	A	MOSFET symbol showing the integral reverse p-n junction diode. 
I_{SM}	Pulsed Source Current (Body Diode) ①	—	—	-12		
V_{SD}	Diode Forward Voltage	—	—	-6.3	V	$T_J=25^\circ\text{C}, I_S=-3.0A, V_{GS}=0V$ ④
t_{rr}	Reverse Recovery Time	—	150	300	ns	$T_J=25^\circ\text{C}, I_F=-3.9A$
Q_{rr}	Reverse Recovery Charge	—	0.97	2.0	μC	$di/dt=100A/\mu s$ ④
t_{on}	Forward Turn-On Time	Intrinsic turn-on time is negligible (turn-on is dominated by L_S+L_D)				

Notes:

- ① Repetitive rating; pulse width limited by max. junction temperature (See Figure 11)
- ② $V_{DD}=-50V$, starting $T_J=25^\circ\text{C}$, $L=13mH$, $R_G=25\Omega$, $I_{AS}=-3.0A$ (See Figure 12)
- ③ $I_{SD}\leq 3.9A$, $di/dt\leq 95A/\mu s$, $V_{DD}\leq V_{(BR)DSS}$, $T_J\leq 150^\circ\text{C}$
- ④ Pulse width $\leq 300\mu s$; duty cycle $\leq 2\%$.
- ⑤ $t=60s$, $f=60Hz$

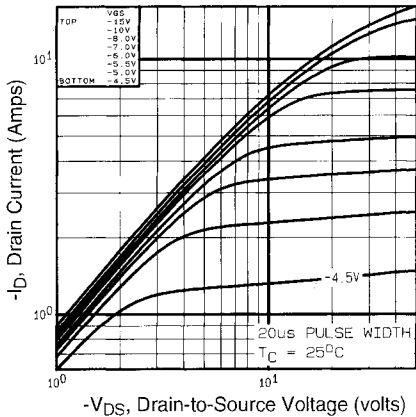

Fig 1. Typical Output Characteristics, $T_C=25^\circ\text{C}$

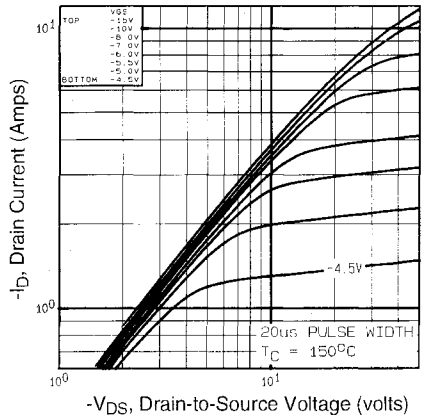

Fig 2. Typical Output Characteristics, $T_C=150^\circ\text{C}$

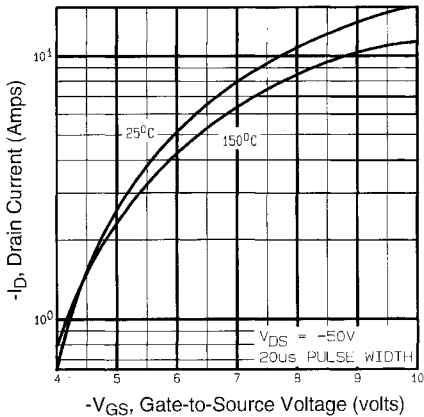

Fig 3. Typical Transfer Characteristics

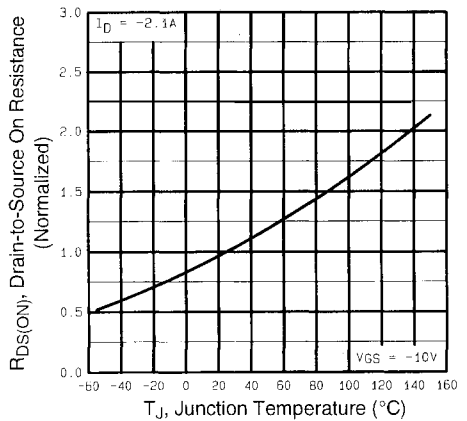

Fig 4. Normalized On-Resistance Vs. Temperature

DATA SHEETS

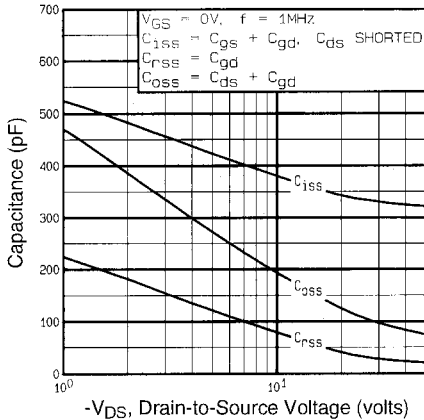

Fig 5. Typical Capacitance Vs. Drain-to-Source Voltage

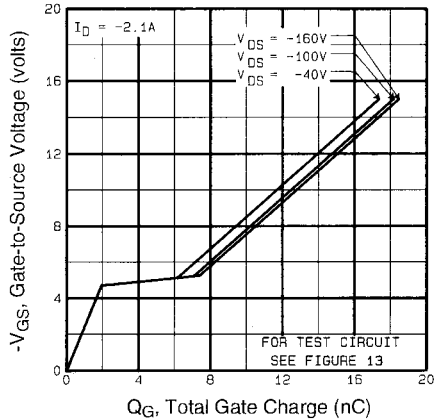

Fig 6. Typical Gate Charge Vs. Gate-to-Source Voltage

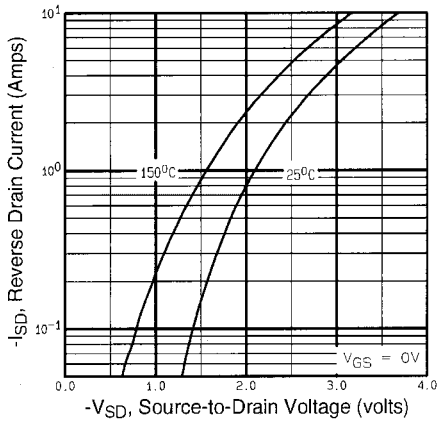

Fig 7. Typical Source-Drain Diode Forward Voltage

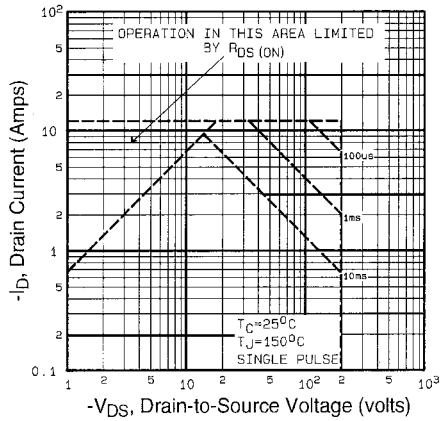

Fig 8. Maximum Safe Operating Area

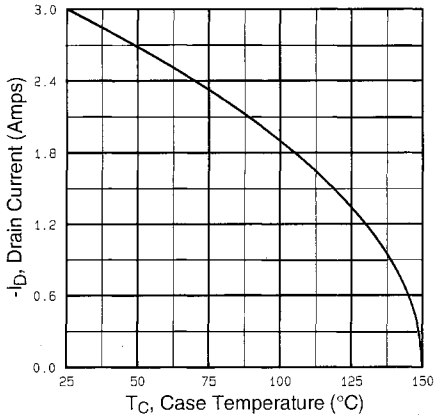

Fig 9. Maximum Drain Current Vs. Case Temperature

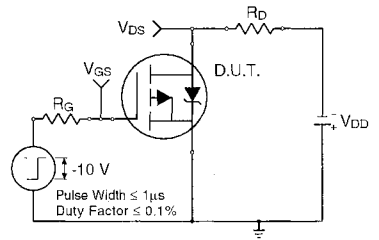

Fig 10a. Switching Time Test Circuit

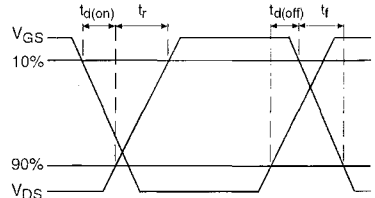

Fig 10b. Switching Time Waveforms

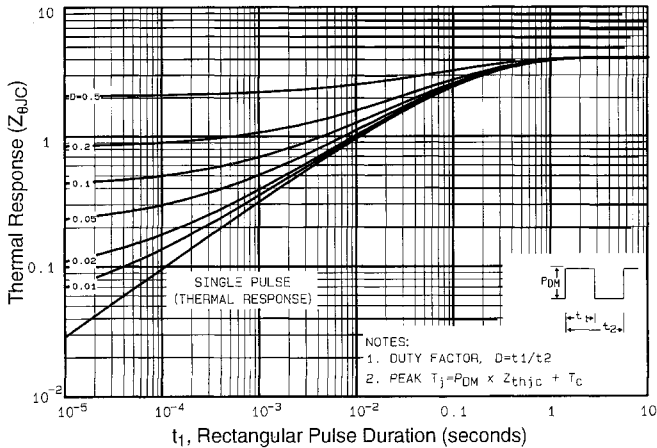

Fig 11. Maximum Effective Transient Thermal Impedance, Junction-to-Case

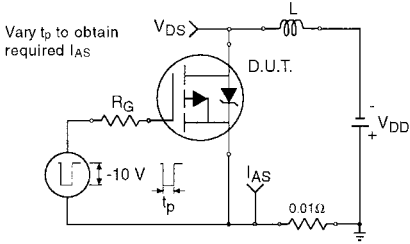

Fig 12a. Unclamped Inductive Test Circuit

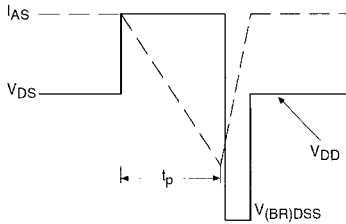

Fig 12b. Unclamped Inductive Waveforms

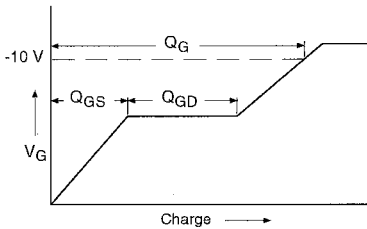

Fig 13a. Basic Gate Charge Waveform

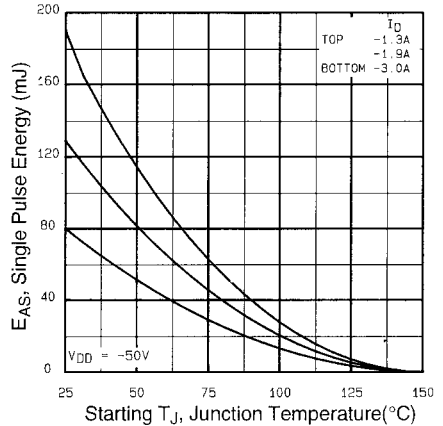

Fig 13c. Maximum Avalanche Energy Vs. Drain Current

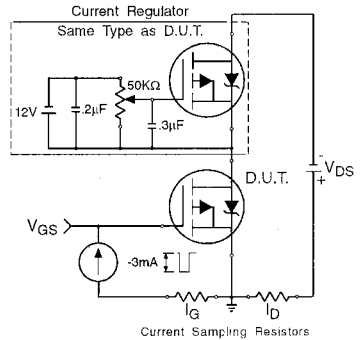

Fig 13b. Gate Charge Test Circuit

Appendix A: Figure 14, Peak Diode Recovery dv/dt Test Circuit – See page 1506

Appendix B: Package Outline Mechanical Drawing – See page 1510

Appendix C: Part Marking Information – See page 1517