

Advanced Product Information
February 2002 (1 of 6)

0.25 to 6.0 GHz High Dynamic Range Amplifier

Features

- ❑ 0.25 to 6.0 GHz Frequency Range
- ❑ 41 dBm Output IP3
- ❑ 1.7 dB Noise Figure
- ❑ 18.5 dB Gain
- ❑ 23 dBm P1dB
- ❑ LGA Package
- ❑ Single Power Supply
- ❑ Single Input Matching

Applications

- ❑ Wireless Local Loop Transmit and Receive
- ❑ UNII Transmit and Receive
- ❑ Dual Band 802.11 WLAN

Description

The CMM6004-AH is a high dynamic range amplifier designed for applications operating within the 0.25 to 6.0 GHz frequency range. It is an ideal solution for numerous transmit and receive functions in wireless local loop (WLL) and UNII applications where high linearity is required.

The amplifier has the flexibility of being optimized for a number of wireless applications. It is an ideal solution when used as a driver amplifier in applications including cellular and PCS (personal communications service) operating from 0.8 to 2.2 GHz; MMDS (multichannel multipoint distrib-

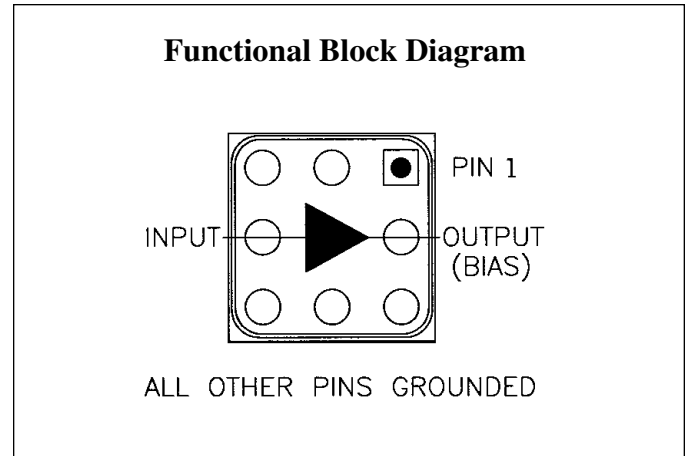

ution systems) operating from 2.2 to 2.7 GHz; WLAN (wireless LAN) operating at 2.4 GHz; WLL (wireless local loop) operating at 3.5 GHz; and HiperLAN (high performance LAN) and U-NII (unlicensed national information infrastructure) operating from 5.0 to 6.0 GHz.

The CMM6004-AH is packaged in a low-cost, space efficient, Land Grid Array (LGA) package which provides excellent electrical stability and low thermal resistance. All devices are 100% RF and DC tested. With single input matching the part simplifies design by keeping board space and cost to a minimum.

Electrical Characteristics

Unless otherwise specified, the following specifications are guaranteed at room temperature in a Celeritek test fixture.

Parameter	Condition	Min	Typ	Max	Units
Frequency Range		0.25		6.0	GHz
Gain	Externally matched	17.0	18.5	19.5	dB
Input Return Loss	Externally matched	-24	-10		dB
Output IP3		38	41	45	dBm
Noise Figure		1.5	1.7	1.85	dB
Output P1dB		22.5	23.0	23.5	dBm
Operating Current Range		175	185	200	mA
Supply Voltage			5.0		V

Notes:

1. T = 22°C, Vdd = 5.0, Frequency = 800 MHz, 50 Ohm system
2. Thermal resistance = 50°C/W.

Absolute Maximum Ratings

Parameter	Rating	Parameter	Rating	Parameter	Rating
Supply Voltage	+6.0 V	Storage Temperature	-40°C to +125°C	Operating Temperature	-40°C to +85°C
RF Input Power	+13 dBm	Junction Temperature	150°C		

Operation of this device above any of these parameters may cause damage.

Application Circuit (836 MHz)

Typical Performance (50 Ohm System)

Frequency	836 MHz
Gain	18 dB
Input Return Loss	-23 dB
Output Return Loss	-14 dB
OIP3	40 dBm
Noise Figure	1.75 dB
Bias	V _{ds} = 5V, I _d = 175 mA

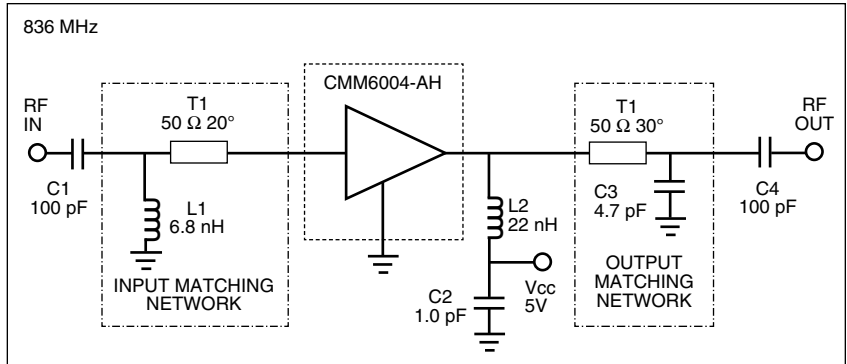

Circuit Board Parts List

Part Type	Reference Designator	Description
Inductor	L1	0603, 6.8 nH
Inductor	L2	0603, 22 nH
Capacitor	C1, C4	SMD 0805 NPO, 100 pF
Capacitor	C2	0603, 1 pF
Capacitor	C3	SMD 0805, 50V ±0.25 pF 4.7 pF

Typical Performance

IP3 measured with 2 tones at an output power of 5 dBm/tone separated by 10 MHz

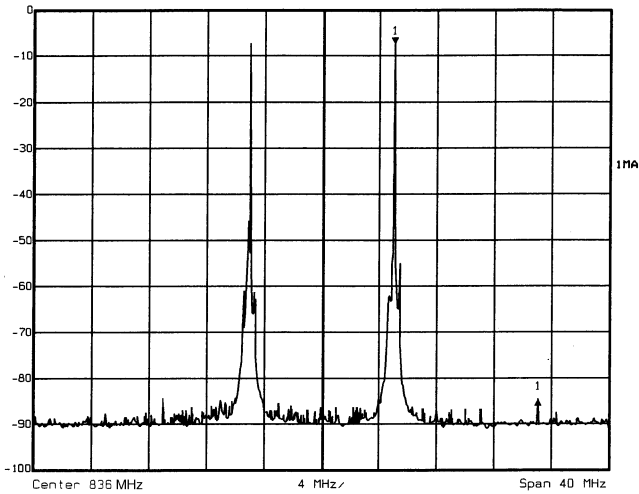

Gain, Input Return Loss and Output Return Loss vs Frequency

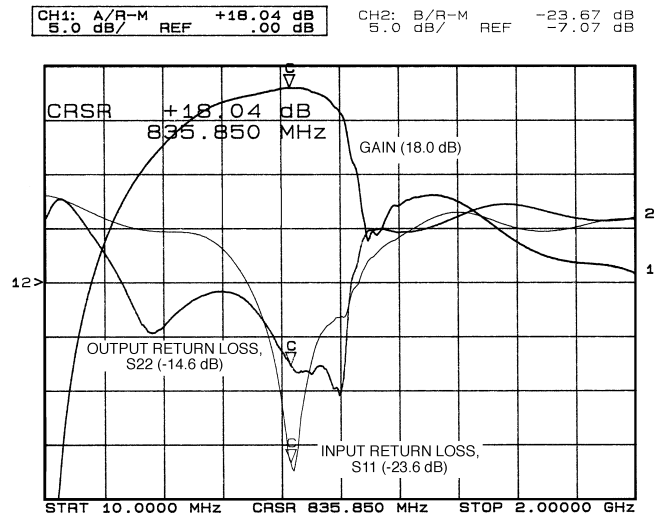

Application Circuit (2.1 GHz)

Typical Performance (50 Ohm System)

Frequency	2.1 GHz
Gain	15.8 dB
Input Return Loss	-14 dB
Output return Loss	-16.5 dB
OIP3	40 dBm
Noise Figure	2.95 dB
Bias	V _{ds} = 5V, I _d = 175 mA

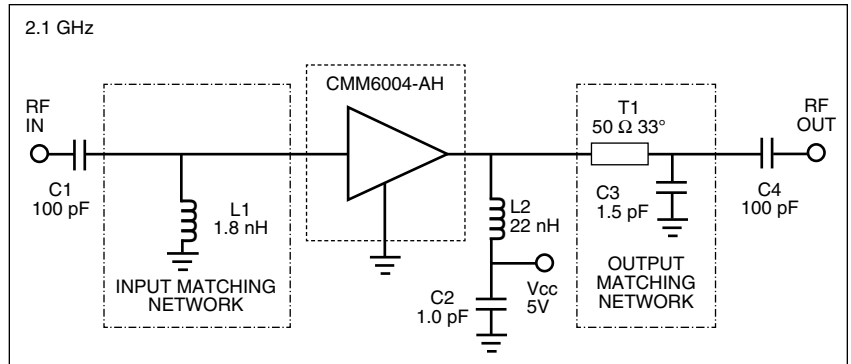

Circuit Board Parts List

Part Type	Reference Designator	Description
Inductor	L1	0603, ±0.3, 1.8 nH
Inductor	L2	0603, 22 nH
Capacitor	C1, C4	SMD 0805 NPO, 100 pF
Capacitor	C2	0603, 1 pF
Capacitor	C3	SMD 0603, 50V ±0.1 pF 1.5 pF

Typical Performance

IP3 measured with 2 tones at an output power of 5 dBm/tone separated by 10 MHz

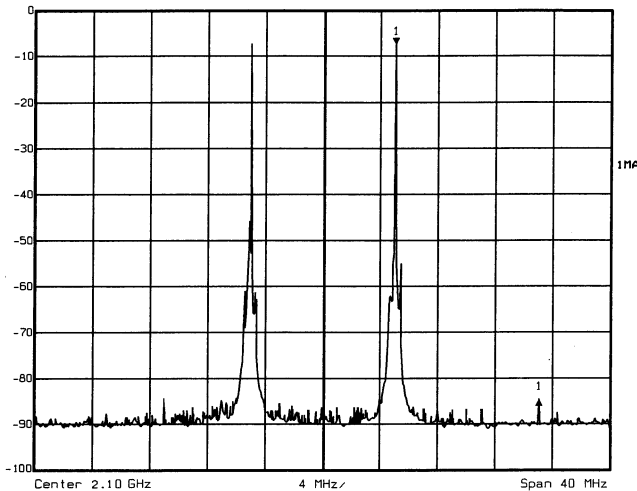

Gain, Input Return Loss and Output Return Loss vs Frequency

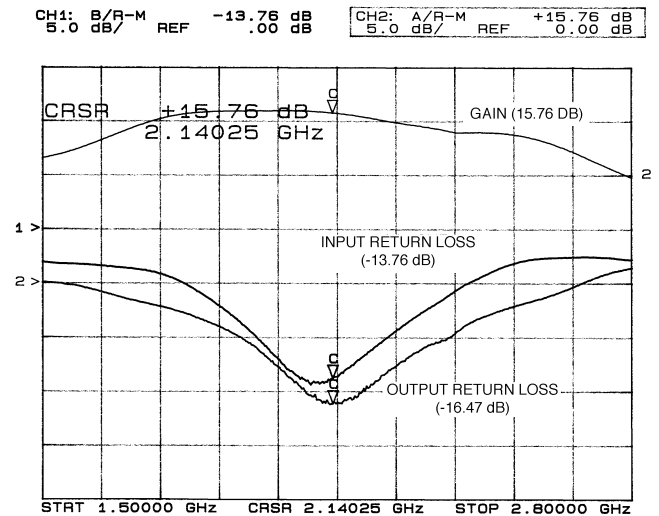

Application Circuit (5.8 GHz)

Typical Performance (50 Ohm System)

Frequency	5.8 GHz
Gain	10.5 dB
Input Return Loss	-11.5 dB
Output Return Loss	-17.2 dB
OIP3	40 dBm
Noise Figure	3.8 dB
Bias	V _{ds} = 5V, I _{ds} = 175 mA

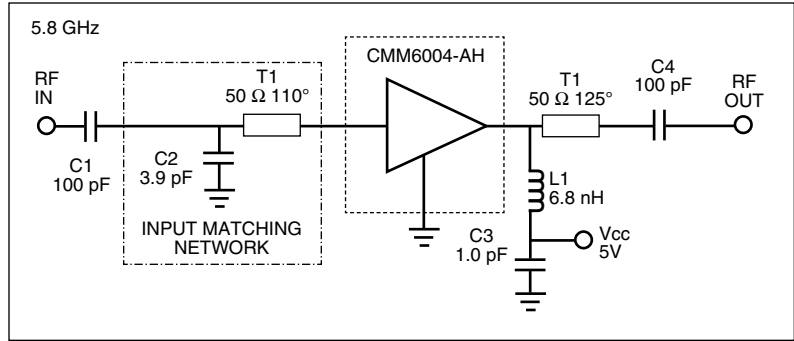

Circuit Board Parts List

Part Type	Reference Designator	Description
Inductor	L1	0603, 6.8 nH
Capacitor	C1, C4	SMD 0805 NPO, 100 pF
Capacitor	C2	SMD 0805, 3.9 pF
Capacitor	C3	0603, 1 pF

Typical Performance

Gain vs Temperature @ 5.8 GHz

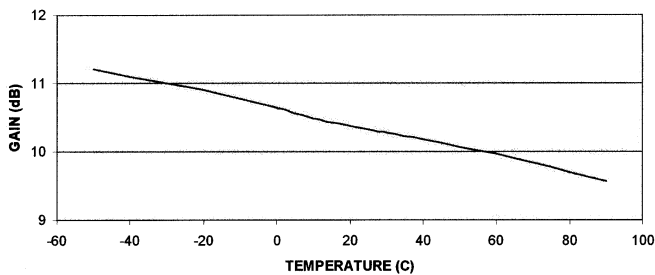

IP3 vs Temperature @ 5.8 GHz

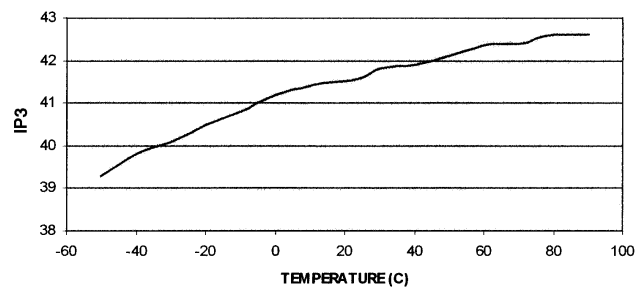

IP3 measured with 2 tones at an output power of 5 dBm/tone separated by 10 MHz

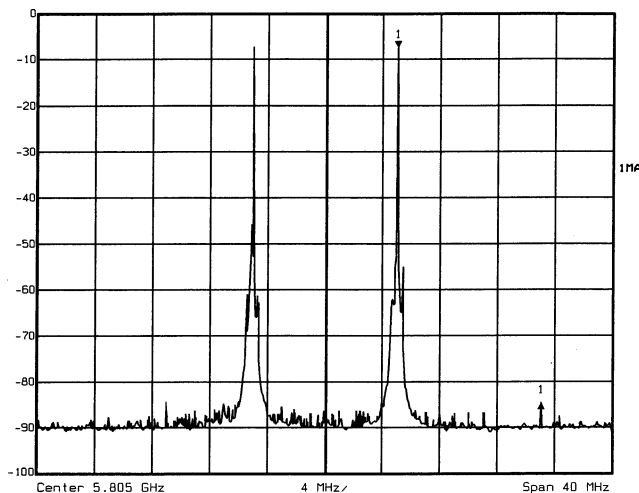

Gain, Input Return Loss and Output Return Loss vs Frequency

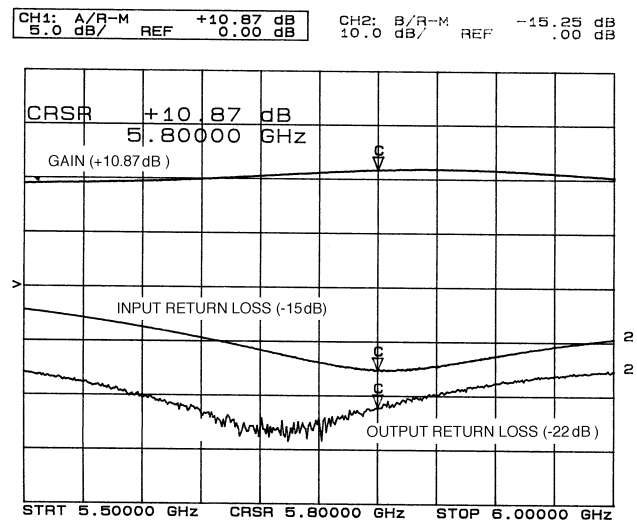

Physical Dimensions

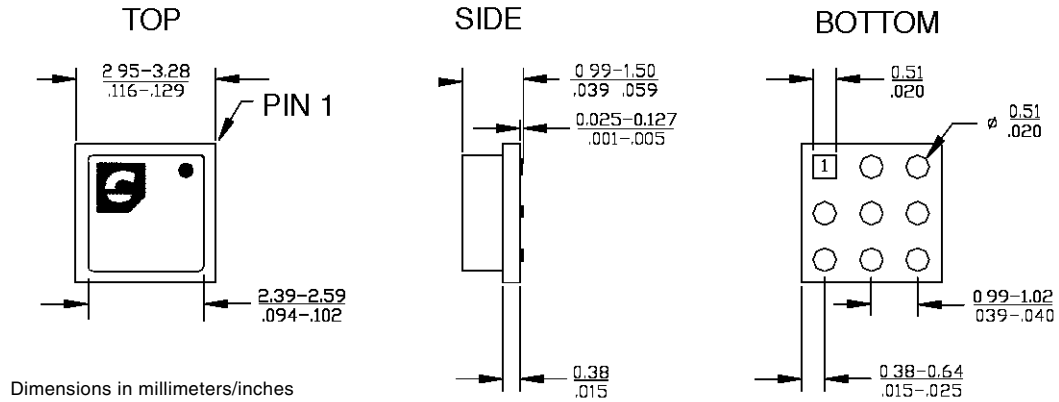

Mounting Recommendation

Board substrate:
 RO-4003
 Thickness = 31 mil

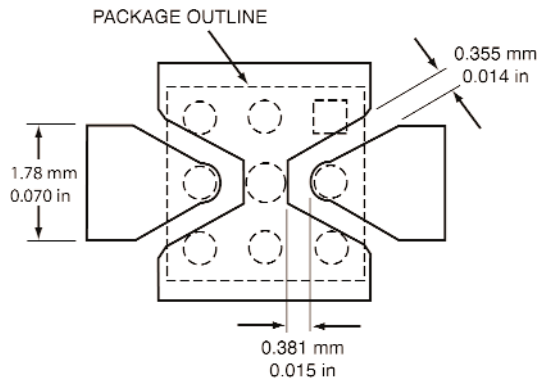

Ordering Information

The CMM6004-AH is available in a surface-mount LGA package and devices are available in tape and reel.

Part Number for Ordering

CMM6004-AH

PB-CMM6004-AH

Package

LGA surface-mount power package in tape and reel

Evaluation Board with SMA connectors for CMM6004-AH

Notes

Celeritek reserves the right to make changes without further notice to any products herein. Celeritek makes no warranty, representation or guarantee regarding the suitability of its products for any particular purpose, nor does Celeritek assume any liability arising out of the application or use of any product or circuit, and specifically disclaims any and all liability, including without limitation consequential or incidental damages. "Typical" parameters can and do vary in different applications. All operating parameters, including "Typicals" must be validated for each customer application by customer's technical experts. Celeritek does not convey any license under its patent rights nor the rights of others. Celeritek products are not designed, intended, or authorized for use as components in systems intended for surgical implant into the body, or other applications intended to support or sustain life, or for any other application in which the failure of the Celeritek product could create a situation where personal injury or death may occur. Should Buyer purchase or use Celeritek products for any such unintended or unauthorized application, Buyer shall indemnify and hold Celeritek and its officers, employees, subsidiaries, affiliates, and distributors harmless against all claims, costs, damages, and expenses, and reasonable attorney fees arising out of, directly or indirectly, any claim of personal injury or death associated with such unintended or unauthorized use, even if such claim alleges that Celeritek was negligent regarding the design or manufacture of the part. Celeritek is a registered trademark of Celeritek, Inc. Celeritek, Inc. is an Equal Opportunity/Affirmative Action Employer.