

## GaAs MMIC VOLTAGE VARIABLE ATTENUATOR 800-2000 MHz

FEBRUARY 2001

### Features

SINGLE POSITIVE VOLTAGE CONTROL: 0 to +3V

HIGH ATTENUATION RANGE: >50 dB @ 0.9 GHz

HIGH P1dB COMPRESSION POINT: +16 dBm

ULTRA SMALL PACKAGE: MSOP

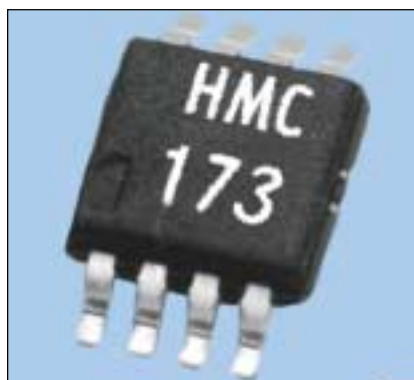

### General Description

The HMC173MS8 is a miniature absorptive voltage variable attenuator in an 8-lead MSOP package. The device operates with a positive supply voltage, and a positive control voltage. Unique features include a high dynamic attenuation range, and excellent power handling performance through all attenuation states. The HMC173MS8 is ideal for operation in wireless applications between 800 MHz and 1600 MHz. 1.7 to 2.0 GHz operation is possible, with a reduced maximum attenuation of 30 dB and increased VSWR. The HMC173MS8 can be used with an external driver circuit for improved linearity of attenuation.

### Guaranteed Performance $V_{dd} = +4.0$ Vdc, 50 Ohm System, -40 to +85°C

Parameter		Min	Typical	Max	Units
Insertion Loss (Min. Atten.) ( $V_{CTL} = 0.0$ Vdc)	800-1000 MHz		1.8	2.3	dB
	1000-1600 MHz		2.6	3.1	dB
	1600-2000 MHz		3.2	3.7	dB
Attenuation Range ( $V_{CTL} = 0$ to +3 V)	800-1000 MHz	45	52		dB
	1000-1600 MHz	27	32		dB
	1600-2000 MHz	25	30		dB
Flatness (Peak to Peak)	800-1000 MHz		± 0.15		dB
	1000-1600 MHz		± 0.25		dB
Return Loss ( $V_{CTL} = 0$ to +3 V)	800-1000 MHz	6	12		dB
	1000-1600 MHz	5	8		dB
	1600-2000 MHz	5	7		dB
Input Power for 0.1 dB Compression (825 MHz)	Min Atten.		19		dBm
	Atten.>2.0		9		dBm
Input Power for 1.0 dB Compression (825 MHz)	Min Atten.	21	25		dBm
	Atten.>2.0	10	16		dBm
Input Third Order Intercept 825 MHz, two tones @ +5.0 dBm	Min Atten.	30	37		dBm
	Atten.>2.0	15	21		dBm
Switching Characteristics $t_{RISE}, t_{FALL}$ (10/90% RF) $t_{ON}, t_{OFF}$ (50% CTL to 10/90% RF)	800-2000 MHz		1.0		µS
			1.2		µS



## HMC173MS8 VOLTAGE VARIABLE ATTENUATOR 800-2000 MHz

FEBRUARY 2001

**Attenuation vs. Control Voltage  
@900 and 1900 MHz**

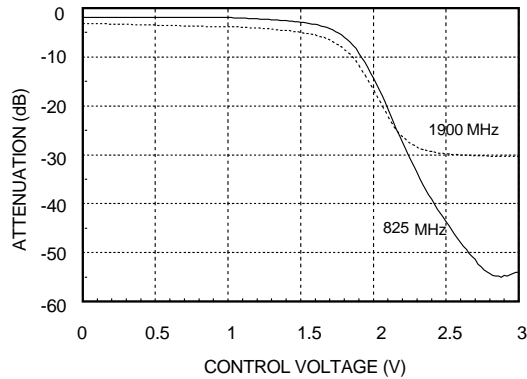

**Input IP3 vs. Control Voltage  
@825 MHz**

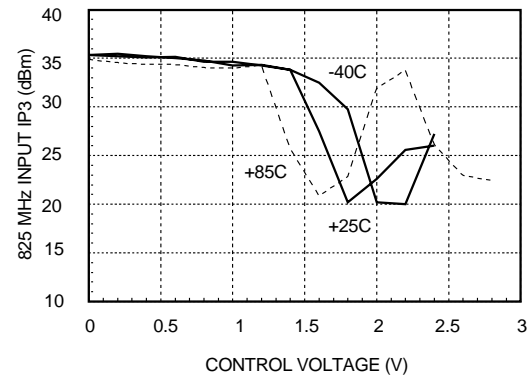

**Attenuation vs. Temperature  
Normalized to +25°C @825 MHz**

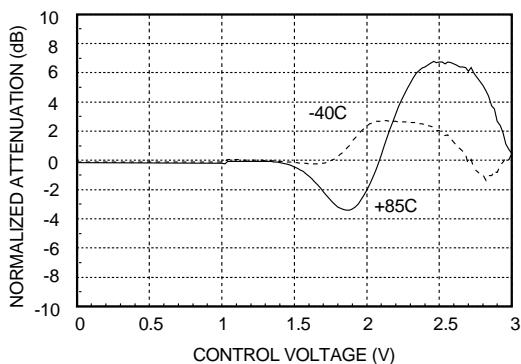

**Input P1dB Compression  
@825 MHz**

Input Power For 1 dB Compression Point						
Test Condition (825MHz)	V <sub>CTL</sub> (Vdc)	V <sub>dd</sub> (Vdc)	+25C	+85C	-40C	Units
Min. Attenuation	0.0	+4.0	26	24	25	dBm
Max. Attenuation	+3.0	+4.0	16.5	15	23	dBm
Worst Case P1dB @ Typical V <sub>CTL</sub>	+1.8	+4.0	16.5	15.5	14	dBm

**Broadband Attenuation and Insertion Loss**

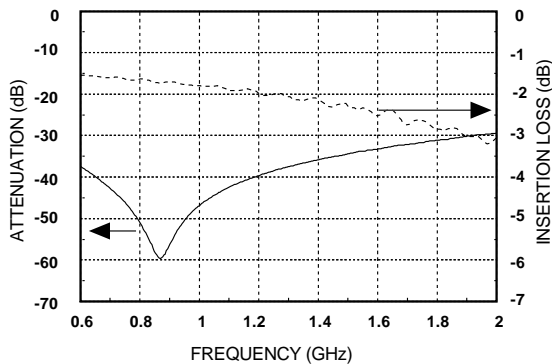

**Broadband Return Loss vs. Control Voltage**

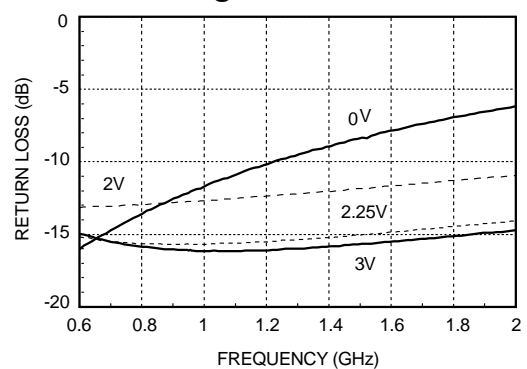

S - Parameter data is available On-Line at [www.hittite.com](http://www.hittite.com)



## HMC173MS8 VOLTAGE VARIABLE ATTENUATOR 800-2000 MHz

FEBRUARY 2001

### Typical Performance for 800-1000 MHz Applications

**Attenuation vs. Control Voltage  
825 MHz**

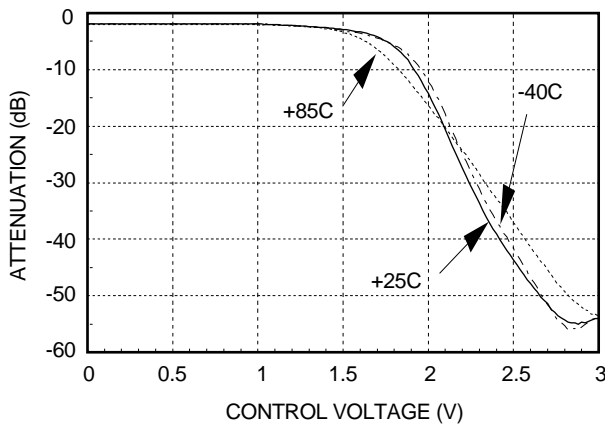

**Return Loss vs. Control Voltage  
825 MHz**

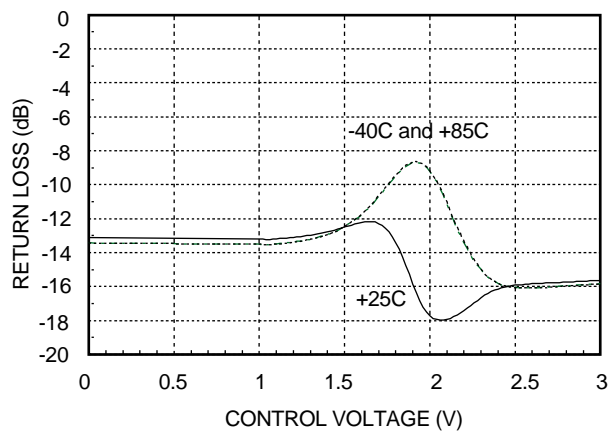

### Typical Performance for 1800-1900 MHz Applications

**Attenuation vs. Control Voltage  
1900 MHz**

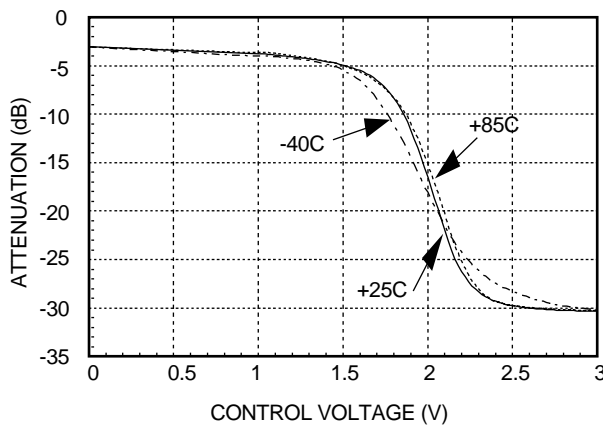

**Return Loss vs. Control Voltage  
1900 MHz**

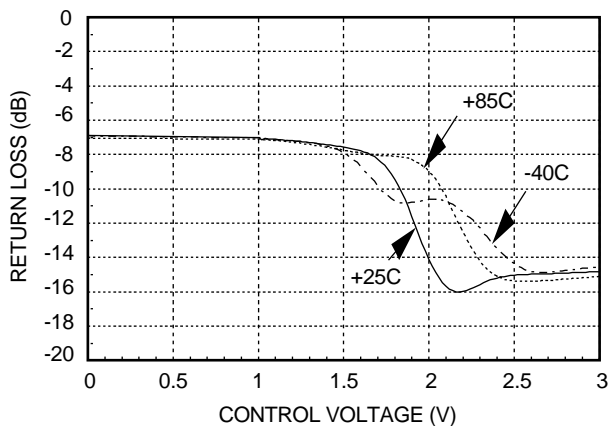

2  
SMT ATTENUATORS

## HMC173MS8 VOLTAGE VARIABLE ATTENUATOR 800-2000 MHz

FEBRUARY 2001

### Functional Diagram

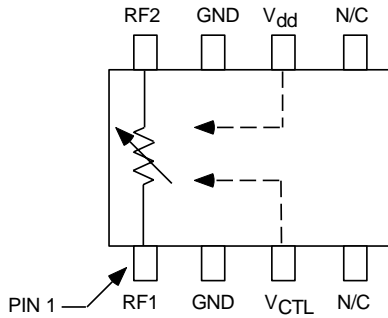

\*NOTE: DC blocking capacitors are required for each RF port. Capacitor value determines lowest frequency of operation.

### Control and Bias Voltages

$V_{CTL}$	0 to +3.0Vdc @ -100 $\mu$ A to +100 $\mu$ A
Vdd	+4.0Vdc +/- 0.1Vdc @ +100 $\mu$ A

### Absolute Maximum Ratings

$V_{CTL}$	-0.2 Vdc to Vdd	
Vdd	+8 Vdc	
Maximum Input Power Vdd = +4.0 Vdc	+29 dBm +21 dBm	Min Attenuation Att. > 2 dB
Storage Temperature	-65 to +150 deg. C	
Operating Temperature	-40 to +85 deg. C	

### Outline Drawing

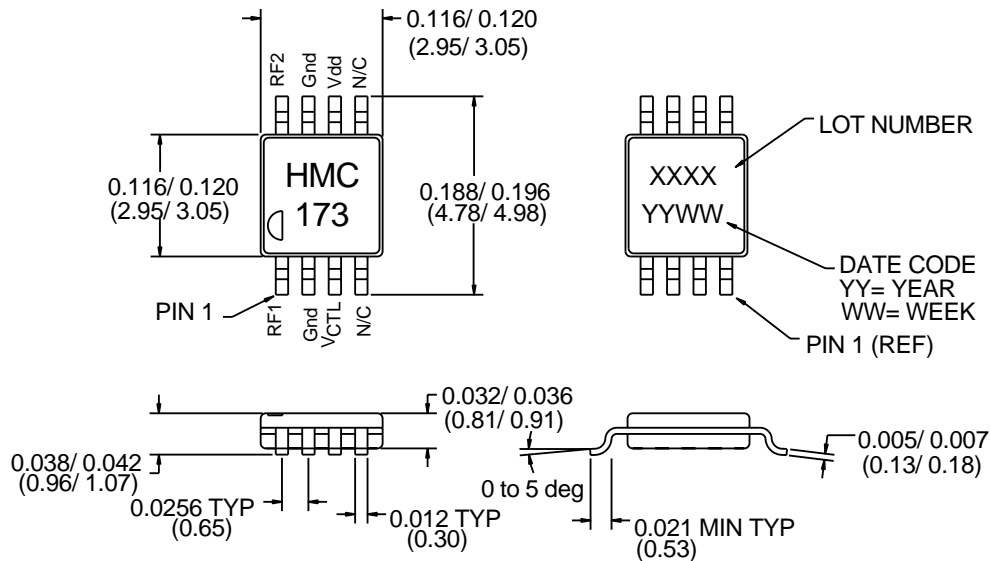

1. MATERIAL:
  - A) PACKAGE BODY - LOW STRESS INJECTION - MOLDED PLASTIC, SILICA & SILICONE IMPREGNATED.
  - B) LEADFRAME MATERIAL: COPPER ALLOY
2. PLATING: LEAD - TIN SOLDER PLATE
3. DIMENSIONS ARE IN INCHES (MILLIMETERS), UNLESS OTHERWISE SPECIFIED TOL. ARE  $\pm 0.005 (\pm 0.13)$
4. TAPE AND REEL SHIPMENT PACKAGING AVAILABLE, SEE PAGE 10 - 1

2  
ATTENUATORS  
SMT

## HMC173MS8 VOLTAGE VARIABLE ATTENUATOR 800-2000 MHz

FEBRUARY 2001

### Attenuation Linearizing Control Circuit For The HMC173MS8 Voltage Variable Attenuator

A driver circuit to improve the attenuation linearity of the HMC173MS8 can be implemented with a simple op-amp configuration. A *breakpoint* linearization circuit will scale the voltage supplied to the control line of the HMC173MS8, so that a more linear attenuation vs. control voltage slope can be achieved. A -5V and +5V supply is required.

Diode and resistor values which define the op-amp gain, and breakpoint were selected to optimize a measured production lot of attenuators at 825 MHz. R7 may be varied to optimize the performance of any given attenuator. If the input voltage to the linearizing circuit will not drop below 1.0V, then R9 and D2 may be omitted, and this will greatly reduce the overall power consumption of the driver circuit.

The linearizing circuit has been optimized for 825 MHz attenuation applications. A similar approach may be used at other frequencies by adjusting R1 - R9 resistor values.

### Required Parts List

Part	Description	Manufacturer
AD822	Op-Amp	Analog Devices
R1	10K ohms	Panasonic
R2	200K ohms	Panasonic
R3	7.5K ohms	Panasonic
R4	39K ohms	Panasonic
R5	220K ohms	Panasonic
R6	91K ohms	Panasonic
R7	910 ohms	Panasonic
R8	51 ohms	Panasonic
R9	100 ohms	Panasonic
D1, D2	LL4148 D-35	Digikey

### Schematic

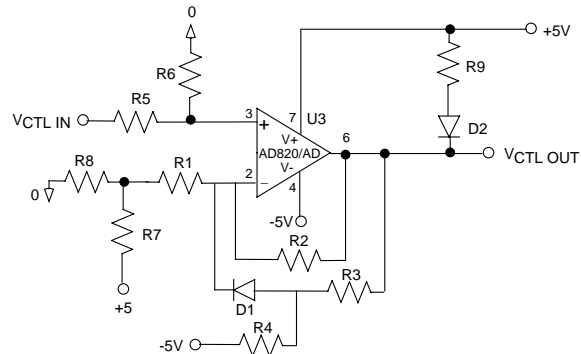

**Return Loss vs. Control Voltage @ 825 MHz**

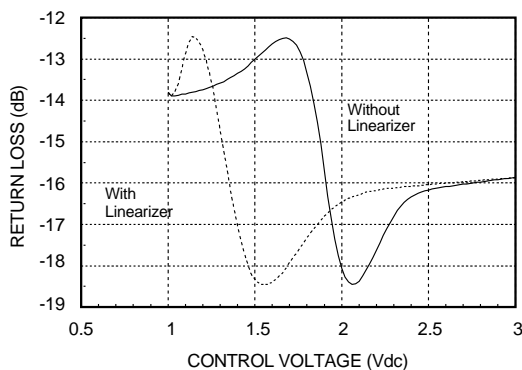

**Attenuation vs. Control Voltage @ 825 MHz**

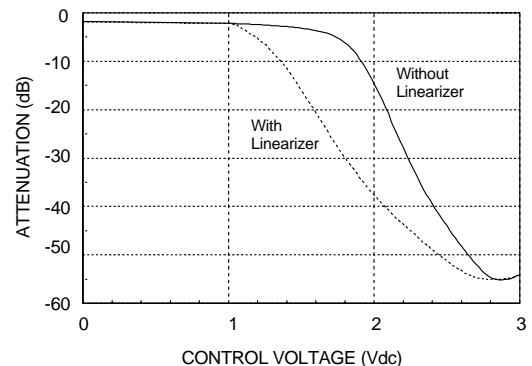

## HMC173MS8 VOLTAGE VARIABLE ATTENUATOR 800-2000 MHz

FEBRUARY 2001

### *Evaluation Circuit Board*

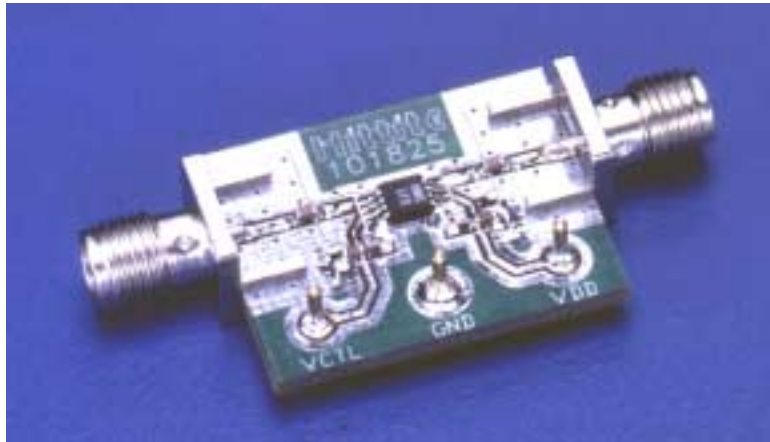

The circuit board used in the final application should use RF circuit design techniques. Signal lines should have 50 ohm impedance while the package ground leads should be connected directly to the ground plane similar to that shown below. A sufficient number of VIA holes should be used to connect the top and bottom ground planes. The evaluation circuit board as shown is available from Hittite upon request.

2

ATTENUATORS

SMT



### *Evaluation Circuit Board Layout Design Details*

Layout Technique	Grounded Co-Planar Waveguide (GCPW)
Material	FR4
Dielectric Thickness	0.028" (0.71 mm)
50 Ohm Line Width	0.037" (0.94 mm)
Gap to Ground Edge	0.010" (0.25 mm)
Ground VIA Hole Diameter	0.014" (0.36 mm)
Connectors	SMA-F (EF - Johnson P/N 142-0701-806)