

TOSHIBA PHOTOINTERRUPTER INFRARED LED+PHOTO IC

TLP1215(C1), TLP1215(C7)

COPIER, LASER BEAM PRINTER

FACSIMILE, PRINTER, ELECTRONIC TYPEWRITER

AUTOMATIC VENDING MACHINE, TERMINAL EQUIPMENT IN BANKING FACILITIES

VARIOUS POSITION DETECTION SENSOR

The TLP1215 (C1) and 1215 (C7) are digital output photointerrupters having a connector with a GaAs infrared LED and a high sensitivity and low current consumption Si photo IC combined.

The output becomes high level when the light is shielded.

This product is also usable in applications requiring severe using temperature condition such as detection of paper exit on copier, etc.

- Small package
- Mountable by one touch. (Snap-in mounting type)
- Mountable to boards in 2 kinds of thickness (1.0mm, 1.2mm)
- For 5V of power supply voltage
- Digital output (open collector)
- Gap : 5mm
- Resolution : Slit width 0.5mm
- Large operating temperature range : $T_{opr} = -25 \sim 90^{\circ}C$
- Low current consumption : $I_{CC} = 16mA$ (max)
- UL recognized PWB adopted : UL94V-0
- Material of the case : Polycarbonate
- Connectors
 - TLP1215 (C1) 172429-3 (AMP (Japan), Ltd. made Ultrex connector)
 - TLP1215 (C7) TXL-P03P-A1 (Taiko Deiki Co., Ltd. made TXL-P Series connector)

961001EBC2

● TOSHIBA is continually working to improve the quality and the reliability of its products. Nevertheless, semiconductor devices in general can malfunction or fail due to their inherent electrical sensitivity and vulnerability to physical stress. It is the responsibility of the buyer, when utilizing TOSHIBA products, to observe standards of safety, and to avoid situations in which a malfunction or failure of a TOSHIBA product could cause loss of human life, bodily injury or damage to property. In developing your designs, please ensure that TOSHIBA products are used within specified operating ranges as set forth in the most recent products specifications. Also, please keep in mind the precautions and conditions set forth in the TOSHIBA Semiconductor Reliability Handbook.

● Gallium arsenide (GaAs) is a substance used in the products described in this document. GaAs dust and fumes are toxic. Do not break, cut or pulverize the product, or use chemicals to dissolve them. When disposing of the products, follow the appropriate regulations. Do not dispose of the products with other industrial waste or with domestic garbage.

● The products described in this document are subject to foreign exchange and foreign trade control laws.

● The information contained herein is presented only as a guide for the applications of our products. No responsibility is assumed by TOSHIBA CORPORATION for any infringements of intellectual property or other rights of the third parties which may result from its use. No license is granted by implication or otherwise under any intellectual property or other rights of TOSHIBA CORPORATION or others.

● The information contained herein is subject to change without notice.

OUTLINE DRAWINGS

單位 : mm

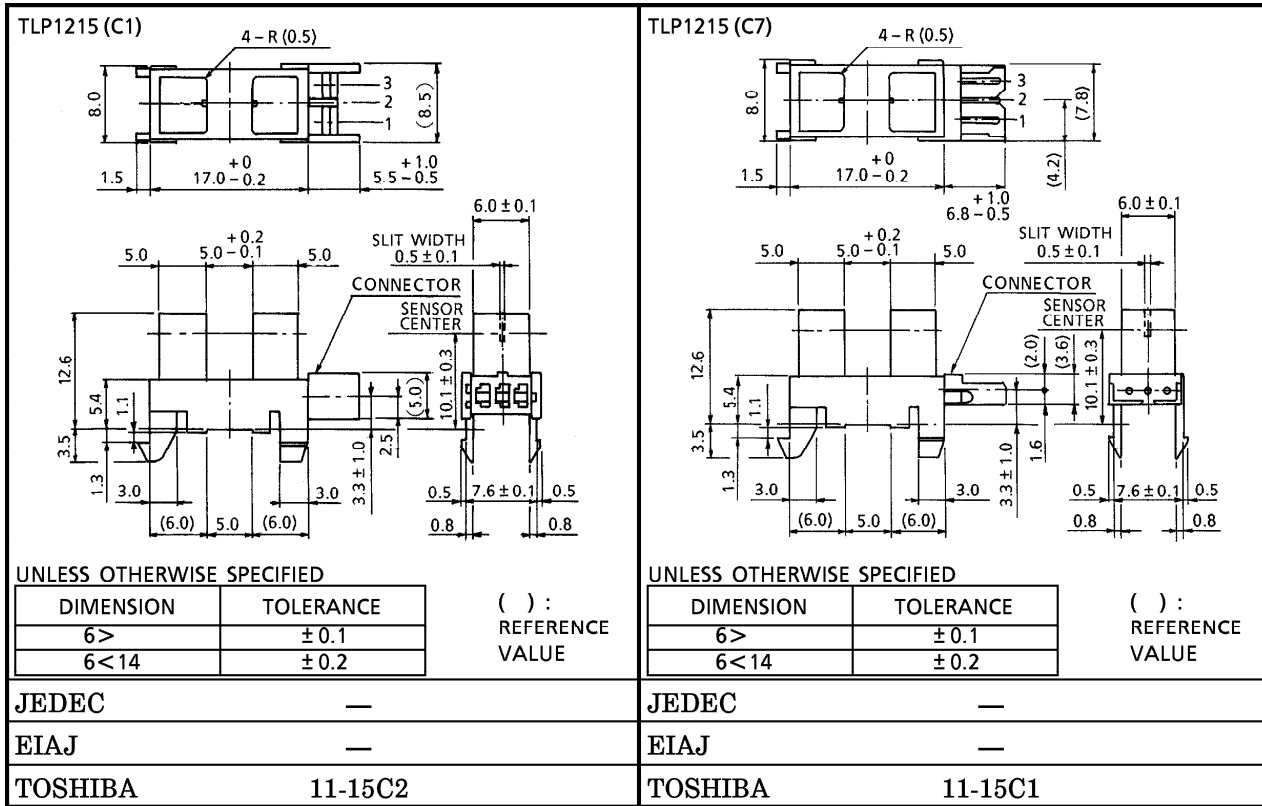

Weight : 1.1g (typ.)

PIN CONNECTION

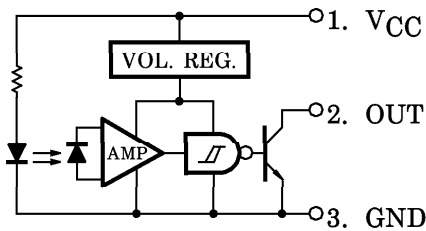

MAXIMUM RATINGS (Ta = 25°C)

CHARACTERISTIC	SYMBOL	RATING	UNIT
Supply Voltage	V _{CC}	10	V
Output Voltage	V _O	28	V
Low Level Output Current	I _{O_L}	50	mA
Low Level Output Current Derating (Ta > 25°C)	ΔI _{O_L} / °C	-0.67	mA / °C
Operating Temperature Range	T _{opr}	-25~90	°C
Storage Temperature Range	T _{stg}	-40~90	°C

RECOMMENDED OPERATING CONDITIONS

CHARACTERISTIC	SYMBOL	MIN.	TYP.	MAX.	UNIT
Supply Voltage	V _{CC}	4.5	5.0	5.5	V
Output Voltage	V _O	—	5.0	17	V
Low Level Output Current	I _{O_L}	—	—	16	mA
Operating Temperature	T _{opr}	-25	—	90	°C

OPTO-ELECTRICAL CHARACTERISTICS (Unless Otherwise Specified, Ta = -25~90°C, V_{CC} = 5V ± 10%)

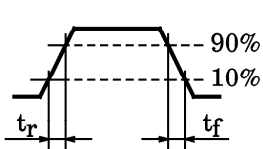
CHARACTERISTIC	SYMBOL	TEST CONDITION	MIN.	TYP.	MAX.	UNIT
Supply Voltage	V _{CC}		4.5	5	5.5	V
Supply Current	High Level	I _{CC_H} Shutter In	—	—	16.5	mA
	Low Level	I _{CC_L} Without Shutter	—	—	16.5	
Output Voltage	High Level	V _{OH} Shutter In, R _L = 47kΩ	0.9V _{CC}	—	—	V
	Low Level	V _{OL} Without Shutter, I _{O_L} = 16mA, Ta = 25°C	—	0.07	0.35	
Without Shutter, I _{O_L} = 16mA			—	—	0.4	
Peak Emission Wavelength	λ _P	Ta = 25°C, LED Side	—	940	—	nm
Peak Sensitivity Wavelength	λ _P	Ta = 25°C, Photo IC Side	—	900	—	nm
Response Frequency	f	R _L = 47kΩ, Ta = 25°C (Note)	3000	—	—	Hz
Rise Time	t _r		—	8	—	μs
Fall Time	t _f		—	0.08	—	

(Note) A value measured when the disc shown in the following figure was rotated. No DC current should be output.

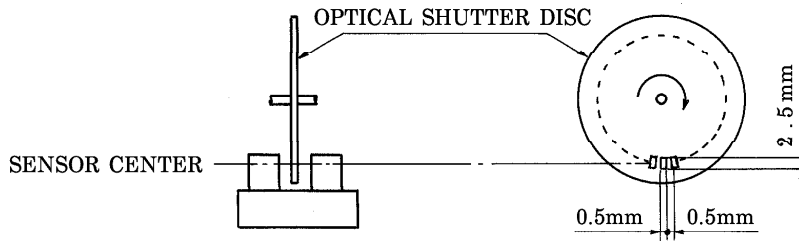

TERMINAL STRENGTH (Ta = 25°C)

CHARACTERISTIC	TEST CONDITION		LIMIT
PULL	DIRECTION	A	NO DEFECT OF ELECTRICAL CHARACTERISTICS
	WEIGHT	19.6N	
	TIME	5s / ONCE	
BEND	DIRECTION	B	
	WEIGHT	9.8N	
	TIME	5s / THRICE	

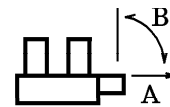

PRECAUTION

Please be careful of the followings.

1. During 100 μ s after turning on V_{CC}, output voltage changes for stabilizing the inner circuit.
2. When installing, avoid to work by holding the connector by hand. Always, install by holding the main body of the element while assuring the mounting board is not warped or twisted. The connectors shall be inserted or pulled out at normal temperature.
3. It is recommended to mount this product by inserting from the sheet metal pressed side.
4. The container is made of polycarbonate. Polycarbonate is usually stable with acid, alcohol, and aliphatic hydrocarbons however, with peroxochemicals (such as benzene, toluene, and acetone), alkali, aromatic hydrocarbons, or chloric hydrocarbons, polycarbonate becomes cracked, swollen, or melted. Please take care when choosing a packaging material by referencing the table below.

<Chemicals to avoid with polycarbonate>

	PHENOMENON	CHEMICALS
A	Little deterioration but staining	<ul style="list-style-type: none"> • nitric acid (low concentration), hydrogen peroxide, chlorine
B	Cracked, crazed, or swollen	<ul style="list-style-type: none"> • acetic acid (70% or more) • gasoline • methyl ethyl ketone, ethyl acetate, butyl acetate • ethyl methacrylate, ethyl ether, MEK • acetone, m-amino alcohol, carbon tetrachloride • carbon disulfide, trichloroethylene, cresol • thinners, oil of turpentine • triethanolamine, TCP, TBP
C	Melted { } : Used as solvent.	<ul style="list-style-type: none"> • concentrated sulfuric acid • benzene • styrene, acrylonitrile, vinyl acetate • ethylenediamine, diethylenediamine • {chloroform, methyl chloride, tetrachloromethane, dioxane, } {1, 2-dichloroethane }
D	Decomposed	<ul style="list-style-type: none"> • ammonia water • other alkali

RECOMMENDABLE MATCHED CONNECTOR

TLP1215 (C1)
AMP (Japan), Ltd. made ultrex connector

HOUSING	172426-3				
TERMINAL	TYPE No.	PRODUCT FORM	MATERIAL	AWG SIZE	INSULATION DIAMETER
	170495-1	LINKED	PHOSPHOR BRONZE	AWG22~26	1.0~1.4mm
	170496-1	LOOSEN			
	170494-1	LINKED		AWG26~30	0.9~1.3mm
170493-1	LOOSEN				

TLP1215 (C7)
Taiko Denki Co., Ltd. made TXL-P series connector

HOUSING	TXL-P03H-A1				
TERMINAL	TYPE No.	PRODUCT FORM	MATERIAL	AWG SIZE	INSULATION DIAMETER
	085T-1100	LINKED	PHOSPHOR BRONZE	AWG26~30	1.5mm MAX.

For details of the connectors, please refer to the connector maker.

PRODUCT INDICATION

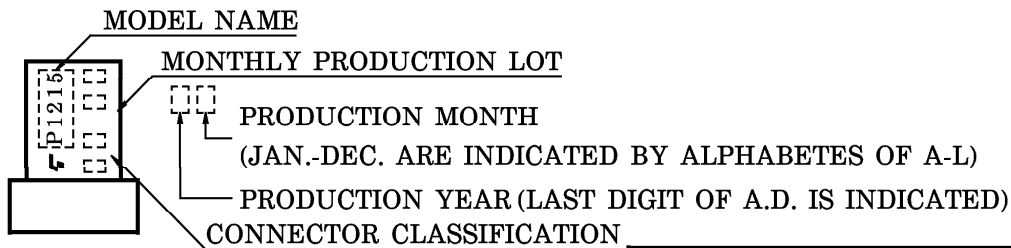

STAMP COLOR : SILVER

TYPE	ABBREVIATION	CONNECTOR CLASSIFICATION
TLP1215 (C1)	P1215	C1
TLP1215 (C7)	P1215	C7

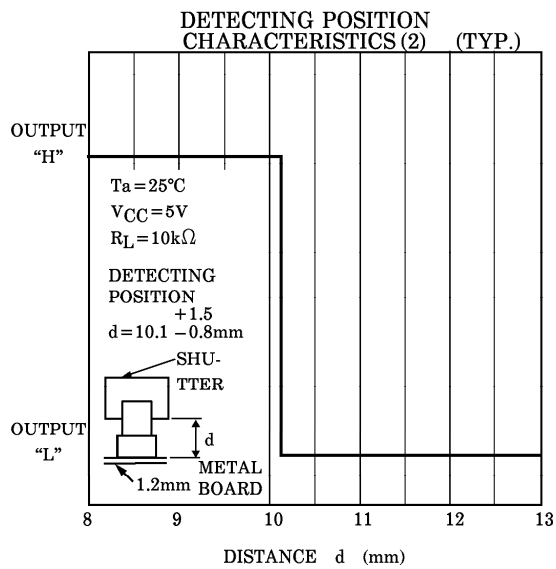
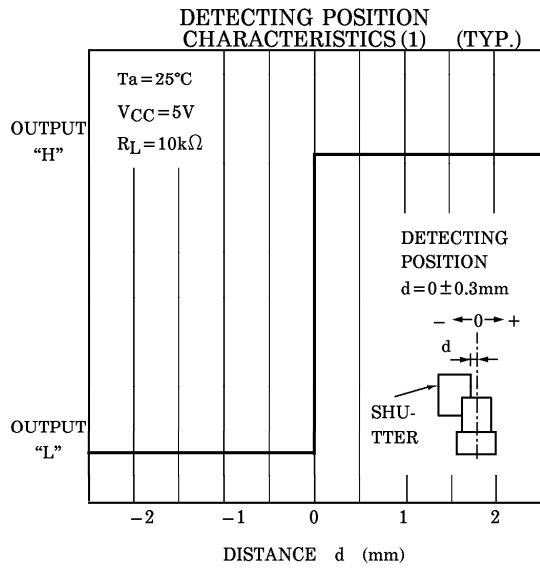
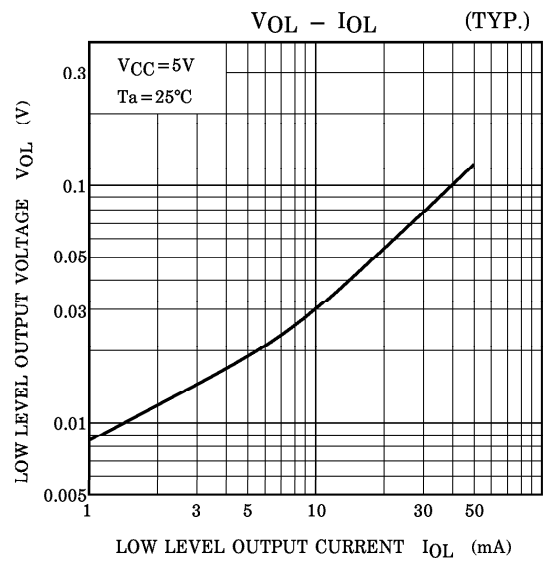
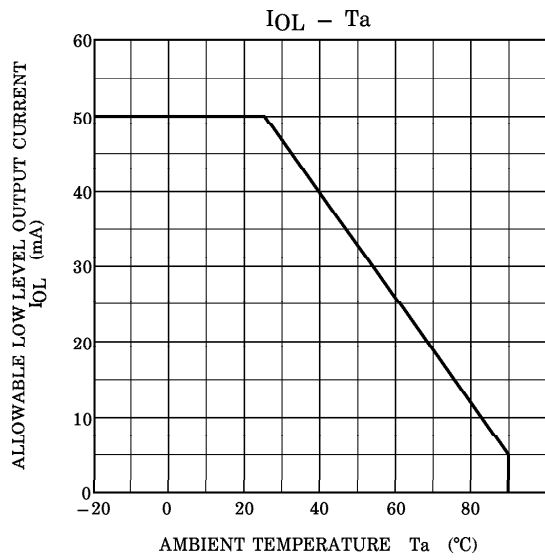

POSITIONING OF SHUTTER AND DEVICE

To operate correctly, make sure that the shutter and the device are positioned as shown in the figure below.

The slit pitch of the shutter must be set wider than the slit width of the device.
 Determine the width taking the switching time into consideration.

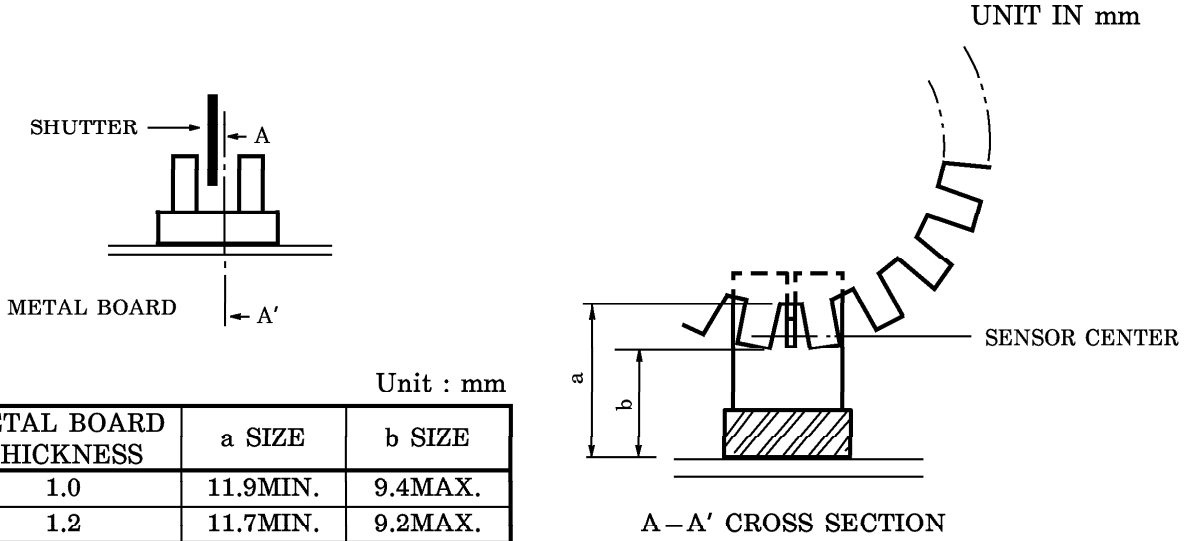

Unit : mm

METAL BOARD THICKNESS	a SIZE	b SIZE
1.0	11.9MIN.	9.4MAX.
1.2	11.7MIN.	9.2MAX.

RECOMMENDED MOUNTING HOLE

