

Advance Information

512K x 9 Bit Separate I/O Synchronous Fast Static RAM

The MCM67Q909 is a 4M-bit static random access memory, organized as 512K words of 9 bits. It features separate TTL input and output buffers, which drive 3.3 V output levels, and incorporates input and output registers on-board with high speed SRAM. It also features transparent-write and data pass-through capabilities.

The synchronous design allows for precise cycle control with the use of an external single clock (K). The addresses (A0 – A18), data input (D0 – D8), data output (Q0 – Q8), write-enable (W), chip-enable (E), and output-enable (G), are registered on the rising edge of clock (K).

The control pins (E, W, G) function differently in comparison to most synchronous SRAMs. This device will not deselect with E high. The RAM remains active at all times. If E is registered high, the output pins (Q0 – Q8) will be driven if G is registered low. The transparent write feature allows the output data to track the input data. E, G, and W must be asserted to perform a transparent write (write and pass-through). The input data is available at the outputs on the next rising edge of clock (K).

The pass-through function is always enabled. E high disables the write to the array while allowing a pass-through cycle to occur on the next rising edge of clock (K). Only a registered G high will three-state the outputs.

The MCM67Q909 is available in an 86-bump surface mount PBGA (Plastic Ball Grid Array) package.

- Single 5 V ± 5% Power Supply
- Fast Cycle Time: 12 ns Max
- Single Clock Operation
- TTL Input and Output Levels (Outputs LVTTTL Compatible)
- Address, Data Input, E, W, and G Registers On-Chip
- 83 MHz Maximum Clock Cycle Time
- Self-Timed Write
- Separate Data Input and Output Pins
- Transparent-Write and Pass-Through
- High Output Drive Capability: 50 pF/Output at Rated Access Time
- Boundary Scan Implementation
- PBGA Package for High Speed Operation

MCM67Q909

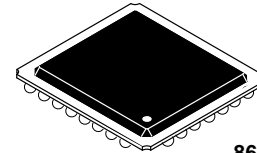

86 BUMP PBGA
CASE 896A-02

PIN NAMES

A0 – A18	Address Input
E	Chip Enable
W	Write Enable
G	Output Enable
D0 – D8	Data Inputs
Q0 – Q8	Data Outputs
K	Clock Input
SCK	Scan Clock Input
SE	Scan Enable
SDI	Scan Data Input
SDO	Scan Data Output
VCC	+ 5 V Power Supply
VSS	Ground
NC	No Connection

PIN ASSIGNMENT

	1	2	3	4	5	6	7	8	9
A		○	○	○	○	○	○	○	
		E	W	VCC	SDI	SDO	A4	A0	
B	○	○	○	○	○	○	○	○	○
	A16	A14	G	K	VSS	A6	A2	VSS	D8
C	○	○	○	○	○	○	○	○	○
	D7	A15	A17	VSS	VSS	VSS	VSS	Q8	VSS
D	○	○	○	○	○	○	○	○	○
	VSS	Q7	VSS	VSS	VSS	VSS	VSS	Q6	D6
E	○	○	○	○	○	○	○	○	○
	D5	VSS	VSS	VSS	VSS	VSS	VSS	VSS	VCC
F	○	○	○	○	○	○	○	○	○
	VCC	Q5	VSS	VSS	VSS	VSS	VSS	D4	Q4
G	○	○	○	○	○	○	○	○	○
	D3	Q3	VSS	VSS	VSS	VSS	VSS	D2	Q2
H	○	○	○	○	○	○	○	○	○
	VSS	D1	A18	VSS	VSS	VSS	VSS	D0	VSS
J	○	○	○	○	○	○	○	○	○
	Q1	A12	A10	VSS	A9	A8	A5	A1	Q0
K	○	○	○	○	○	○	○	○	○
	A13	A11	SCK	VCC	SE	A7	A3		

TOP VIEW
86-BUMP

Not to Scale

This document contains information on a new product. Specifications and information herein are subject to change without notice.

BLOCK DIAGRAM

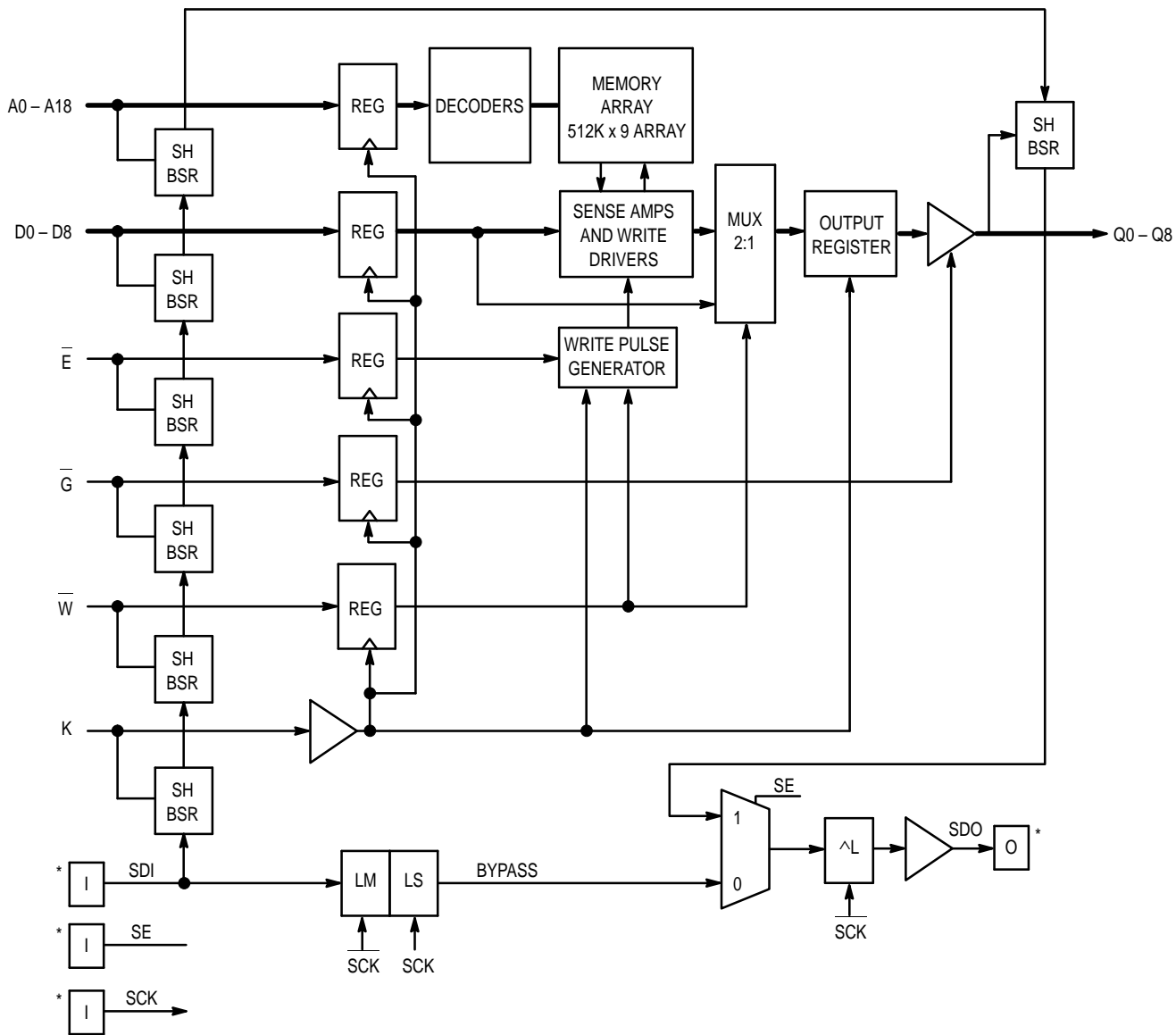

NOTES:

1. Bypass mode is entered with SE low and SCK cycled.
2. SH BSR = shadow bypass scan register.
3. 41 bumps used in boundary scan. V_{SS}, V_{CC}, NC, SDI, SDO, SE, and SCK not used in scan path.
4. SDO output sequence: A6, A4, A2, A0, D8, Q8, D6, Q6, D4, Q4, D2, Q2, D0, Q0, A18, A1, A3, A5, A7, A8, A9, A10, A11, A12, A13, Q1, D1, Q3, D3, Q5, D5, Q7, D7, A15, A16, A14, A17, E, G, W, K.

* Four added test pins.

TRUTH TABLE

E (t_n)	W (t_n)	G (t_{n+1})	Mode	D0 – D8 (t_n)	Q0 – Q8 (t_{n+1})	V _{CC} Current
L	L	L	Write and Pass-Through	Valid	D0 – D8 (t_n)	I _{CC}
		H	Write	Valid	High-Z	I _{CC}
H	L	L	Pass-Through	Valid	D0 – D8 (t_n)	I _{CC}
		H	Pass-Through	Don't Care	High-Z	I _{CC}
X	H	L	Read	Don't Care	Q _{out} (t_n)	I _{CC}
		H	Read	Don't Care	High-Z	I _{CC}

ABSOLUTE MAXIMUM RATINGS (See Note)

Rating	Symbol	Value	Unit
Power Supply Voltage	V _{CC}	- 0.5 to + 7.0	V
Voltage Relative to V _{SS} for Any Pin Except V _{CC}	V _{in} , V _{out}	- 0.5 to V _{CC} + 0.5	V
Output Current	I _{out}	± 30	mA
Power Dissipation	P _D	1.7	W
Temperature Under Bias	T _{bias}	- 10 to + 85	°C
Operating Temperature	T _A	0 to + 70	°C
Storage Temperature — Plastic	T _{stg}	- 55 to + 125	°C

NOTE: Permanent device damage may occur if ABSOLUTE MAXIMUM RATINGS are exceeded. Functional operation should be restricted to RECOMMENDED OPERATING CONDITIONS. Exposure to higher than recommended voltages for extended periods of time could affect device reliability.

This is a synchronous device. All synchronous inputs must meet specified setup and hold times with stable logic levels for **ALL** rising edges of clock (K) while the device is selected.

This device contains circuitry to protect the inputs against damage due to high static voltages or electric fields; however, it is advised that normal precautions be taken to avoid application of any voltage higher than maximum rated voltages to these high-impedance circuits.

DC OPERATING CONDITIONS AND CHARACTERISTICS

(V_{CC} = 5.0 V ± 5%, T_A = 0 to + 70°C, Unless Otherwise Noted)

RECOMMENDED OPERATING CONDITIONS AND SUPPLY CURRENTS

Parameter	Symbol	Min	Max	Unit
Supply Voltage (Operating Voltage Range)	V _{CC}	4.75	5.25	V
Input High Voltage	V _{IH}	2.2	V _{CC} + 0.3**	V
Input Low Voltage	V _{IL}	- 0.5*	0.8	V
Input Leakage Current (All Inputs, V _{in} = 0 to V _{CC})	I _{lkg(I)}	—	± 1.0	µA
Output Leakage Current (E = V _{IH} , V _{out} = 0 to V _{CC})	I _{lkg(O)}	—	± 1.0	µA
AC Supply Current (I _{out} = 0 mA) (V _{CC} = max, f = f _{max}) MCM67Q909-12 ns	I _{CCA}	—	230	mA
Output Low Voltage (I _{OL} = + 8.0 mA)	V _{OL}	—	0.4	V
Output High Voltage (I _{OH} = - 4.0 mA)	V _{OH}	2.4	3.3	V

* V_{IL} (min) = - 0.5 V dc; V_{IL} (min) = - 2.0 V ac (pulse width ≤ 20 ns) for I ≤ 20.0 mA.

** V_{IH} (max) = V_{CC} + 0.3 V dc; V_{IH} (max) = V_{CC} + 2.0 V ac (pulse width ≤ 20 ns) for I ≤ 20.0 mA.

CAPACITANCE (f = 1.0 MHz, dV = 3.0 V, T_A = 25°C, Periodically Sampled Rather Than 100% Tested)

Parameter	Symbol	Max	Unit
Address and Data Input Capacitance	C _{in}	6	pF
Control Pin Input Capacitance	C _{in}	6	pF
Output Capacitance	C _{out}	8	pF

AC OPERATING CONDITIONS AND CHARACTERISTICS

(V_{CC} = 5.0 V ± 5%, T_A = 0 to + 70°C, Unless Otherwise Noted)

Input Timing Measurement Reference Level 1.5 V
 Input Pulse Levels 0 to 3.0 V
 Input Rise/Fall Time 3 ns
 Output Timing Reference Level 1.5 V
 Output Load Figure 1 Unless Otherwise Noted

READ/WRITE CYCLE TIMING (See Notes 1, 2, 3 and 4)

Parameter	Symbol	MCM67Q909–12		Unit	Notes	
		Min	Max			
Cycle Time	t _{KHKH}	12	—	ns	1	
Clock Access Time	t _{KHQV}	—	5	ns	2	
Clock Low Pulse Width	t _{KLKH}	4	—	ns		
Clock High Pulse Width	t _{KHKL}	4	—	ns		
Clock High to Data Output Invalid	t _{KHQX}	2	—	ns		
Clock High to Data Output High–Z	t _{KHQZ}	—	5	ns	3	
Setup Times:	$\begin{matrix} \underline{A} \\ \underline{W} \\ \underline{E} \\ \underline{G} \\ \text{D0 – D8} \end{matrix}$	$\begin{matrix} t_{AVKH} \\ t_{WVKH} \\ t_{EVKH} \\ t_{GVKH} \\ t_{DVKH} \end{matrix}$	3	—	ns	4
Hold Times:	$\begin{matrix} \underline{A} \\ \underline{W} \\ \underline{E} \\ \underline{G} \\ \text{D0 – D8} \end{matrix}$	$\begin{matrix} t_{KHAX} \\ t_{KHWX} \\ t_{KHEX} \\ t_{KHGX} \\ t_{KHDX} \end{matrix}$	2	—	ns	4

NOTES:

1. All read and write cycles are referenced from K.
2. Valid data from clock high will be the data stored at the address or the last valid read cycle.
3. Measured at ± 200 mV from steady state.
4. This is a synchronous device. All synchronous inputs must meet the specified setup and hold times with stable logic levels for **ALL** rising edges of clock (K) while the device is selected.

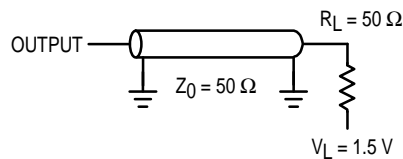
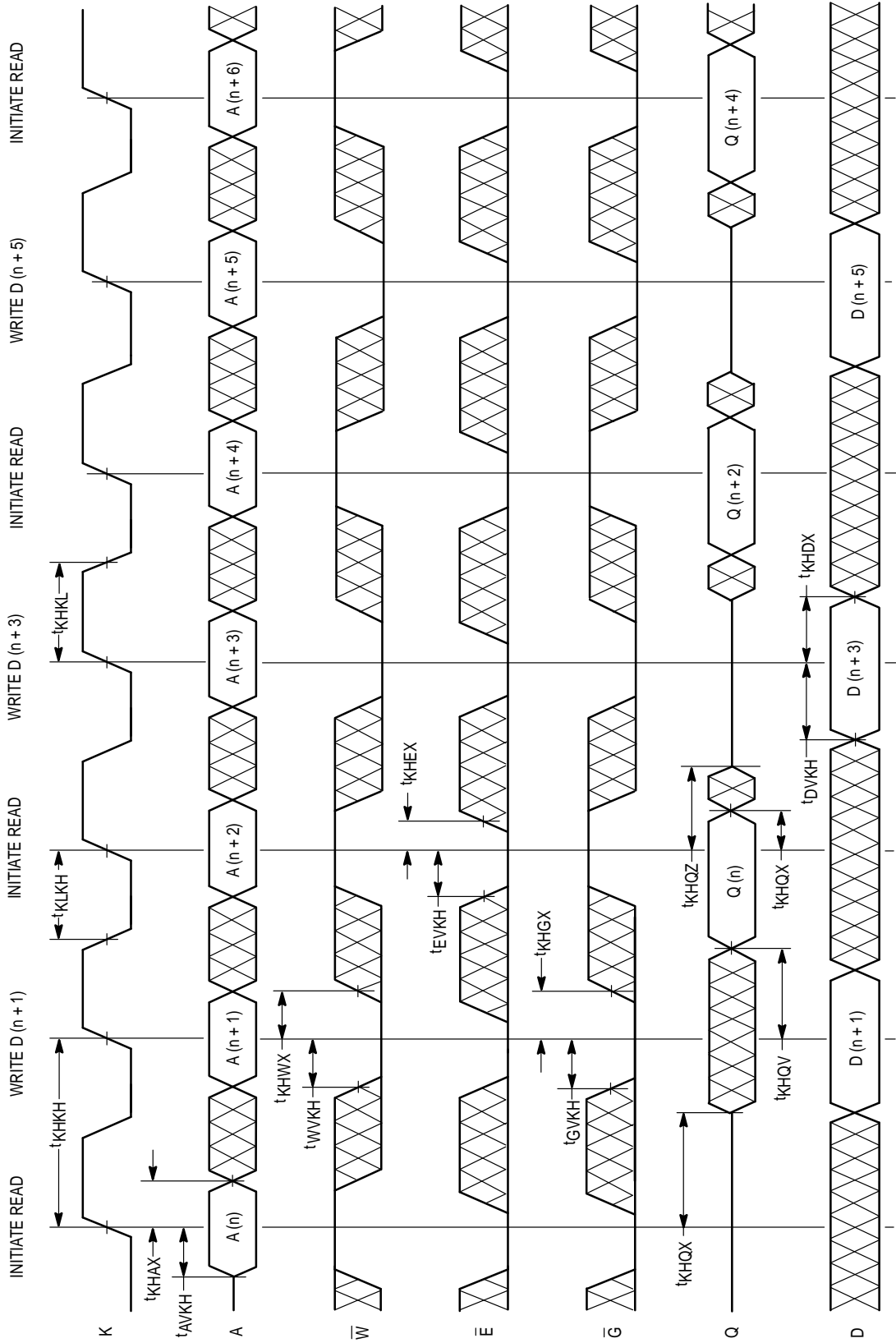
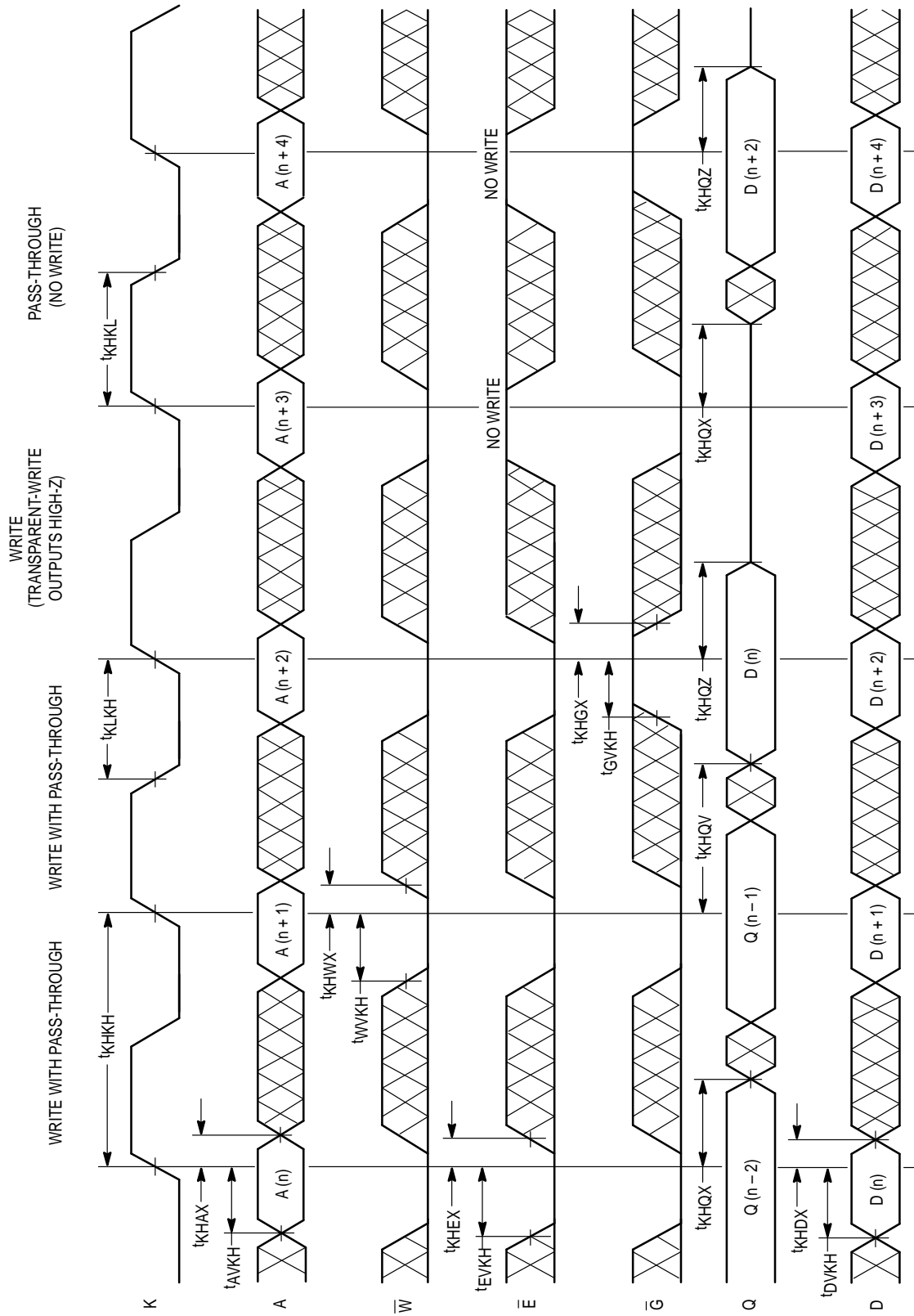

Figure 1. AC Test Load

COMBINATION READ/WRITE CYCLE TIMING



TRANSPARENT-WRITE AND PASS-THROUGH CYCLE TIMING



BOUNDARY SCAN CYCLE TIMING

Parameter	Symbol	MCM67Q909–12		Unit	Notes
		Min	Max		
Cycle Time	t_{CHCH2}	100	—	ns	
Clock High Pulse Width	t_{CHCL2}	40	—	ns	
Clock Low Pulse Width	t_{CLCH2}	40	—	ns	
Scan Mode Setup Time	t_{SS}	10	—	ns	1
Bypass Mode Setup Time	t_{BS}	10	—	ns	2
Scan Mode Recovery Time	t_{SR}	100	—	ns	3
SCK Low to SE Hold High	t_{CLMH}	10	—	ns	4
SE High to SCK High Setup	t_{MHCH}	10	—	ns	5
SCK High to SE Low Hold Time	t_{CHML}	10	—	ns	6
SDI Valid to SCK High Setup	t_{IVCH}	10	—	ns	
SCK High to SDI Don't Care	t_{CHIX}	10	—	ns	
SCK Low to SDO Valid	t_{CLOV}	—	20	ns	

NOTES:

1. The minimum delay required between ending normal operation and beginning scan operations.
2. The minimum delay required between ending shift mode and beginning bypass mode.
3. The minimum delay required before restarting normal RAM operation.
4. The minimum delay required before executing a parallel load operation.
5. The minimum delay required between a parallel load operation and a shift.
6. Minimum shift command hold time.

BOUNDARY SCAN

OVERVIEW

Boundary scan is a simple, non-intrusive scheme that allows verification of electrical continuity for each of a clocked RAMs logically active inputs and I/Os without adversely affecting RAM performance. Boundary scan allows the user to monitor the logic levels applied to each signal I/O on the RAM, and to shift them out in a serial bit stream.

OPERATION

Boundary scan requires four signal pins for implementation: scan data in (SDI), scan data out (SDO), scan clock (SCK, active high), and scan enable (SE, active high).

Boundary scan provides three modes of operation: (1) normal RAM operation, (2) scan, and (3) bypass. For normal RAM operation, SCK and SE must be held low. The RAM will always return to normal operation immediately after the RAM receives a rising edge of the RAM input clock (K) with SCK and SE held low. To enter scan mode, SCK is activated. The first rising edge of SCK is used to latch in the data on the scan registers. SE is then driven high to disable additional input data from entering the scan registers. Every falling edge of SCK serially shifts data through the scan registers and onto the SDO pin. To enter bypass mode, simply exercise SCK with SE held low. In this mode, SDI is sampled on the rising edge of SCK. The level found on SDI is then driven out on SDO on the next falling edge of SCK.

BOUNDARY SCAN TIMING DIAGRAM

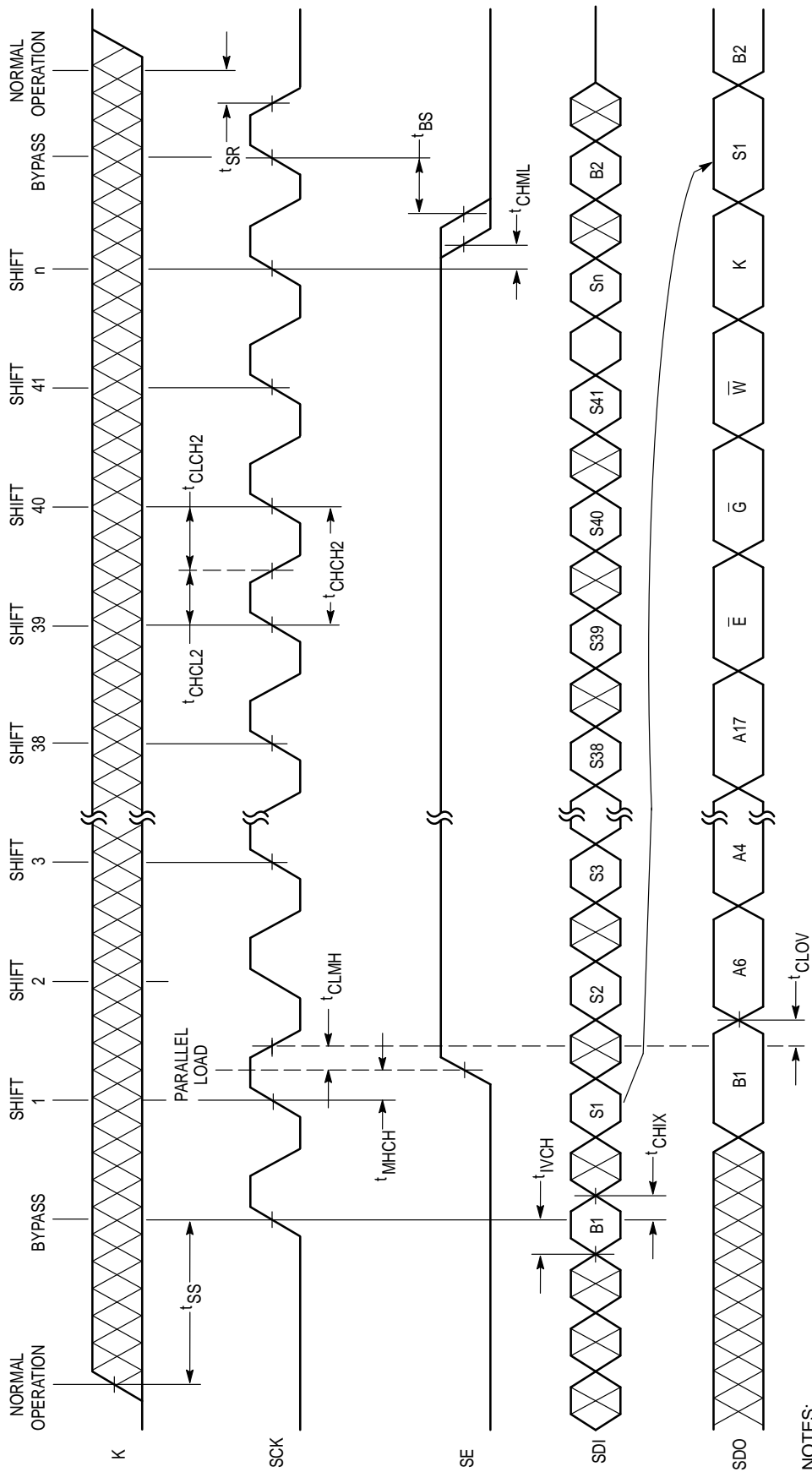

NOTES:

- B1 and B2 = bypass serial data from outside source.
- S1 - S_n + 1 = serial scan data from outside source.
- S1 - S_n = RAMs input register contents.
- Scan order is: A6, A4, A2, A0, D8, Q8, D6, Q6, D4, Q4, D2, Q0, A18, A1, A3, A5, A7, A8, A9, A10, A11, A12, A13, Q1, D1, Q3, D3, Q5, D5, Q7, D7, A15, A16, A14, A17, \bar{E} , \bar{G} , \bar{W} , K.

ORDERING INFORMATION (Order by Full Part Number)

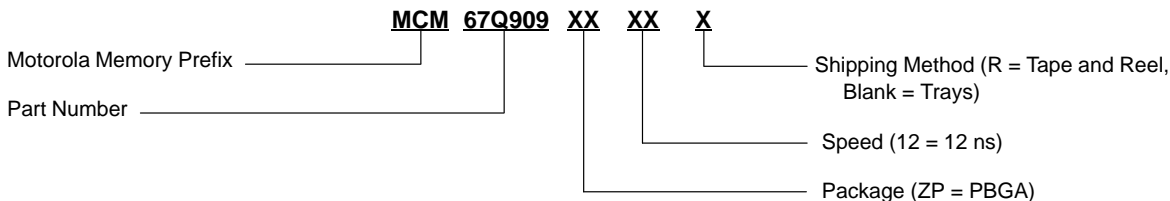

Full Part Numbers — MCM67Q909ZP12
MCM67Q909ZP12R

PACKAGE DIMENSIONS

**ZP PACKAGE
86 PBGA
CASE 896A-02**

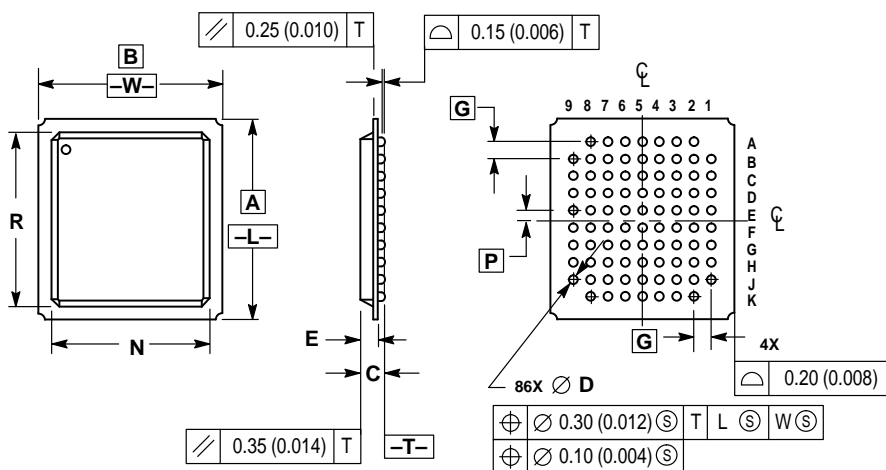

- NOTES:
1. DIMENSIONING AND TOLERANCING PER ANSI Y14.5M, 1982.
2. CONTROLLING DIMENSION: MILLIMETER.

DIM	MILLIMETERS		INCHES	
	MIN	MAX	MIN	MAX
A	17.78 BSC		0.700 BSC	
B	16.26 BSC		0.640 BSC	
C	1.84	2.44	0.073	0.096
D	0.69	0.81	0.028	0.031
E	1.33	1.73	0.053	0.068
G	1.524 BSC		0.060 BSC	
N	13.80	14.20	0.544	0.559
P	0.762 BSC		0.030 BSC	
R	15.29	15.69	0.602	0.617

Motorola reserves the right to make changes without further notice to any products herein. Motorola makes no warranty, representation or guarantee regarding the suitability of its products for any particular purpose, nor does Motorola assume any liability arising out of the application or use of any product or circuit, and specifically disclaims any and all liability, including without limitation consequential or incidental damages. "Typical" parameters which may be provided in Motorola data sheets and/or specifications can and do vary in different applications and actual performance may vary over time. All operating parameters, including "Typicals" must be validated for each customer application by customer's technical experts. Motorola does not convey any license under its patent rights nor the rights of others. Motorola products are not designed, intended, or authorized for use as components in systems intended for surgical implant into the body, or other applications intended to support or sustain life, or for any other application in which the failure of the Motorola product could create a situation where personal injury or death may occur. Should Buyer purchase or use Motorola products for any such unintended or unauthorized application, Buyer shall indemnify and hold Motorola and its officers, employees, subsidiaries, affiliates, and distributors harmless against all claims, costs, damages, and expenses, and reasonable attorney fees arising out of, directly or indirectly, any claim of personal injury or death associated with such unintended or unauthorized use, even if such claim alleges that Motorola was negligent regarding the design or manufacture of the part. Motorola and are registered trademarks of Motorola, Inc. Motorola, Inc. is an Equal Opportunity/Affirmative Action Employer.

Mfax is a trademark of Motorola, Inc.

How to reach us:

USA/EUROPE/Locations Not Listed: Motorola Literature Distribution;
P.O. Box 5405, Denver, Colorado, 80217. 1-303-675-2140 or 1-800-441-2447

JAPAN: Nippon Motorola Ltd.: SPD, Strategic Planning Office, 141,
4-32-1 Nishi-Gotanda, Shagawa-ku, Tokyo, Japan. 03-5487-8488

Mfax™: RMFAX0@email.sps.mot.com — TOUCHTONE 1-602-244-6609
Motorola Fax Back System — US & Canada ONLY 1-800-774-1848
— http://sps.motorola.com/mfax/

ASIA/PACIFIC: Motorola Semiconductors H.K. Ltd.; 8B Tai Ping Industrial Park,
51 Ting Kok Road, Tai Po, N.T., Hong Kong. 852-26629298

HOME PAGE: <http://motorola.com/sps/>

CUSTOMER FOCUS CENTER: 1-800-521-6274

