

TLP120

Programmable Controllers
 AC / DC-Input Module
 Telecommunication

The TOSHIBA mini flat coupler TLP120 is a small outline coupler, suitable for surface mount assembly. TLP120 consists of a photo transistor, optically coupled to two gallium arsenide infrared emitting diode connected inverse parallel, and can operate directly by AC input current.

- Collector-emitter voltage: 80 V (min.)
- Current transfer ratio: 50% (min.)
 Rank GB: 100% (min.)
- Isolation voltage: 3750Vrms (min.)
- UL recognized: UL1577, file no. E67349

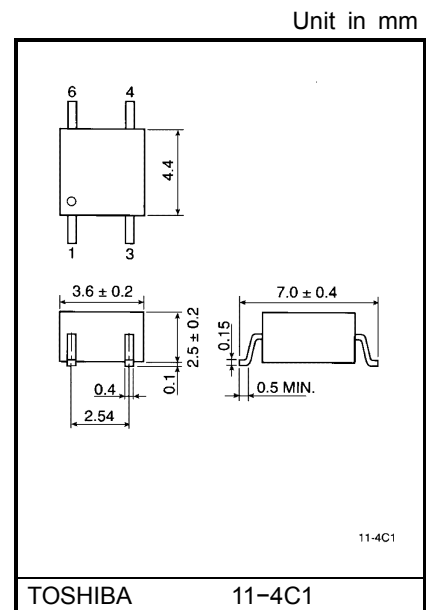

Weight: 0.09 g

Pin Configurations (top view)

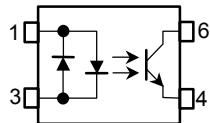

- 1 : Anode
 Cathode
- 3 : Cathode
 Anode
- 4 : Emitter
- 6 : Collector

Maximum Ratings (Ta = 25°C)

Characteristic		Symbol	Rating	Unit
LED	Forward current	$I_{F(RMS)}$	50	mA
	Forward current derating	$\Delta I_F / ^\circ C$	-0.7 (Ta ≥ 53°C)	mA / °C
	Pulse forward current	I_{FP}	1 (100µs pulse, 100pps)	A
	Junction temperature	T_j	125	°C
Detector	Collector-emitter voltage	V_{CEO}	80	V
	Emitter-collector voltage	V_{ECO}	7	V
	Collector current	I_C	50	mA
	Collector power dissipation	P_C	150	mW
	Collector power dissipation derating (Ta ≥ 25°C)	$\Delta P_C / ^\circ C$	-1.5	mW / °C
	Junction temperature	T_j	125	°C
Storage temperature range		T_{stg}	-55~125	°C
Operating temperature range		T_{opr}	-55~100	°C
Lead soldering temperature		T_{sol}	260 (10s)	°C
Total package power dissipation		P_T	200	mW
Total package power dissipation derating (Ta ≥ 25°C)		$\Delta P_T / ^\circ C$	-2.0	mW / °C
Isolation voltage (Note 1)		BV_S	3750 (AC, 1min., R.H. ≤ 60%)	Vrms

(Note 1) Device considered a two terminal device: Pins 1, 3 shorted together and pins 4, 6 shorted together.

Recommended Operating Conditions

Characteristic	Symbol	Min.	Typ.	Max.	Unit
Supply voltage	V_{CC}	—	5	48	V
Forward current	$I_{F(RMS)}$	—	16	20	mA
Collector current	I_C	—	1	10	mA
Operating temperature	T_{opr}	-25	—	85	°C

Individual Electrical Characteristics (Ta = 25°C)

Characteristic		Symbol	Test Condition	Min.	Typ.	Max.	Unit
LED	Forward voltage	V_F	$I_F = \pm 10 \text{ mA}$	1.0	1.15	1.3	V
	Capacitance	C_T	$V = 0, f = 1 \text{ MHz}$	—	60	—	pF
Detector	Collector-emitter breakdown voltage	$V_{(BR)CEO}$	$I_C = 0.5 \text{ mA}$	80	—	—	V
	Emitter-collector breakdown voltage	$V_{(BR)ECO}$	$I_E = 0.1 \text{ mA}$	7	—	—	V
	Collector dark current	I_{CEO}	$V_{CE} = 48 \text{ V}$	—	10	100	nA
			$V_{CE} = 48 \text{ V}, T_a = 85^\circ\text{C}$	—	2	50	μA
Capacitance (collector to emitter)	C_{CE}	$V = 0, f = 1 \text{ MHz}$	—	10	—	pF	

Coupled Electrical Characteristics (Ta = 25°C)

Characteristic	Symbol	Test Condition	Min.	Typ.	Max.	Unit
Current transfer ratio	I_C / I_F	$I_F = \pm 5 \text{ mA}, V_{CE} = 5 \text{ V}$ Rank GB	50	—	600	%
			100	—	600	
Saturated CTR	$I_C / I_F (\text{sat})$	$I_F = \pm 1 \text{ mA}, V_{CE} = 0.4 \text{ V}$ Rank GB	—	60	—	%
			30	—	—	
Collector-emitter saturation voltage	$V_{CE (\text{sat})}$	$I_C = 2.4 \text{ mA}, I_F = \pm 8 \text{ mA}$ $I_C = 0.2 \text{ mA}, I_F = \pm 1 \text{ mA}$ Rank GB	—	—	0.4	V
			—	0.2	—	
Off-state collector current	$I_{C(\text{off})}$	$V_F = \pm 0.7 \text{ V}, V_{CE} = 48 \text{ V}$	—	1	10	μA
CTR symmetry	$I_C (\text{ratio})$	$I_C (I_F = -5 \text{ mA}) / I_C (I_F = 5 \text{ mA})$	0.33	1	3	—

Isolation Characteristics (Ta = 25°C)

Characteristic	Symbol	Test Condition	Min.	Typ.	Max.	Unit
Capacitance (input to output)	C_S	$V_S = 0, f = 1 \text{ MHz}$	—	0.8	—	pF
Isolation resistance	R_S	$V_S = 500 \text{ V}, \text{R.H.} \leq 60\%$	5×10^{10}	10^{14}	—	Ω
Isolation voltage	BV_S	AC, 1 minute	3750	—	—	V_{rms}
		AC, 1 second, in oil	—	10000	—	
		DC, 1 minute, in oil	—	10000	—	V_{dc}

Switching Characteristics (Ta = 25°C)

Characteristic	Symbol	Test Condition	Min.	Typ.	Max.	Unit
Rise time	t_r	$V_{CC} = 10\text{ V}, I_C = 2\text{ mA}$ $R_L = 100\Omega$	—	2	—	μs
Fall time	t_f		—	3	—	
Turn-on time	t_{on}		—	3	—	
Turn-off time	t_{off}		—	3	—	
Turn-on time	t_{ON}	$R_L = 1.9\text{ k}\Omega$ $V_{CC} = 5\text{ V}, I_F = \pm 16\text{ mA}$ (Fig.1)	—	2	—	μs
Storage time	t_s		—	25	—	
Turn-off time	t_{OFF}		—	40	—	

Fig. 1 Switching time test circuit

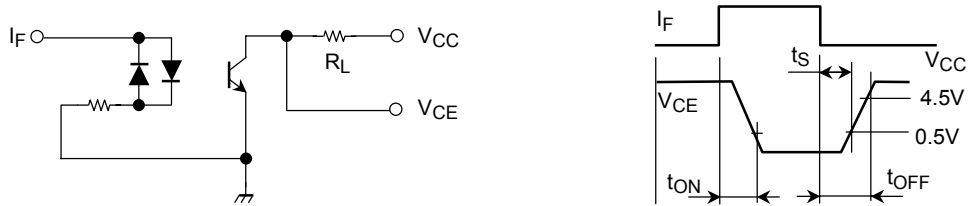

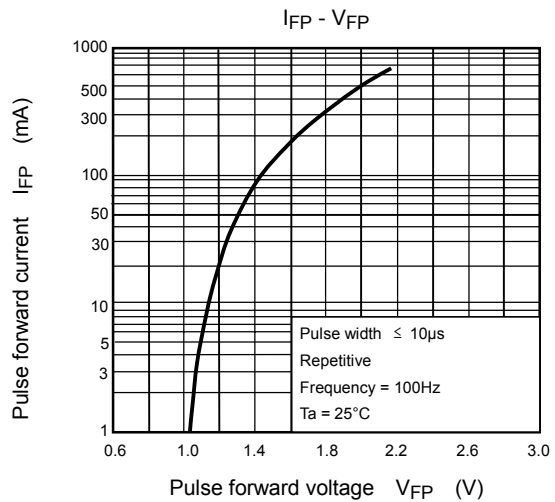
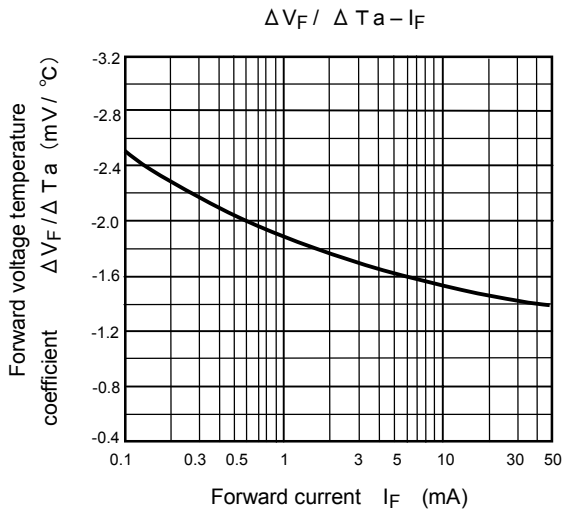
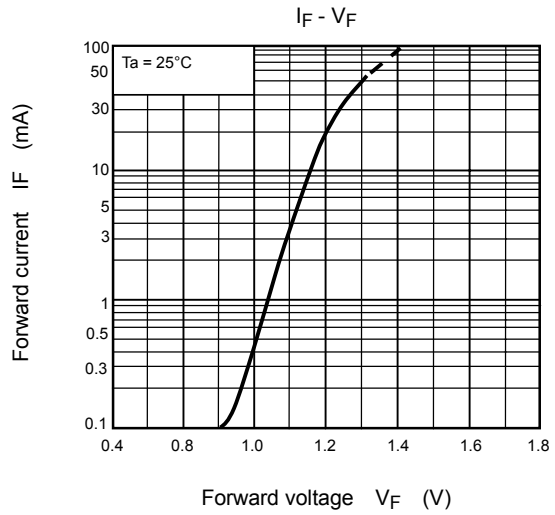
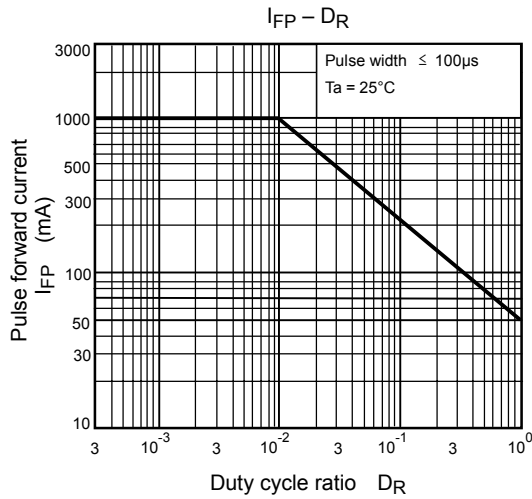
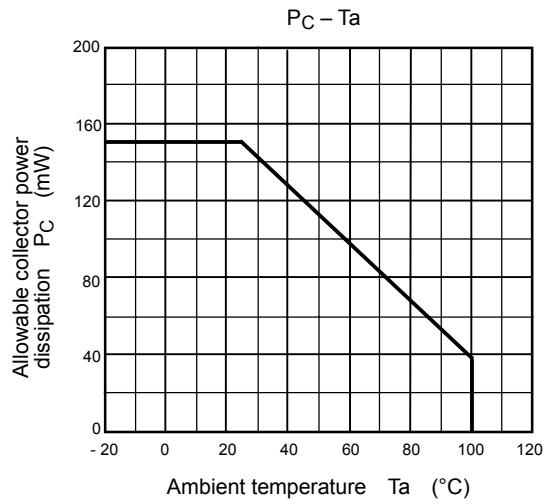
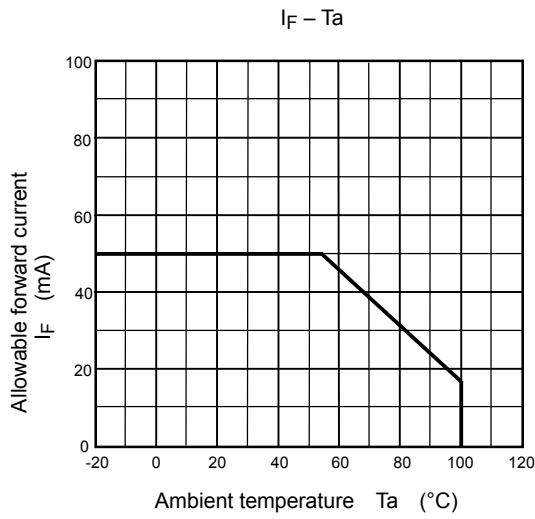

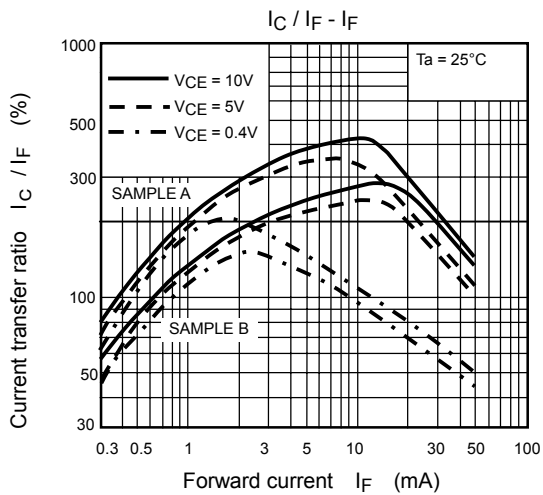
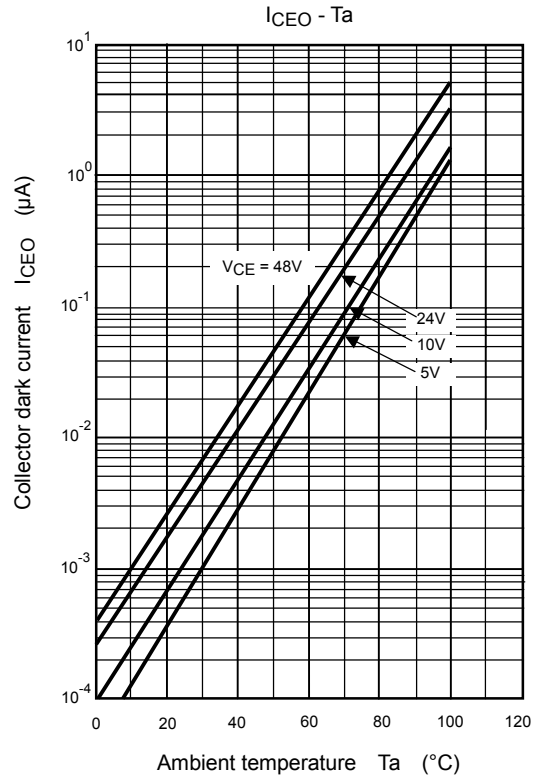
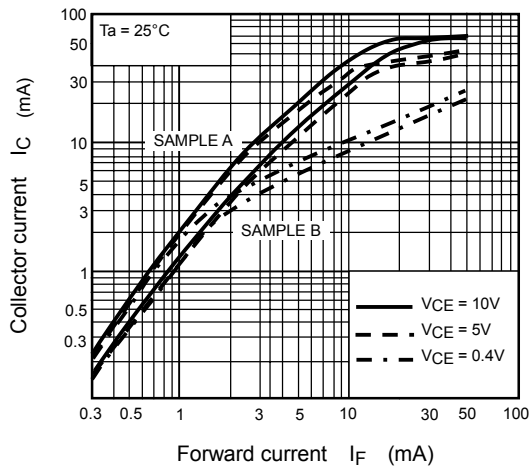
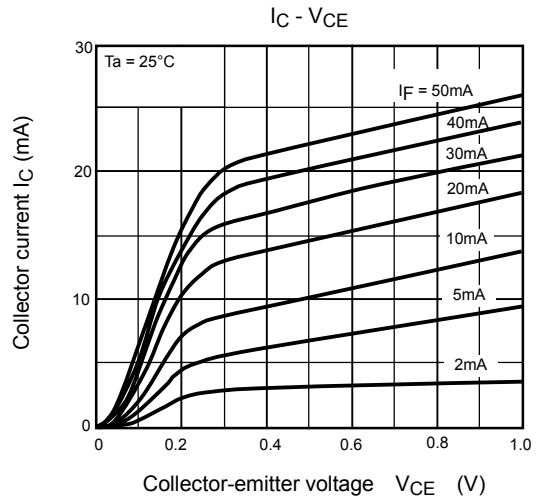
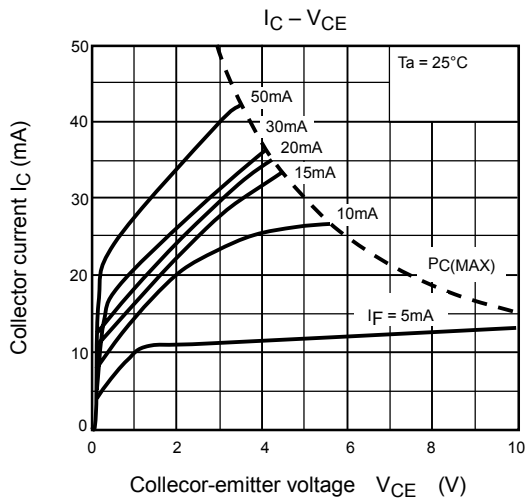

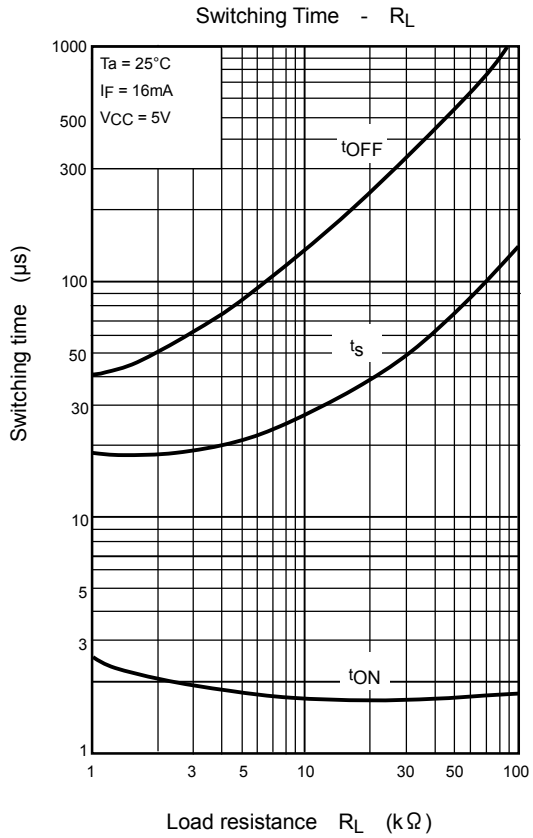
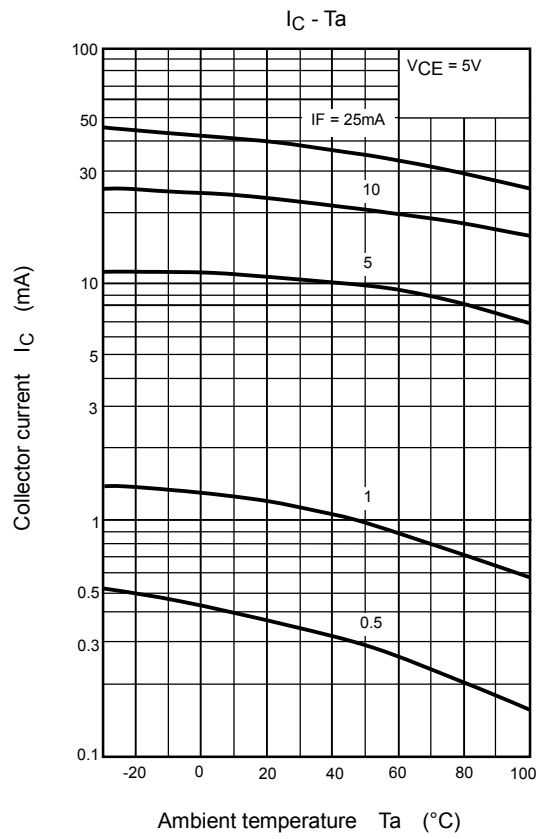
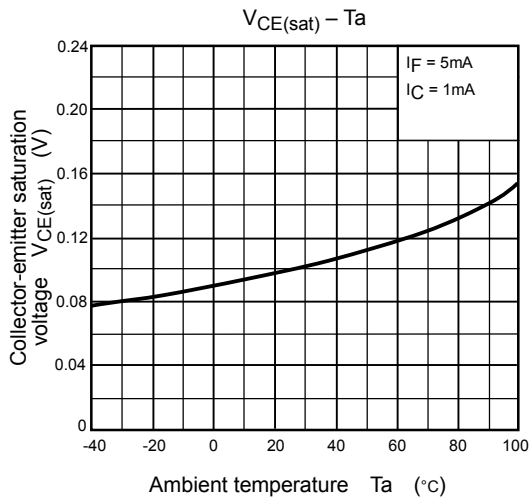

RESTRICTIONS ON PRODUCT USE

000707EBC

- TOSHIBA is continually working to improve the quality and reliability of its products. Nevertheless, semiconductor devices in general can malfunction or fail due to their inherent electrical sensitivity and vulnerability to physical stress. It is the responsibility of the buyer, when utilizing TOSHIBA products, to comply with the standards of safety in making a safe design for the entire system, and to avoid situations in which a malfunction or failure of such TOSHIBA products could cause loss of human life, bodily injury or damage to property.
In developing your designs, please ensure that TOSHIBA products are used within specified operating ranges as set forth in the most recent TOSHIBA products specifications. Also, please keep in mind the precautions and conditions set forth in the "Handling Guide for Semiconductor Devices," or "TOSHIBA Semiconductor Reliability Handbook" etc..
- The TOSHIBA products listed in this document are intended for usage in general electronics applications (computer, personal equipment, office equipment, measuring equipment, industrial robotics, domestic appliances, etc.). These TOSHIBA products are neither intended nor warranted for usage in equipment that requires extraordinarily high quality and/or reliability or a malfunction or failure of which may cause loss of human life or bodily injury ("Unintended Usage"). Unintended Usage include atomic energy control instruments, airplane or spaceship instruments, transportation instruments, traffic signal instruments, combustion control instruments, medical instruments, all types of safety devices, etc.. Unintended Usage of TOSHIBA products listed in this document shall be made at the customer's own risk.
- Gallium arsenide (GaAs) is a substance used in the products described in this document. GaAs dust and fumes are toxic. Do not break, cut or pulverize the product, or use chemicals to dissolve them. When disposing of the products, follow the appropriate regulations. Do not dispose of the products with other industrial waste or with domestic garbage.
- The products described in this document are subject to the foreign exchange and foreign trade laws.
- The information contained herein is presented only as a guide for the applications of our products. No responsibility is assumed by TOSHIBA CORPORATION for any infringements of intellectual property or other rights of the third parties which may result from its use. No license is granted by implication or otherwise under any intellectual property or other rights of TOSHIBA CORPORATION or others.
- The information contained herein is subject to change without notice.