

## POWER SCHOTTKY RECTIFIER

### MAIN PRODUCT CHARACTERISTICS

<b>I<sub>F(AV)</sub></b>	<b>15 A</b>
<b>V<sub>RRM</sub></b>	<b>45 V</b>
<b>T<sub>j</sub> (max)</b>	<b>175 °C</b>
<b>V<sub>F</sub> (max)</b>	<b>0.57 V</b>

### FEATURES AND BENEFITS

- VERY SMALL CONDUCTION LOSSES
- NEGLIGIBLE SWITCHING LOSSES
- EXTREMELY FAST SWITCHING
- INSULATED PACKAGE: ISOWATT220AC  
Insulating voltage = 2000V DC  
Capacitance = 12pF

### DESCRIPTION

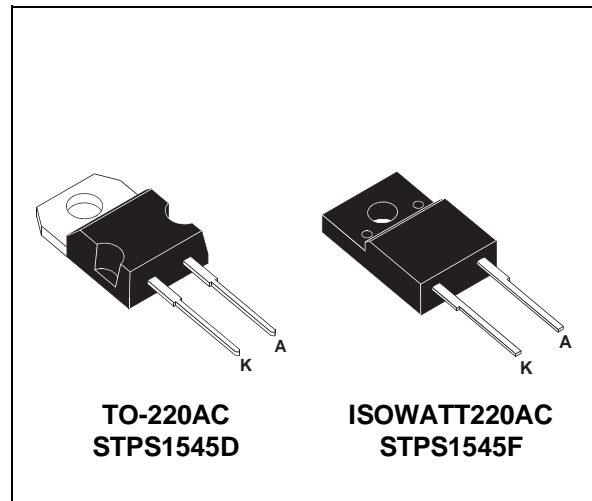
Single chip Schottky rectifier suited for Switch Mode Power Supply and high frequency DC to DC converters.

Packaged in TO-220AC or ISOWATT2230AC, this device is intended for use in low voltage, high frequency inverters, free wheeling and polarity protection applications.

### ABSOLUTE RATINGS (limiting values)

Symbol	Parameter		Value	Unit
V <sub>RRM</sub>	Repetitive peak reverse voltage		45	V
I <sub>F(RMS)</sub>	RMS forward current		30	A
I <sub>F(AV)</sub>	Average forward current δ = 0.5	TO-220AC	15	A
		ISOWATT220AC		
I <sub>FSM</sub>	Surge non repetitive forward current	tp = 10 ms Sinusoidal	220	A
I <sub>R(RM)</sub>	Repetitive peak reverse current	tp = 2 μs square F = 1kHz	1	A
I <sub>R(SM)</sub>	Non repetitive peak reverse current	tp = 100 μs square	3	A
T <sub>stg</sub>	Storage temperature range		- 65 to + 175	°C
T <sub>j</sub>	Maximum operating junction temperature *		175	°C
dV/dt	Critical rate of rise of reverse voltage		10000	V/μs

\* :  $\frac{dP_{tot}}{dT_j} < \frac{1}{R_{th(j-a)}}$  thermal runaway condition for a diode on its own heatsink



## STPS1545D/F

### THERMAL RESISTANCES

Symbol	Parameter		Value	Unit
R <sub>th(j-c)</sub>	Junction to case	TO-220AC	1.6	°C/W
		ISOWATT220AC	4.0	

### STATIC ELECTRICAL CHARACTERISTICS

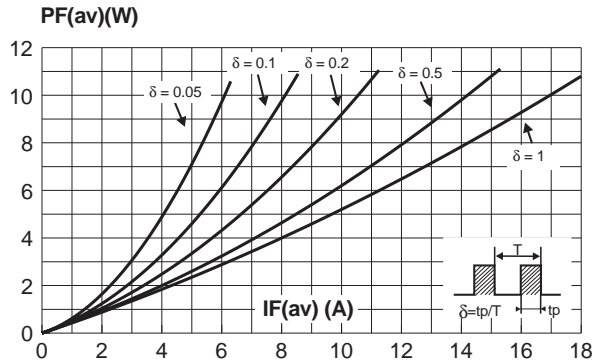
Symbol	Parameter	Tests Conditions		Min.	Typ.	Max.	Unit
I <sub>R</sub> *	Reverse leakage current	T <sub>j</sub> = 25°C	V <sub>R</sub> = V <sub>R</sub> RM			200	μA
		T <sub>j</sub> = 125°C			11	40	mA
V <sub>F</sub> *	Forward voltage drop	T <sub>j</sub> = 125°C	I <sub>F</sub> = 15 A		0.5	0.57	V
		T <sub>j</sub> = 25°C	I <sub>F</sub> = 30 A			0.84	
		T <sub>j</sub> = 125°C	I <sub>F</sub> = 30 A		0.65	0.72	

Pulse test : \* tp = 380 μs, δ < 2%

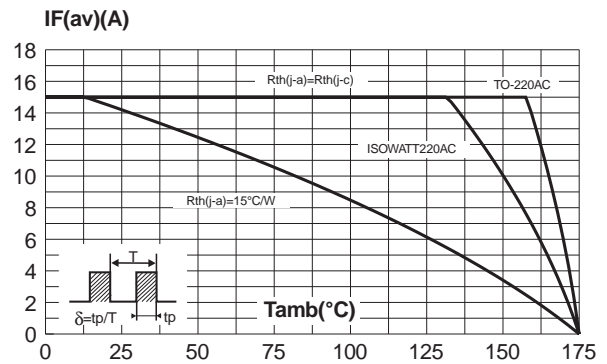
To evaluate the conduction losses use the following equation :

$$P = 0.42 \times I_{F(AV)} + 0.01 I_{F(RMS)}^2$$

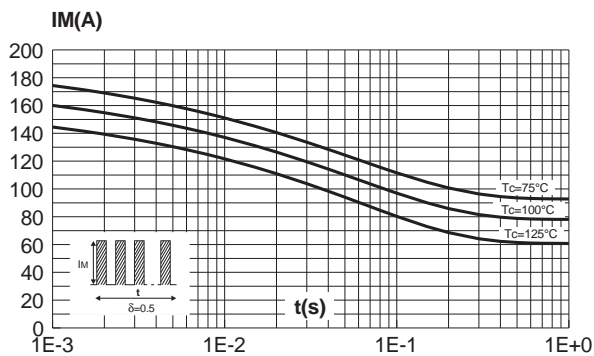
**Fig. 1:** Average forward power dissipation versus average forward current.



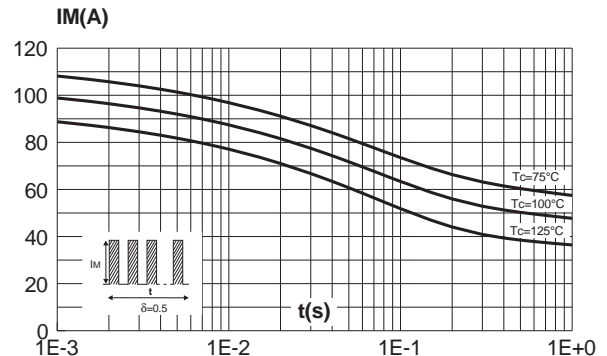
**Fig. 2:** Average current versus ambient temperature ( $\delta : 0.5$ ).



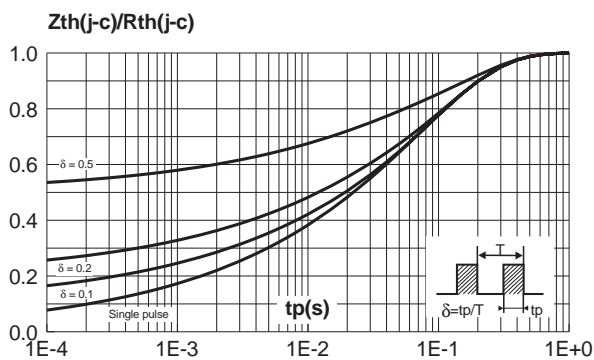
**Fig. 3-1:** Non repetitive surge peak forward current versus overload duration (maximum values) (TO-220AC).



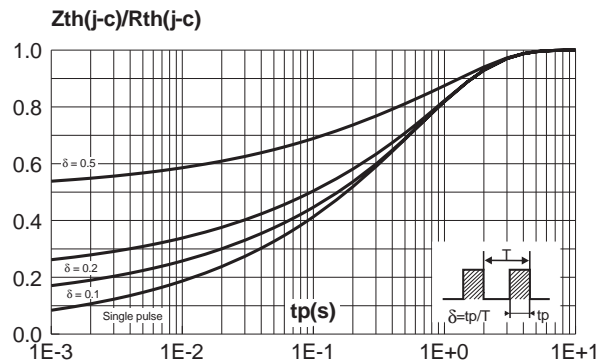
**Fig. 3-2:** Non repetitive surge peak forward current versus overload duration (maximum values) (ISOWATT220AC).



**Fig. 4-1:** Relative variation of thermal transient impedance junction to case versus pulse duration (TO-220AC).

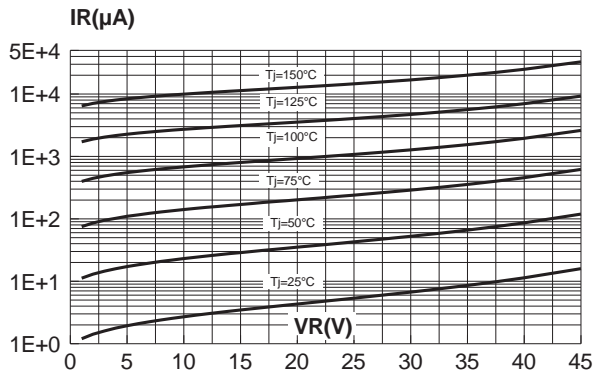


**Fig. 4-2:** Relative variation of thermal transient impedance junction to case versus pulse duration (ISOWATT220AC).

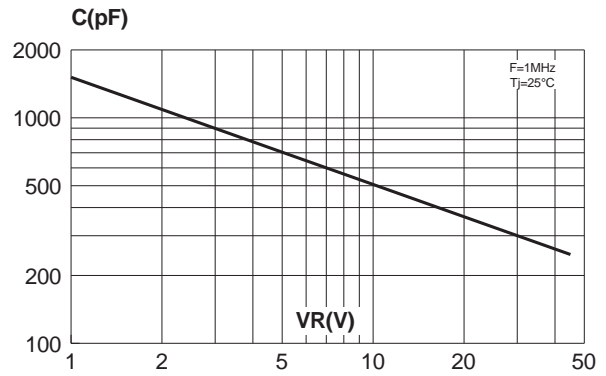


## STPS1545D/F

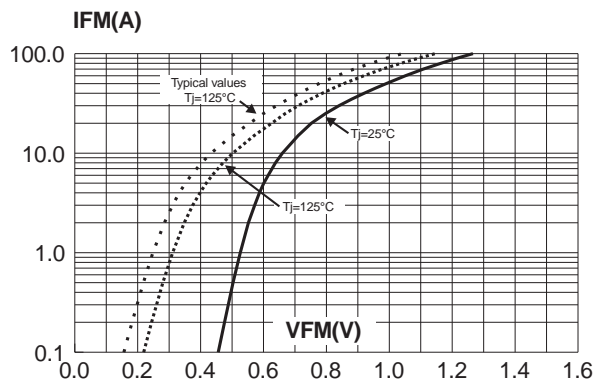
**Fig. 5:** Reverse leakage current versus reverse voltage applied (typical values).



**Fig. 6:** Junction capacitance versus reverse voltage applied (typical values).

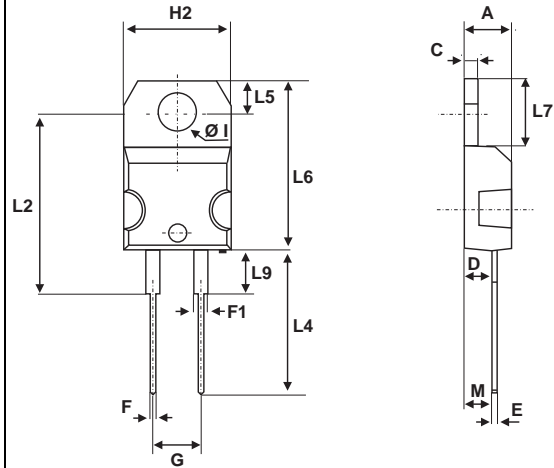


**Fig. 7:** Forward voltage drop versus forward current (maximum values).



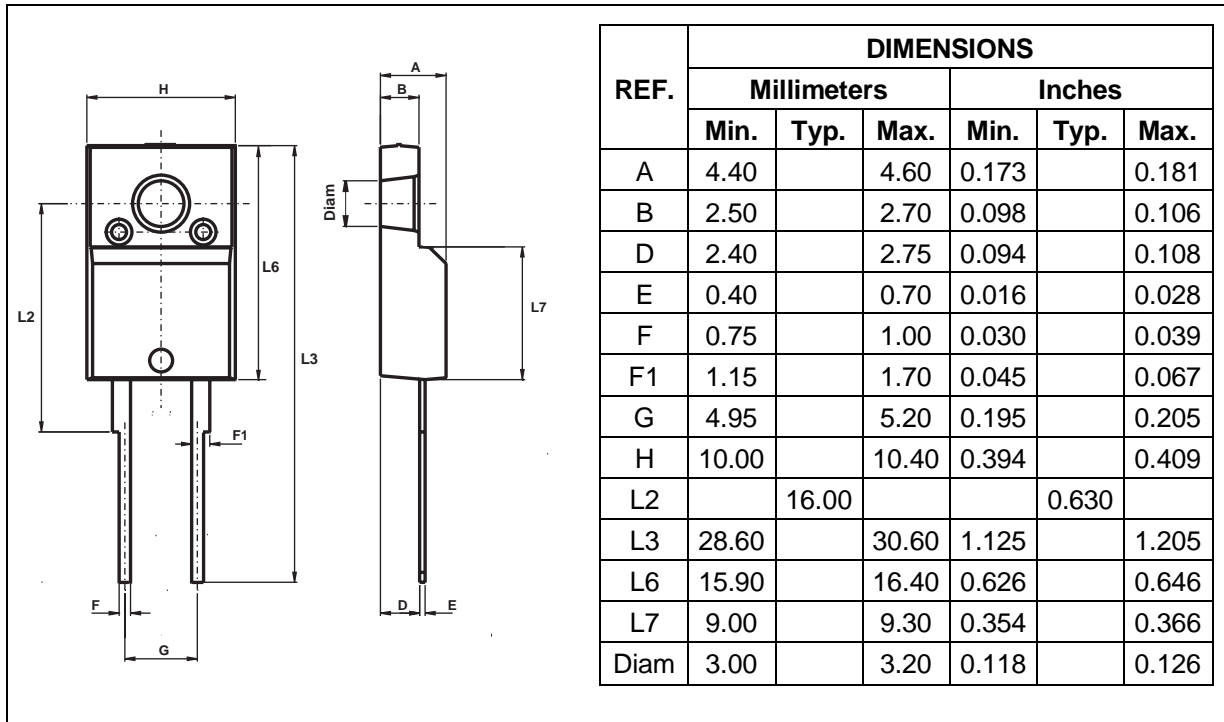
**PACKAGE MECHANICAL DATA**  
 TO-220AC

REF.	DIMENSIONS			
	Millimeters		Inches	
	Min.	Max.	Min.	Max.
A	4.40	4.60	0.173	0.181
C	1.23	1.32	0.048	0.051
D	2.40	2.72	0.094	0.107
E	0.49	0.70	0.019	0.027
F	0.61	0.88	0.024	0.034
F1	1.14	1.70	0.044	0.066
G	4.95	5.15	0.194	0.202
H2	10.00	10.40	0.393	0.409
L2	16.40 typ.		0.645 typ.	
L4	13.00	14.00	0.511	0.551
L5	2.65	2.95	0.104	0.116
L6	15.25	15.75	0.600	0.620
L7	6.20	6.60	0.244	0.259
L9	3.50	3.93	0.137	0.154
M	2.6 typ.		0.102 typ.	
Diam. I	3.75	3.85	0.147	0.151



# STPS1545D/F

## PACKAGE MECHANICAL DATA ISOWATT220AC



Type	Marking	Package	Weight	Base qty	Delivery mode
STPS1545D	STPS1545D	TO-220AC	1.86 g.	50	Tube
STPS1545F	STPS1545F	ISOWATT220AC	2.9 g.	50	Tube

- Cooling method: by conduction (C)
- Recommended torque value: 0.55 N.m.
- Maximum torque value: 0.7 N.m.
- Epoxy meets UL94,V0

Information furnished is believed to be accurate and reliable. However, STMicroelectronics assumes no responsibility for the consequences of use of such information nor for any infringement of patents or other rights of third parties which may result from its use. No license is granted by implication or otherwise under any patent or patent rights of STMicroelectronics. Specifications mentioned in this publication are subject to change without notice. This publication supersedes and replaces all information previously supplied. STMicroelectronics products are not authorized for use as critical components in life support devices or systems without express written approval of STMicroelectronics.

The ST logo is a registered trademark of STMicroelectronics

© 1999 STMicroelectronics - Printed in Italy - All rights reserved.

STMicroelectronics GROUP OF COMPANIES

Australia - Brazil - China - Finland - France - Germany - Hong Kong - India - Italy - Japan - Malaysia  
Malta - Morocco - Singapore - Spain - Sweden - Switzerland - United Kingdom - U.S.A.

<http://www.st.com>