

PRODUCT SPECIFICATION

COSMO ELECTRONICS CO., LTD.	PHOTO MOS RELAYS: KAQV210	SHEET 1 OF 7
---------------------------------------	-------------------------------------	--------------

• **OUTSIDE DIMENSION :**

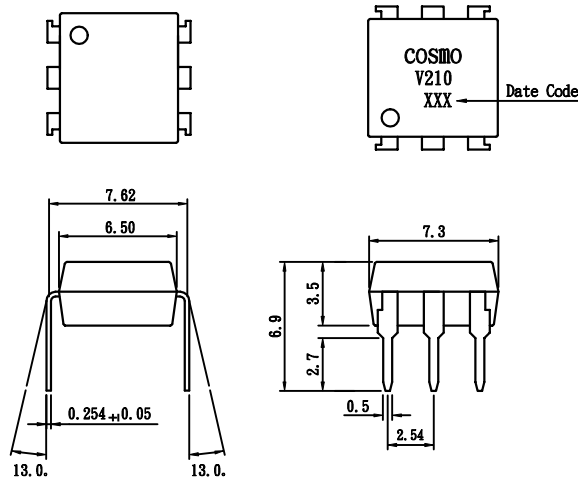

Unit:mm
Tolerance: +0.2 mm

• **Turn on/Turn off time**

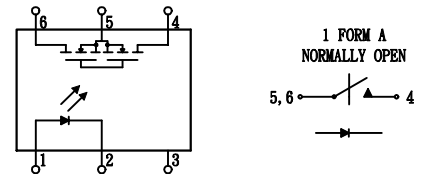
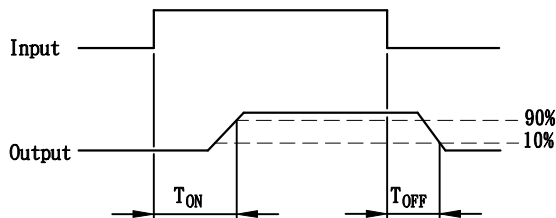

Absolute Maximum Ratings ($T_A=25. C$)

Emitter (Input)

- Reverse Voltage 5.0V
- Continuous Forward Current 50mA
- Peak Forward Current (1s) 1A
- Power Dissipation. 100mW
- Derate Linearly from 25. C 1.3mW/. C

Detector (Output)

- Output Breakdown Voltage +350V
- Continous Load Current +130mA
- Power Dissipation 500mW

General Characteristics

- Isolation Test Voltage. 3750VAC_{RMS}
- Isolation Resistance
- $V_{10}=500V, T_A=25. C \geq 10^{10} \Omega$
- Total Power Dissipation 550mW

- Derate Linearly form 25. C 2.5mW/. C
- Storage Temperature Range -40 to +150. C
- Operating Temperature Range. . . . -40 to +85. C
- Junction Temperature 100. C
- Soldering Temperature, 2mm from case, 10 sec. 260. C

PRODUCT SPECIFICATION

COSMO ELECTRONICS CO., LTD.	PHOTO MOS RELAYS: KAQV210	SHEET 2 OF 7
---------------------------------------	-------------------------------------	--------------

Characteristics

(T_A = 25° C)

Description	Symbol	Min.	Typ.	Max.	Unit	Test Condition
Emitter (Input)						
Forward Voltage	V _F		1.8	2.0	V	I _F = 10mA
Operation Input Current	I _{FON}			5	mA	V _L = ± 20V, I _L = 100mA, t = 10 ms
Recovery Input Current	I _{FOFF}	0.2			mA	V _L = ± 20V, I _L = <5uA
Detector (Output)						
Output Breakdown Voltage	V _B	350			V	I _B = 50uA
Output Off-State Leakage	I _{T(OFF)}		0.2	1	uA	V _T = 100V, I _F = 0mA
I/O Capacitance	C _{ISO}		6		pF	I _F = 0, f = 1MHz
ON Resistance	Connection	A	20	30	Ω	I _L = 100mA, I _F = 10mA
		B	10	15		
		C	5	7.5		
Turn-on Time	T _{ON}		0.3	1.0	ms	I _F = 10mA, V _L = ± 20V
Turn-off Time	T _{OFF}		0.7	1.5	ms	t = 10ms, I _L = ± 100mA

Mos Relay Schematic and Wiring Diagrams

Type	Schematic	Output configuration	Load	Con-nection	Wiring diagram
KAQV210		1a	AC/DC	A	
			DC	B	
DC	C				

PRODUCT SPECIFICATION

<p>COSMO ELECTRONICS CO., LTD.</p>	<p>PHOTO MOS RELAYS: KAQV210</p>	<p>SHEET 3 OF 7</p>
---	---	---------------------

DATA CURVE

Load current vs. ambient temperature
Allowable ambient temperature:
-40° C+85° C

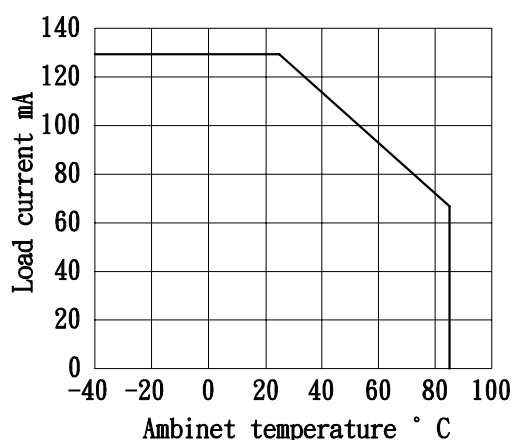

On resistance vs. ambient temperature
Across terminals 4 and 6 pin
LED current: 5mA
Continuous load current: 130 mA(DC)

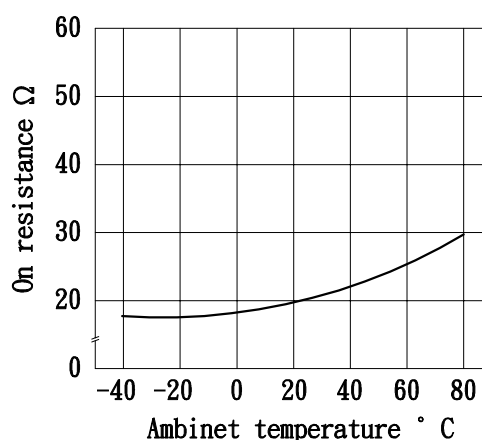

Turn on time vs. ambient temperature
Load voltage 350 V(DC)
LED current :5mA
Continuous load current: 130mA(DC)

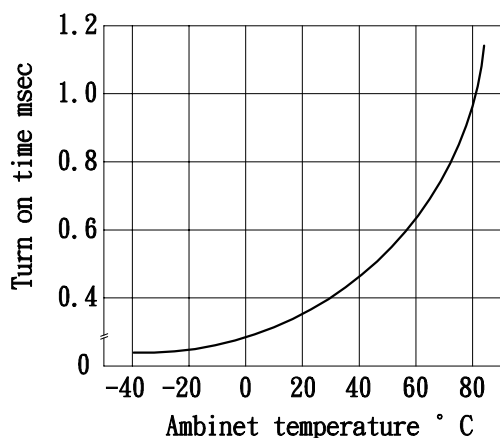

Turn off time vs. ambient temperature
LED current: 5mA; Load voltage: 350V(DC)
Continuous load current: 130mA(DC)

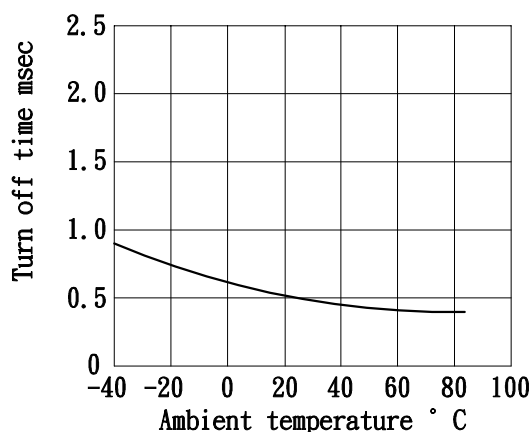

PRODUCT SPECIFICATION

<p>COSMO ELECTRONICS CO., LTD.</p>	<p>PHOTO MOS RELAYS: KAQV210</p>	<p>SHEET 4 OF 7</p>
---	---	---------------------

LED operate vs. ambient temperature
Load voltage: 350V(DC)
Continuous load current: 130mA(DC)

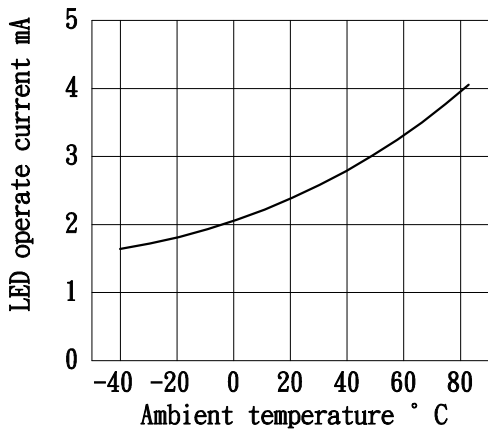

LED turn off current vs. ambient temperature
Load voltage: 350V(DC)
Continuons load current: 130mA(DC)

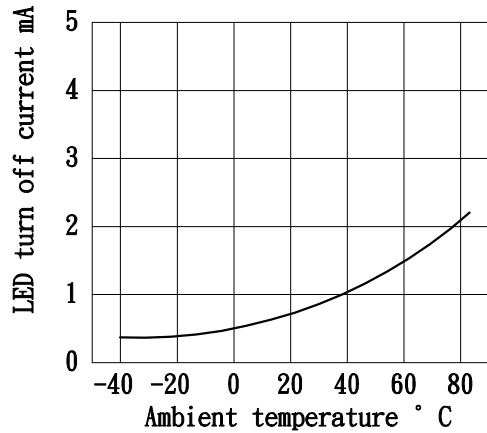

LED dropout voltage vs. ambient temperature
LED current: 5 to 50mA

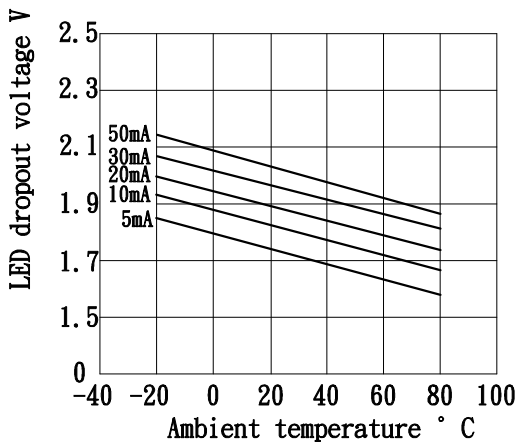

Voltage vs. current characteristics of output at MOS FET portion
Measured portion: across terminals 4 and 6 pin
Ambient temperature: 25° C

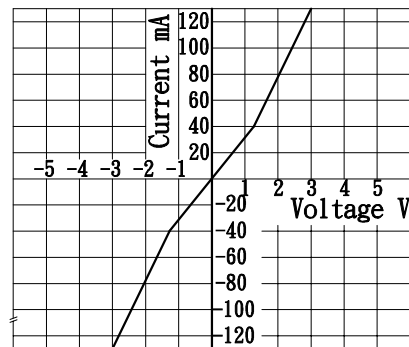

PRODUCT SPECIFICATION

COSMO

ELECTRONICS CO., LTD.

PHOTO MOS RELAYS:

KAQV210

SHEET 5 OF 7

LED forward current vs. turn on time
Across terminals 4 and 6pin; Load voltage: 350V(DC); Continuous load current: 130mA(DC); Ambient temperature: 25° C

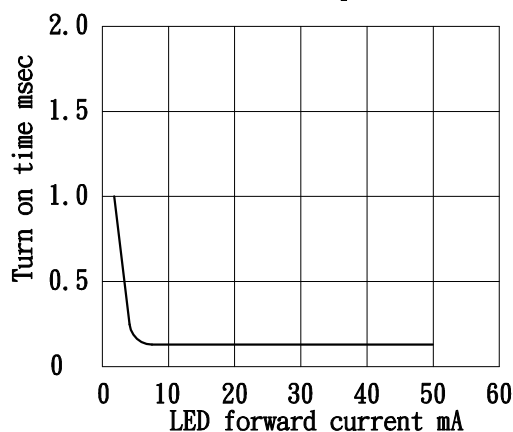

Off state leakage current
Across terminals 4 and 6pin
Ambient temperature: 25° C

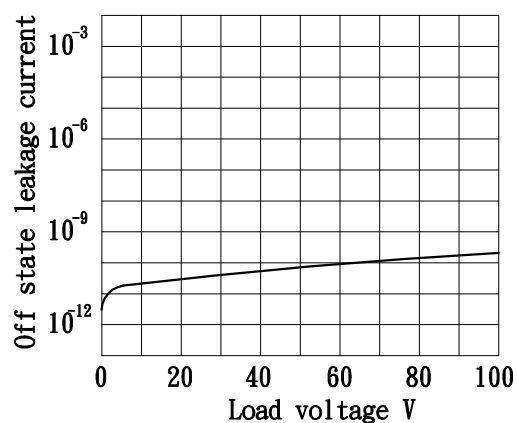

LED forward current vs. turn off time
Across terminals 4 and 6pin; Load voltage: 350V(DC); Continuous load current: 130 mA(DC); Ambient temperature: 25° C

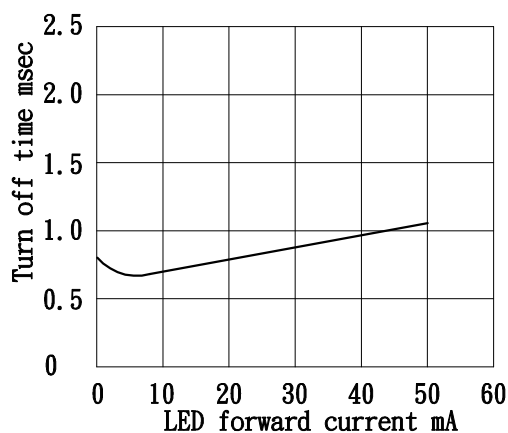

Applied voltage vs. output capacitance
Across terminals 4 and 6pin
Frequency: 1MHz; Ambient temperature: 25° C

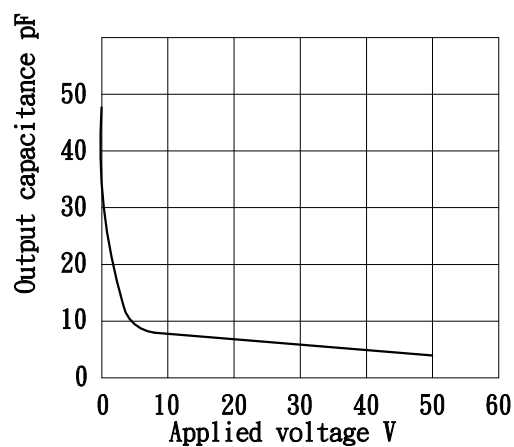

PRODUCT SPECIFICATION

COSMO ELECTRONICS CO., LTD.	PHOTO MOS RELAYS: KAQV210	SHEET 6 OF 7
---------------------------------------	-------------------------------------	--------------

USING METHODS

Examples of resistance value to control LED forward current I_F

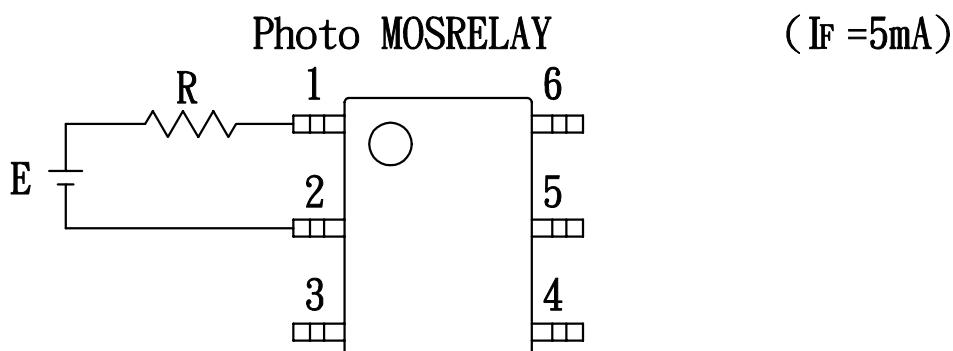

E	R
3.3V	Approx. 240 ohm
5V	Approx. 540 ohm
12V	Approx. 1.8K ohm
15V	Approx. 2.4K ohm
24V	Approx. 4K ohm

- (1) LED forward current must be more than 5mA, at E min.
- (2) LED forward current must be less than 50mA, at E max.

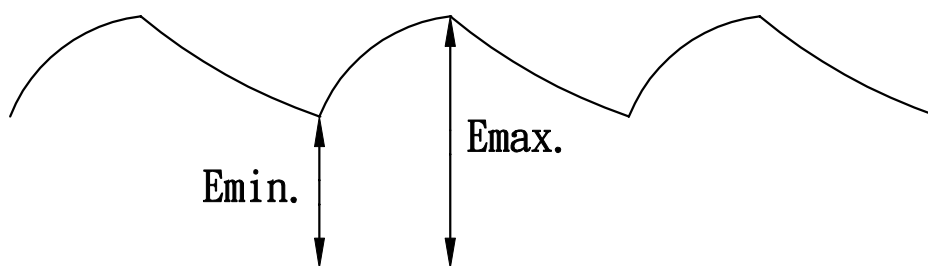

PRODUCT SPECIFICATION

COSMO ELECTRONICS CO., LTD.	PHOTO MOS RELAYS: KAQV210	SHEET 7 OF 7
---------------------------------------	-------------------------------------	--------------

USING METHODS

Regulate the spike voltage generated on the inductive load as follows

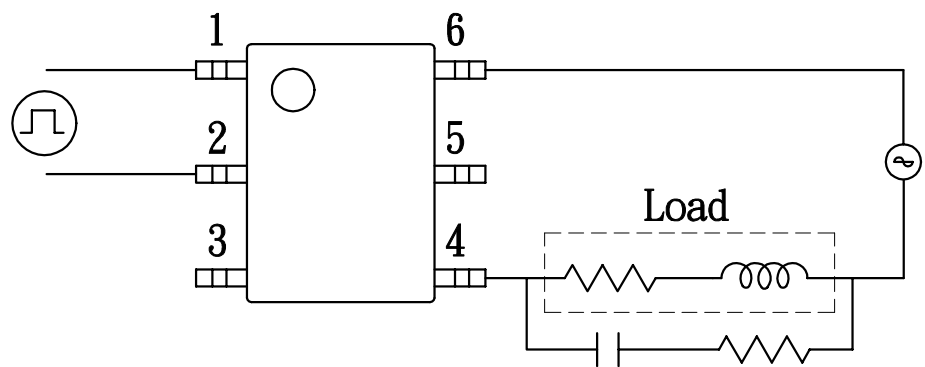
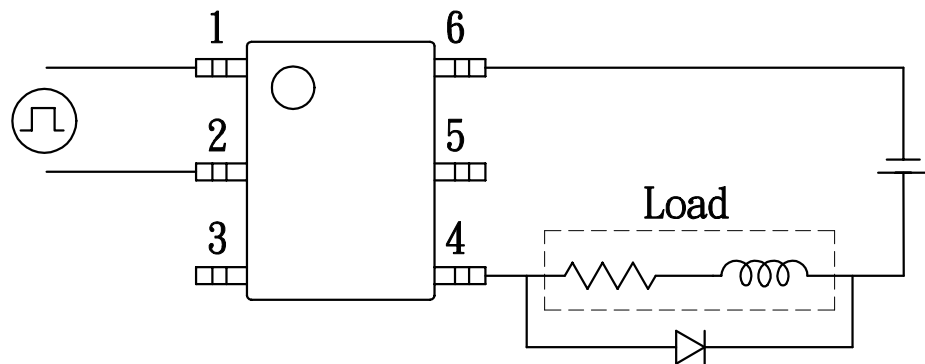

R-C Snubber