



CEP4060A/CEB4060A

March 1998

N-Channel Enhancement Mode Field Effect Transistor

4

FEATURES

- 60V , 15A , $R_{DS(ON)}=85m\Omega$ @ $V_{GS}=10V$.
- Super high dense cell design for extremely low $R_{DS(ON)}$.
- High power and current handling capability.
- TO-220 & TO-263 package.

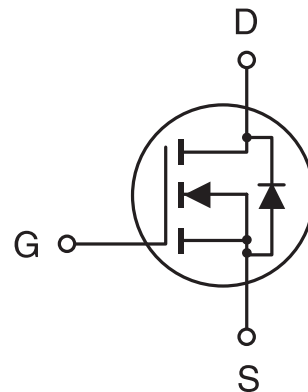

ABSOLUTE MAXIMUM RATINGS ($T_c=25^\circ C$ unless otherwise noted)

Parameter	Symbol	Limit	Unit
Drain-Source Voltage	V_{DS}	60	V
Gate-Source Voltage	V_{GS}	± 20	V
Drain Current-Continuous -Pulsed	I_D	15	A
	I_{DM}	45	A
Drain-Source Diode Forward Current	I_S	15	A
Maximum Power Dissipation @ $T_c=25^\circ C$ Derate above $25^\circ C$	P_D	50	W
		0.35	W/ $^\circ C$
Operating and Storage Temperature Range	T_J, T_{STG}	-65 to 175	$^\circ C$

THERMAL CHARACTERISTICS

Thermal Resistance, Junction-to-Case	$R_{\theta JC}$	3	$^\circ C/W$
Thermal Resistance, Junction-to-Ambient	$R_{\theta JA}$	62.5	$^\circ C/W$

CEP4060A/CEB4060A

4

ELECTRICAL CHARACTERISTICS (Tc=25°C unless otherwise noted)

Parameter	Symbol	Condition	Min	Typ	Max	Unit
OFF CHARACTERISTICS						
Drain-Source Breakdown Voltage	BV _{DSS}	V _{GS} =0V, I _D =250μA	60			V
Zero Gate Voltage Drain Current	I _{DSS}	V _{DS} =60V, V _{GS} =0V			25	μA
Gate-Body Leakage	I _{GSS}	V _{GS} =±20V, V _{DS} =0V			±100	nA
ON CHARACTERISTICS^a						
Gate Threshold Voltage	V _{GS(th)}	V _{DS} =V _{GS} , I _D =250μA	2	2.8	4	V
Drain-Source On-State Resistance	R _{DS(ON)}	V _{GS} =10V, I _D =7.5A		66	85	mΩ
On-State Drain Current	I _{D(ON)}	V _{GS} =10V, V _{DS} =10V	15			A
Forward Transconductance	g _{FS}	V _{DS} =10V, I _D =7.5A		6		S
DYNAMIC CHARACTERISTICS^b						
Input Capacitance	C _{ISS}	V _{DS} =25V, V _{GS} =0V f=1.0MHz		292	400	pF
Output Capacitance	C _{OSS}			130	200	pF
Reverse Transfer Capacitance	C _{RSS}			36	50	pF
SWITCHING CHARACTERISTICS^b						
Turn-On Delay Time	t _{D(ON)}	V _{DD} =30V, I _D =15A, V _{GS} =10V, V _{GEN} =25Ω		7	20	ns
Rise Time	t _r			65	100	ns
Turn-Off Delay Time	t _{D(OFF)}			15	30	ns
Fall Time	t _f			35	50	ns
Total Gate Charge	Q _g	V _{DS} =48V, I _D =15A, V _{GS} =10V		9	17	nC
Gate-Source Charge	Q _{gs}			2		nC
Gate-Drain Charge	Q _{gd}			4		nC

CEP4060A/CEB4060A

ELECTRICAL CHARACTERISTICS ($T_c=25^\circ\text{C}$ unless otherwise noted)

Parameter	Symbol	Condition	Min	Typ	Max	Unit
DRAIN-SOURCE DIODE CHARACTERISTICS^b						
Diode Forward Voltage	V_{SD}	$V_{GS} = 0V, I_S = 7.5A$		0.8	1.3	V

Notes

a. Pulse Test: Pulse Width $\leq 300 \mu s$, Duty Cycle $\leq 2\%$.

b. Guaranteed by design, not subject to production testing.

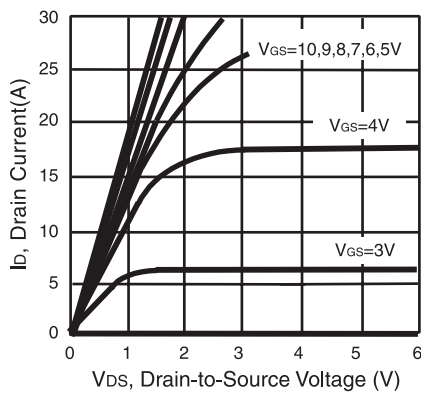

Figure 1. Output Characteristics

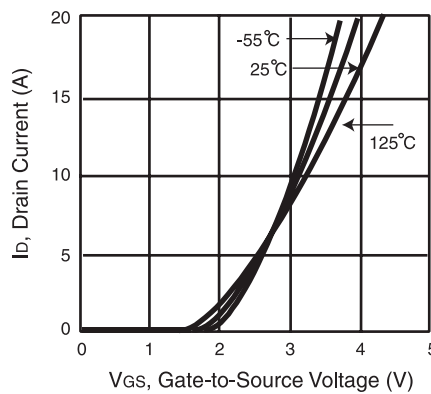

Figure 2. Transfer Characteristics

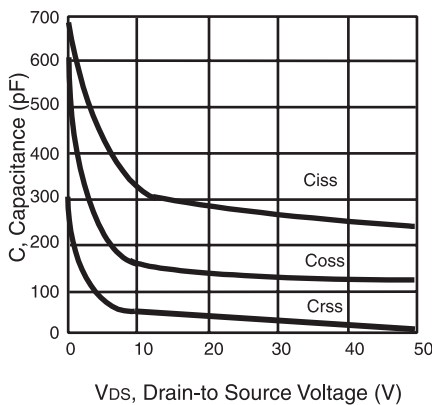

Figure 3. Capacitance

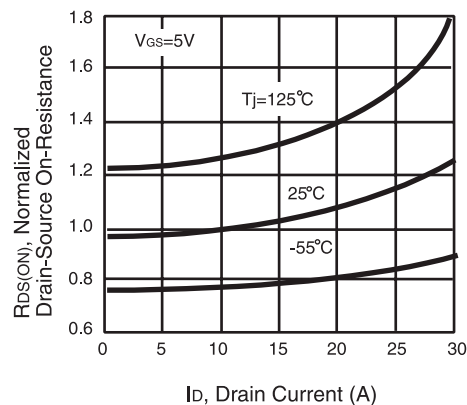

Figure 4. On-Resistance Variation with Drain Current and Temperature

CEP4060A/CEB4060A

4

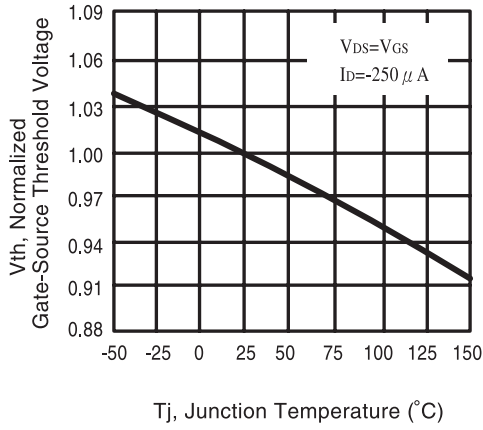

Figure 5. Gate Threshold Variation with Temperature

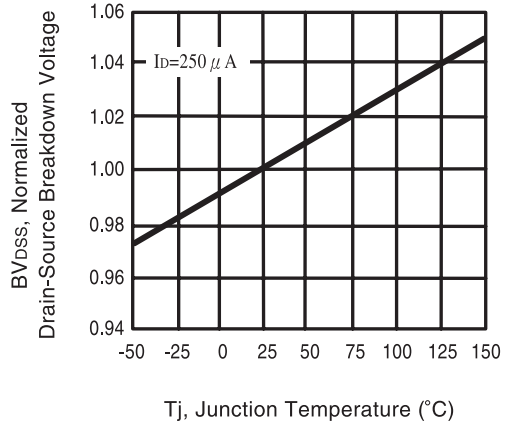

Figure 6. Breakdown Voltage Variation with Temperature

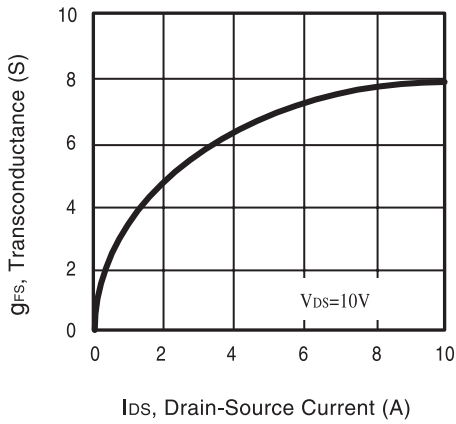

Figure 7. Transconductance Variation with Drain Current

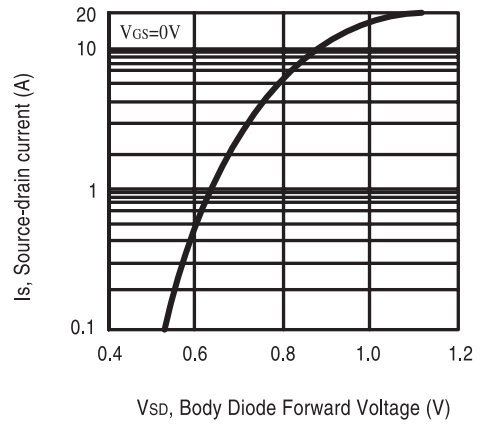

Figure 8. Body Diode Forward Voltage Variation with Source Current

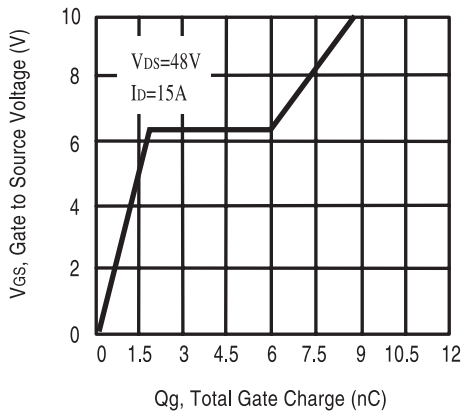

Figure 9. Gate Charge

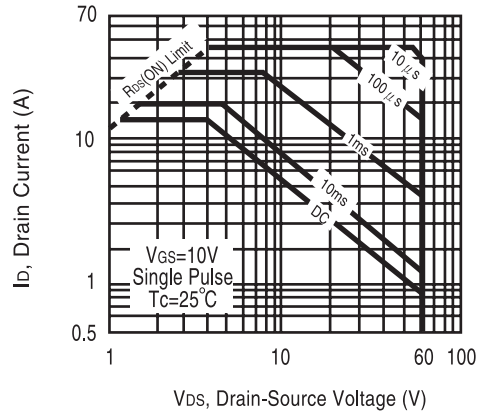

Figure 10. Maximum Safe Operating Area

CEP4060A/CEB4060A

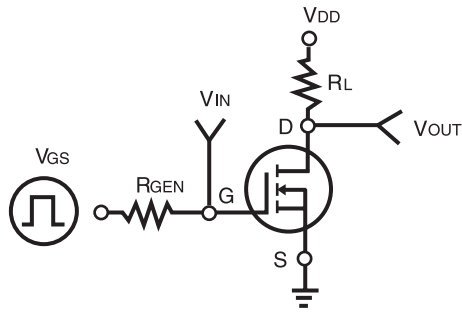

Figure 11. Switching Test Circuit

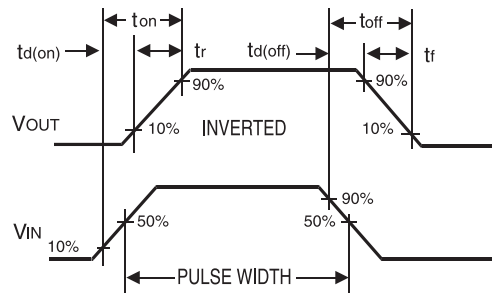

Figure 12. Switching Waveforms

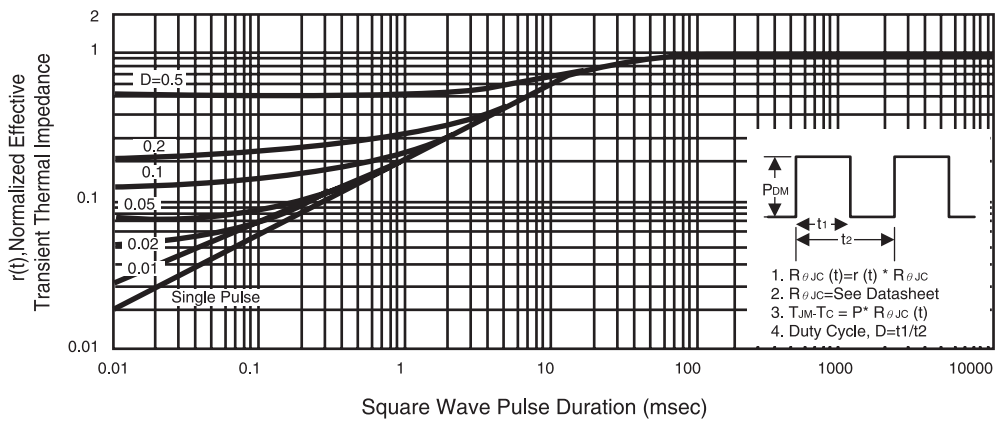

Figure 13. Normalized Thermal Transient Impedance Curve