

TOSHIBA PHOTO TRANSISTOR SILICON NPN EPITAXIAL PLANAR

TPS610

FOR PHOTO SENSOR

Unit in mm

PHOTOELECTRIC COUNTER
 VARIOUS KINDS OF READERS
 POSITION DETECTION

- $\phi 5$ mm epoxy resin package
- High sensitivity : $I_L = 250\mu A$ (TYP.)
- Half value angle : $\theta_{\frac{1}{2}} = \pm 8^\circ$ (TYP.)
- The TLN110 in the same size and TLN205 in the similar external size are available as infrared LEDs.

MAXIMUM RATINGS ($T_a = 25^\circ C$)

CHARACTERISTIC	SYMBOL	RATING	UNIT
Collector-Emitter Voltage	V_{CEO}	30	V
Emitter-Collector Voltage	V_{ECO}	5	V
Collector Current	I_C	50	mA
Collector Power Dissipation	P_C	150	mW
Collector Power Dissipation Derating ($T_a > 25^\circ C$)	$\Delta P_C / ^\circ C$	-2	mW / $^\circ C$
Operating Temperature Range	T_{opr}	-20~75	$^\circ C$
Storage Temperature Range	T_{stg}	-30~100	$^\circ C$

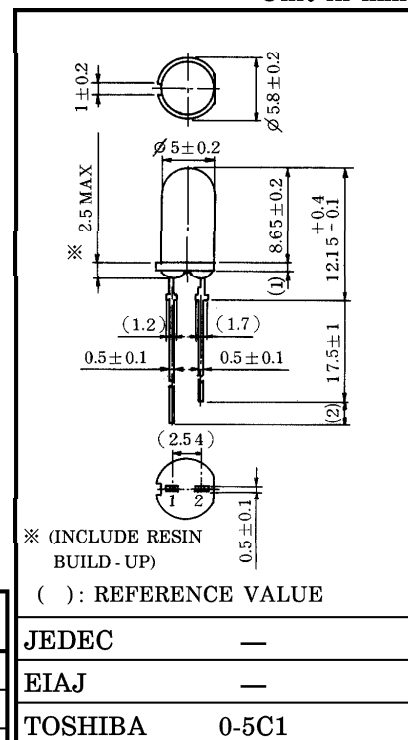

Weight : 0.3g (TYP.)

PIN CONNECTION

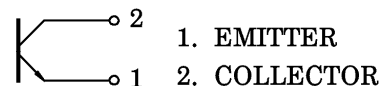

OPTO-ELECTRICAL CHARACTERISTICS ($T_a = 25^\circ C$)

CHARACTERISTIC	SYMBOL	TEST CONDITION	MIN.	TYP.	MAX.	UNIT
Dark Current	$I_D (I_{CEO})$	$V_{CE} = 24V, E = 0$	—	0.005	0.1	μA
Light Current	I_L	$V_{CE} = 3V, E = 0.1mW/cm^2$ (Note)	100	250	—	μA
Collector-Emitter Saturation Voltage	$V_{CE(sat)}$	$I_C = 50\mu A, E = 0.1mW/cm^2$ (Note)	—	0.25	0.4	V
Switching Time	Rise Time	$V_{CC} = 5V, I_C = 2mA$ $R_L = 100\Omega$	—	6	—	μs
	Fall Time		—	6	—	
Peak Sensitivity Wavelength	λ_P	—	—	800	—	nm
Half Value Angle	$\theta_{\frac{1}{2}}$	—	—	± 8	—	$^\circ$

(Note) Color temperature = 2870°K, Standard Tungsten Lamp

961001EAA2

● TOSHIBA is continually working to improve the quality and the reliability of its products. Nevertheless, semiconductor devices in general can malfunction or fail due to their inherent electrical sensitivity and vulnerability to physical stress. It is the responsibility of the buyer, when utilizing TOSHIBA products, to observe standards of safety, and to avoid situations in which a malfunction or failure of a TOSHIBA product could cause loss of human life, bodily injury or damage to property. In developing your designs, please ensure that TOSHIBA products are used within specified operating ranges as set forth in the most recent products specifications. Also, please keep in mind the precautions and conditions set forth in the TOSHIBA Semiconductor Reliability Handbook.

PRECAUTION

Please be careful of the followings.

1. Soldering shall be performed at the top portion from the lead stopper.
2. Soldering temperature : 260°C MAX. Soldering time : 5s MAX.
3. When the lead is formed, the lead shall be formed at the top portion of the stopper without leaving forming stress to the body of the device. Soldering shall be performed after lead forming.

961001EAA2'

- The information contained herein is presented only as a guide for the applications of our products. No responsibility is assumed by TOSHIBA CORPORATION for any infringements of intellectual property or other rights of the third parties which may result from its use. No license is granted by implication or otherwise under any intellectual property or other rights of TOSHIBA CORPORATION or others.
- The information contained herein is subject to change without notice.

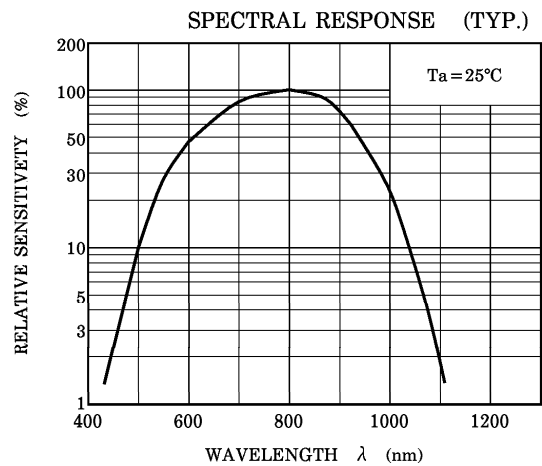
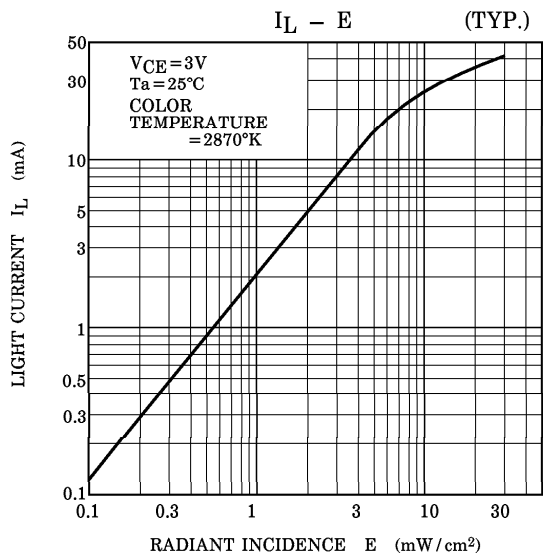
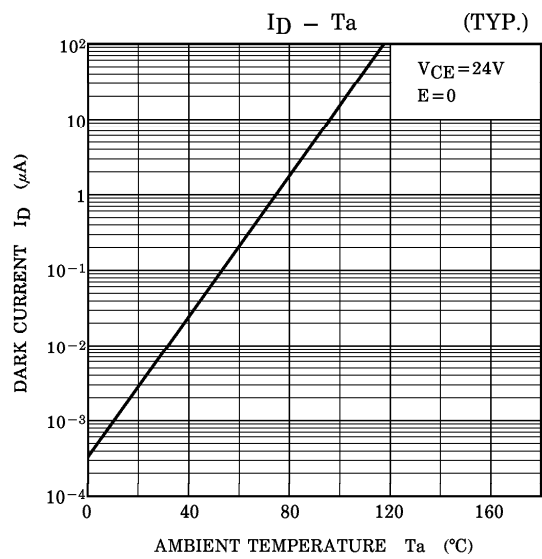
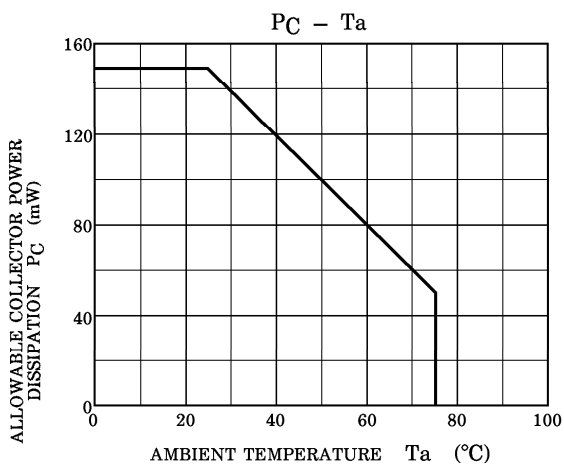
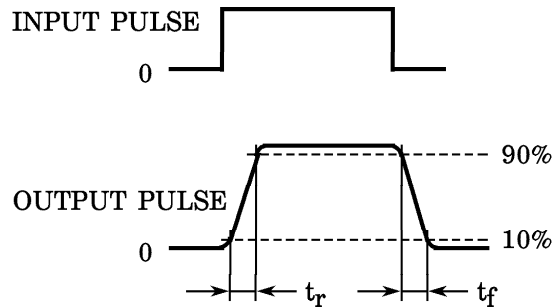
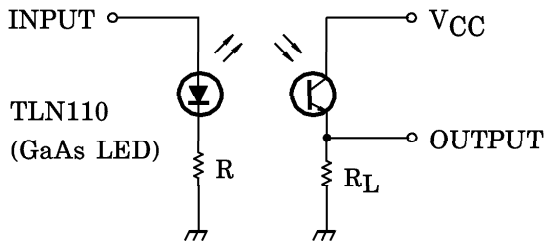

DIRECTIONAL SENSITIVITY CHARACTERISTIC (TYP.)
($T_a = 25^\circ\text{C}$)

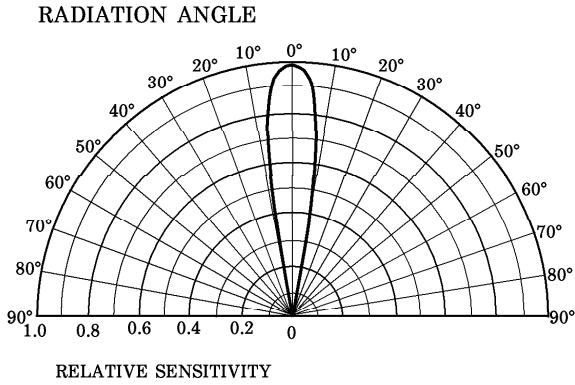

FREQUENCY CHARACTERISTICS (TYP.)

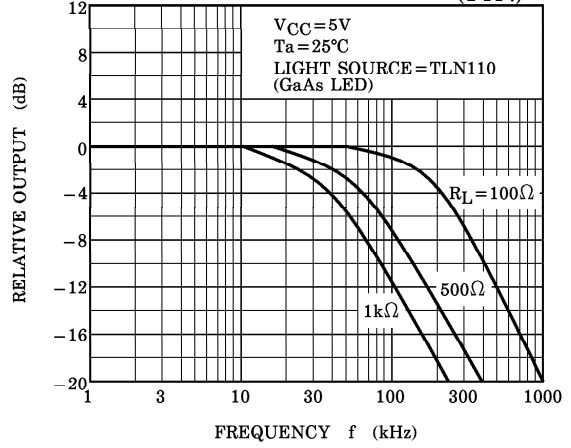

SWITCHING CHARACTERISTICS (TYP.)

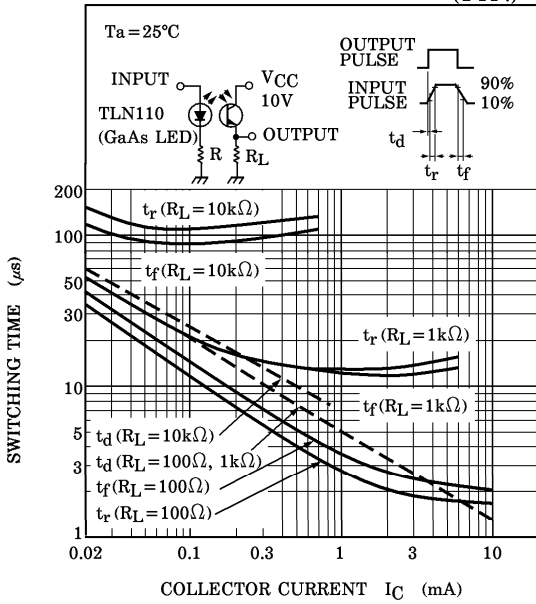

COUPLING CHARACTERISTICS WITH TLN110

