

HW-105A

- High-sensitivity InSb Hall element.
- Super mini-mold SMT package (fits SOT343 land pattern).
- Shipped in packet-tape reel (5000pcs per reel).

Note : It is requested to read and accept "IMPORTANT NOTICE".

•Absolute Maximum Ratings

| Item | Symbol | | Limit | Unit |
|-----------------------|------------|----------------------|-------------|------|
| Max. Input Current | I_c | Const. Current Drive | 20 | mA |
| Operating Temp. Range | $T_{opr.}$ | | -40 to +110 | °C |
| Storage Temp. Range | $T_{stg.}$ | | -40 to +125 | °C |

Please be aware that AKE products are not intended for use in life support equipment, devices, or systems. Use of AKE products in such applications requires the advance written approval of the appropriate AKE officer.

Certain applications using semiconductor devices may involve potential risks of personal injury, property damage, or loss of life. In order to minimize these risks, adequate design and operating safeguards should be provided by the customer to minimize inherent or procedural hazards. Inclusion of AKE products in such applications is understood to be fully at the risk of the customer using AKE devices or systems.



•Electrical Characteristics($T_a=25^\circ\text{C}$)

| Item | Symbol | Conditions | Min. | Typ. | Max. | Unit |
|-------------------------------|-----------------|--|------|------|------|------------|
| Output Hall Voltage | V_H | Const. Voltage Drive $B=50\text{mT}$, $V_C=IV$ | 122 | | 274 | mV |
| Input Resistance | R_{in} | $B=0\text{mT}$, $I_C=0.1\text{mA}$ | 250 | | 450 | Ω |
| Output Resistance | R_{out} | $B=0\text{mT}$, $I_C=0.1\text{mA}$ | 250 | | 450 | Ω |
| Offset Voltage | V_{OS} | $B=0\text{mT}$, $V_C=IV$ | -12 | | +12 | mV |
| Temp. Coefficient of V_H | αV_H | $B=50\text{mT}$, $I_C=5\text{mA}$ | | -1.8 | | %/°C |
| Temp. Coefficient of R_{in} | αR_{in} | $B=0\text{mT}$, $I_C=0.1\text{mA}$ | | -1.8 | | %/°C |
| Dielectric Strength | | 100V D.C | 1.0 | | | M Ω |

Notes : 1. $V_H = V_{HM} - V_{OS}$ (VHM:meter indication)

$$2. \alpha V_H = \frac{1}{V_H(T_1)} \times \frac{V_H(T_3) - V_H(T_2)}{(T_3 - T_2)} \times 100$$

$$3. \alpha R_{in} = \frac{1}{R_{in}(T_1)} \times \frac{R_{in}(T_3) - R_{in}(T_2)}{(T_3 - T_2)} \times 100$$

$$T_1 = 20^\circ\text{C}, T_2 = 0^\circ\text{C}, T_3 = 40^\circ\text{C}$$

•Dimensional Drawing (mm)

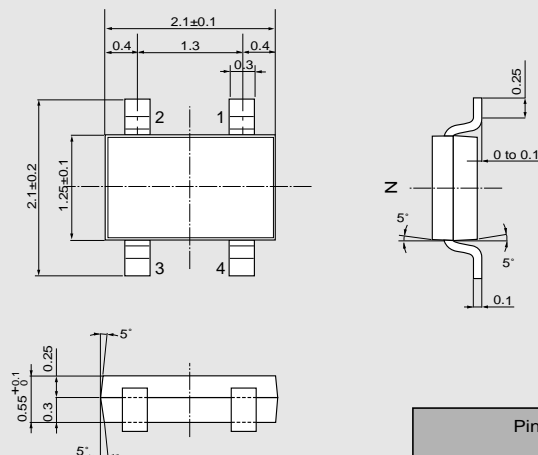

| Pinning | | |
|---------|------|------|
| Input | 1(±) | 3(∓) |
| Output | 2(±) | 4(∓) |

•Classification of Output Hall Voltage (V_H)

| Rank | V_H [mV] | Conditions |
|------|--------------|--|
| A | 122 to 150 | $B=50\text{mT}$, $V_C=IV$ Constant Voltage Drive |
| B | 144 to 174 | |
| C | 168 to 204 | |
| D | 196 to 236 | |
| E | 228 to 274 | |

Note : When ordering, specify 3-rank or wider range(e.g.,BCD).

•Input Current Derating Curve

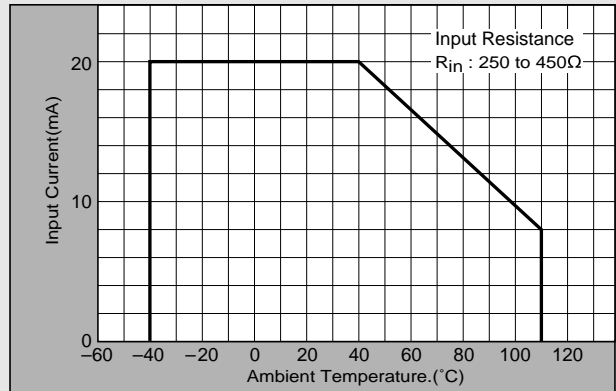

Note : R_{in} of Hall element decreases rapidly as ambient temperature increases. Ensure compliance with input current derating curve envelope, throughout the operating temperature range.

•Input Voltage Derating Curve

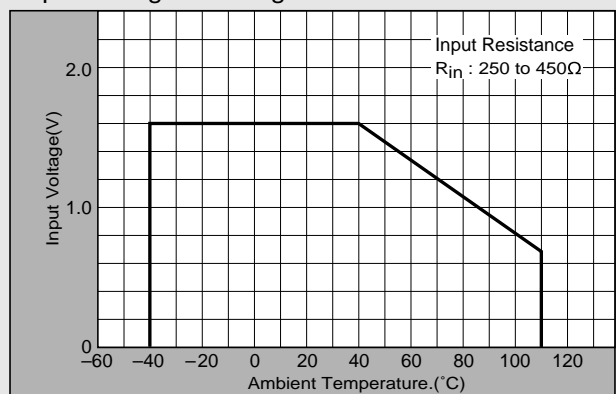

Note : For constant-voltage drive, stay within this input voltage derating curve envelope.

•Characteristic Curves

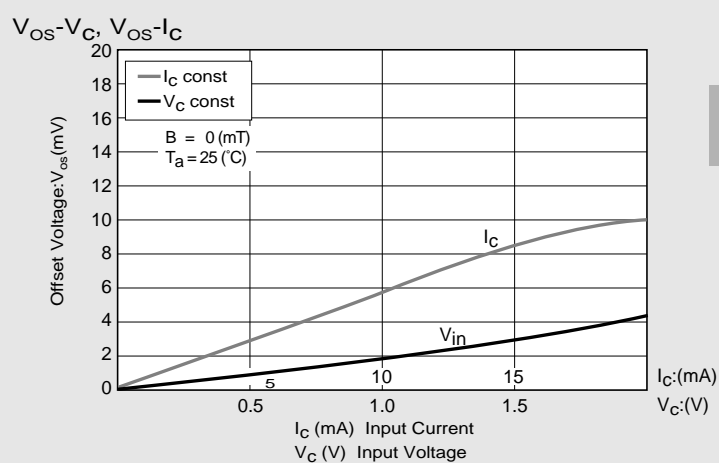
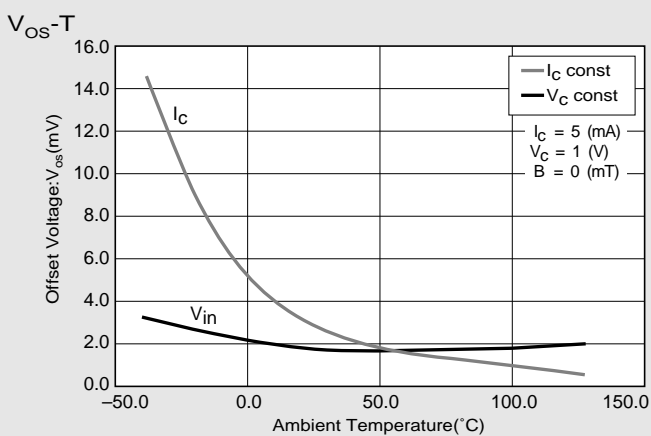
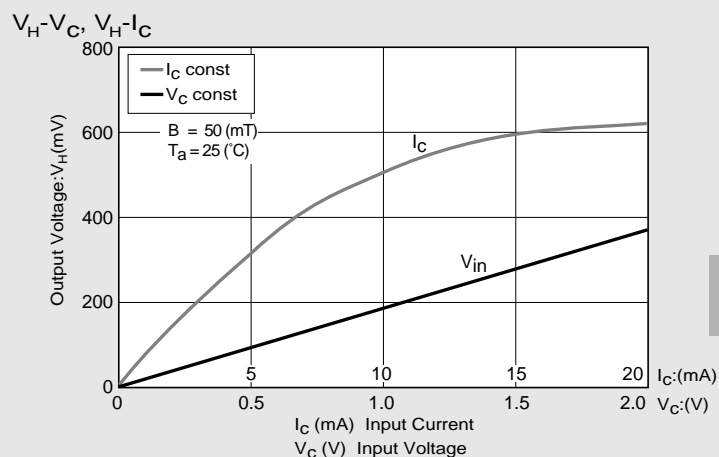
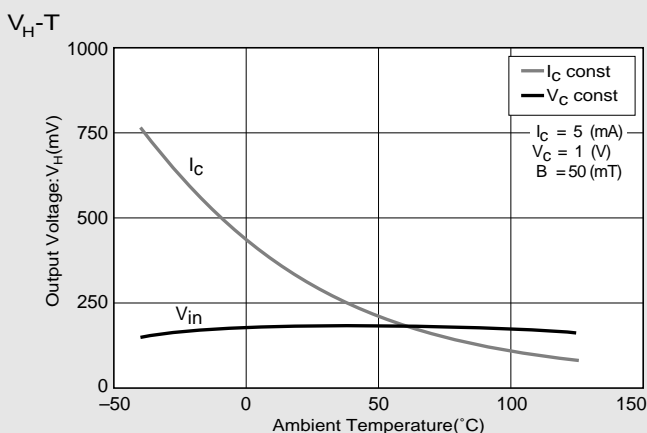
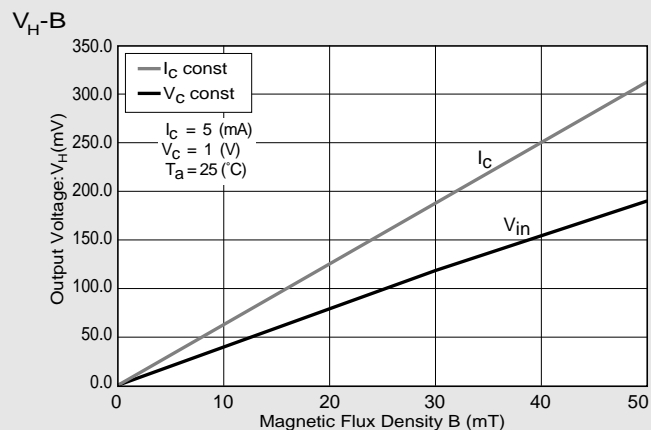
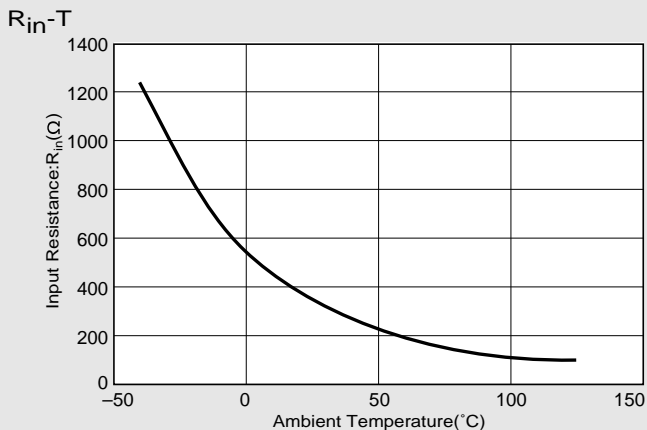

*Magnetic Flux Density
1(mT)=10(G)

In This Example : $R_{in}=350(\Omega)$, $V_{OS}=1.9(mV)$, $V_C=1(V)$