



demo board for SP6128A, a synchronous buck controller

***Non-Isolated DC-DC SIP Modules:
3.0Vdc-5.5Vdc In, 0.9Vdc-3.3Vdc out, 10A***

FEATURES:

- High Efficiency: 94.5% at 3.3V output,10A
- Small size and very low profile
43.2mm × 7.25mm × 13.97mm
(1.7in × 0.285in × 0.55in)
- 3V to 5.5V input voltage
- All ceramic capacitors design
- Negative or Positive remote On/Off
- Thermal shut down protection
- Low output ripple max 20mV
- Output voltage adjustable with the trim function
- Low EMI noise
- Short circuit and over current protection using Hiccup mode and auto-restart
- Build in UVLO function
- Wide operation temperature range
-40°C to +85°C
- ± 0.1% line regulation & ± 0.3% load regulation
-40°C to +85°C

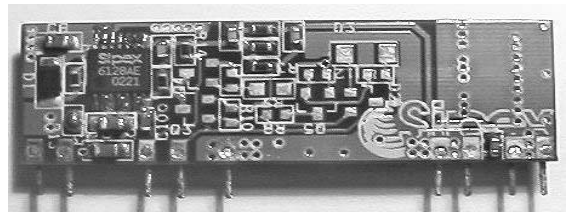
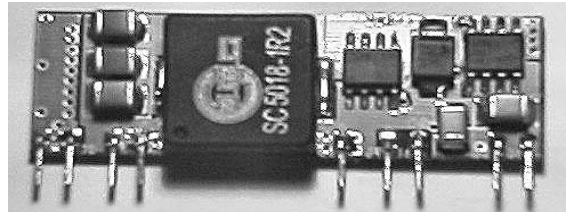

DESCRIPTION:

The SP6128A demo board design is non-isolated dc-dc SIP module with a very high efficiency at 10A output. It has smallest size comparing with the current market products with the same power range and low EMI. Standard features include remote ON/OFF with the customer selectable positive and negative control, output voltage adjustment, soft start, over current and over temperature protection. This demo board proves that SP6128A is a high performance, but yet easy to use synchronous buck controller. It simplifies low voltage DC to DC power supply designs without compromising performance.

APPLICATION

- workstations, servers
- computer and its peripheral
- distribution power architecture
- telecommunications equipment
- data processing and storage equipment
- LANs and WANs
- high performance data processing IC

SCHEMATIC:

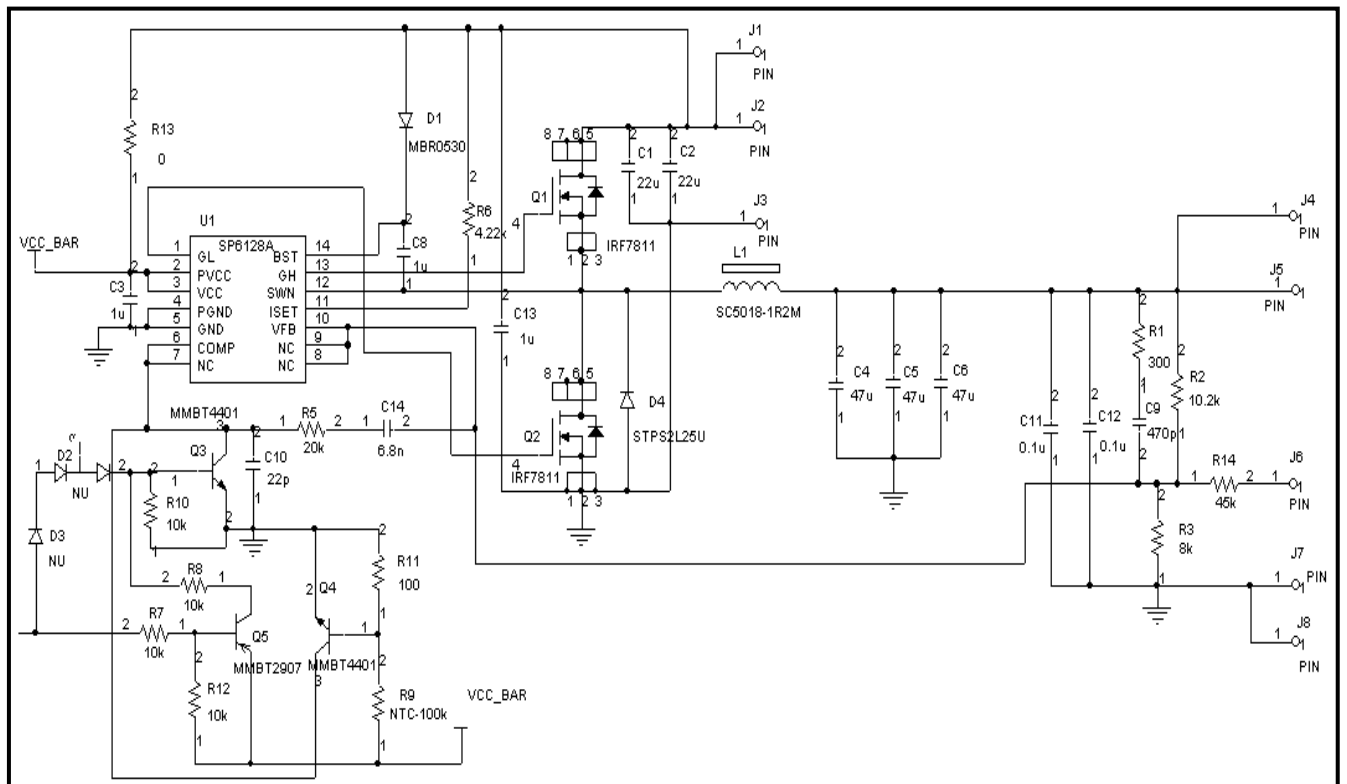

PCB Layout:

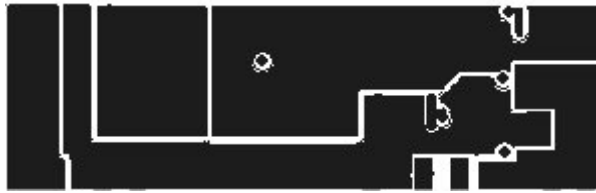

Top Layer



Internal-1 layer



Internal-2 layer



Bottom Layer

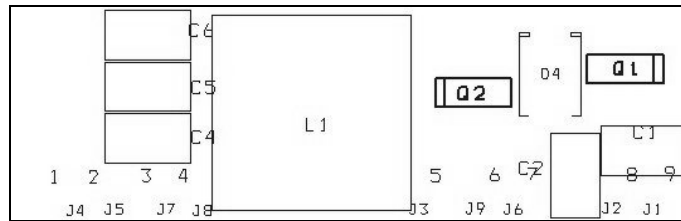

SST

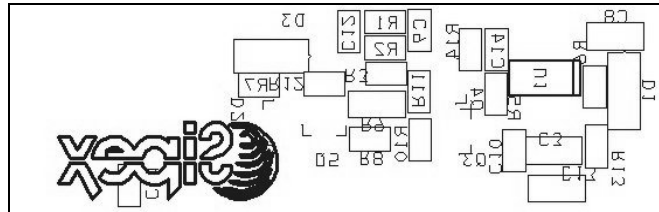

SSB

CHARACTERISTIC CURVE (1.8V output)

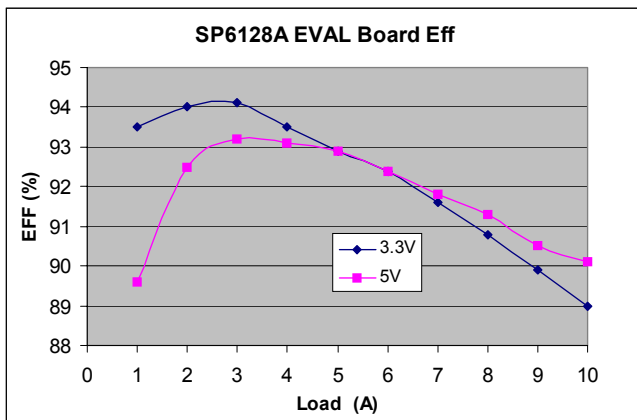

Figure 1

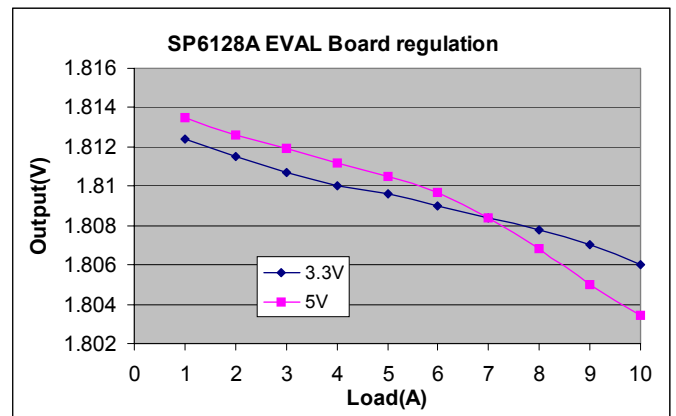

Figure 2

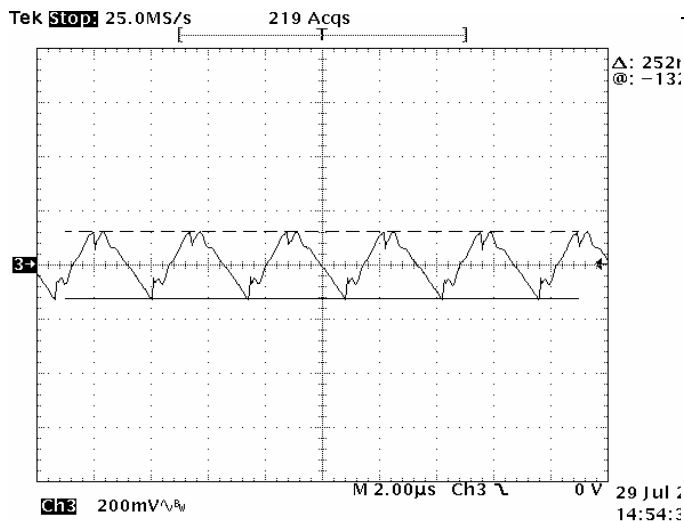

Figure 3: input ripple @ Vin=3.3V, Io=10A

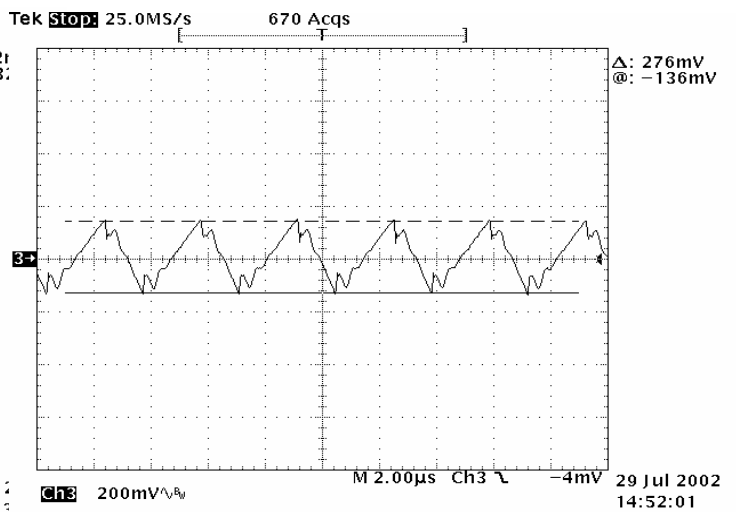

Figure 4: input ripple @ Vin=5V, Io=10A

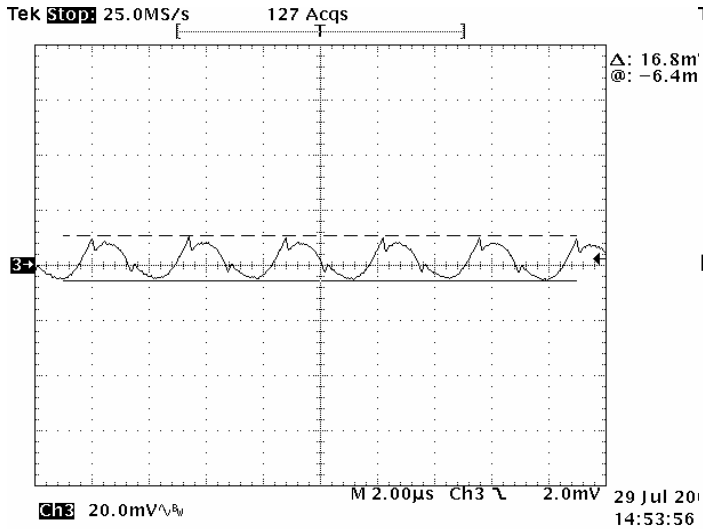

Figure 5:output ripple @ Vin=3.3V Io=10A

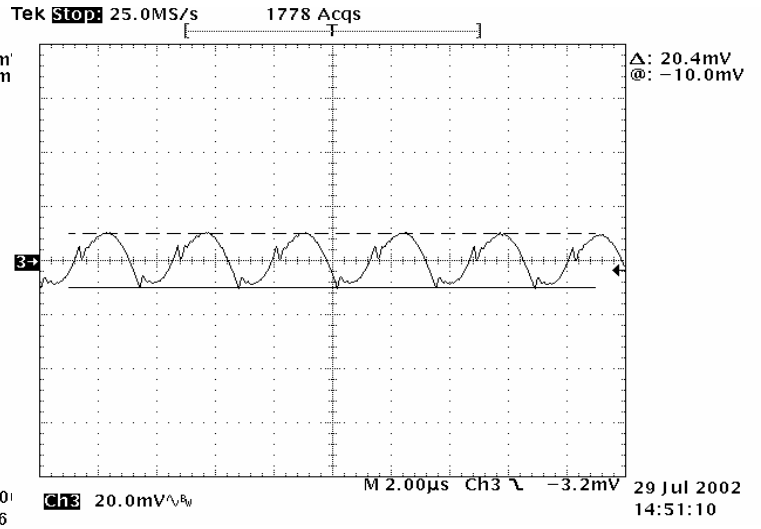

Figure 6:output ripple @ Vin=5V Io=10A

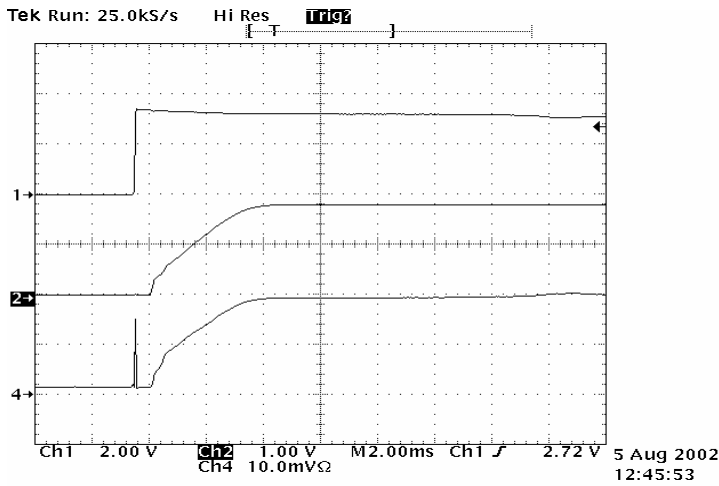

Figure 7: startup, Ch1:Vin, Ch2:Vout, Ch3:lin 2A/div @Io=10A

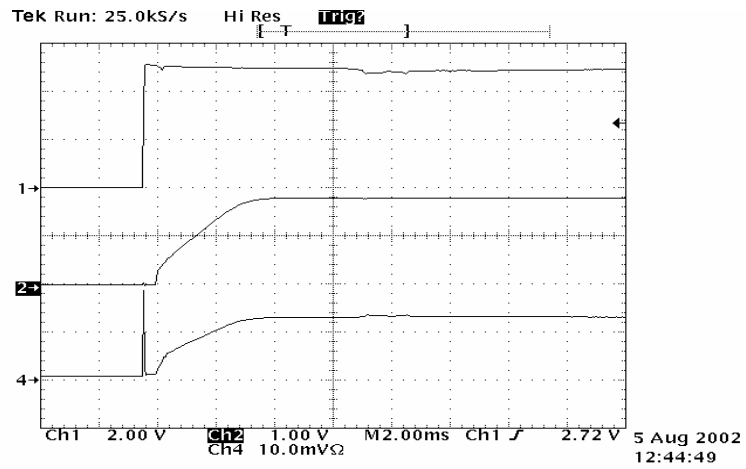

Figure 8 startup, Ch1:Vin, Ch2:Vout, Ch3:lin 2A/div @Io=10A

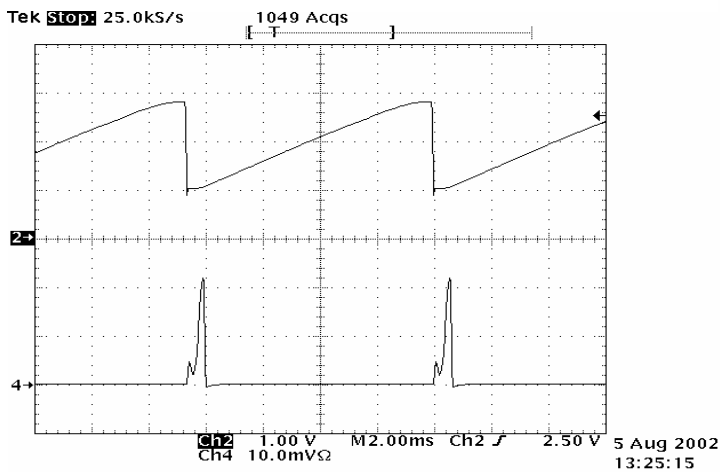

Figure 9: output short, Ch2: COM Ch4:lin 5A/div@Vin=3.0V

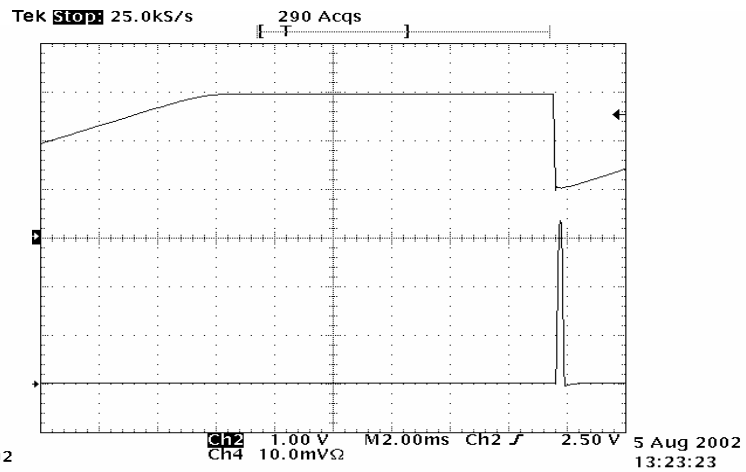

Figure 10: output short, Ch2: COM Ch4:lin 5A/div@Vin=5.0V

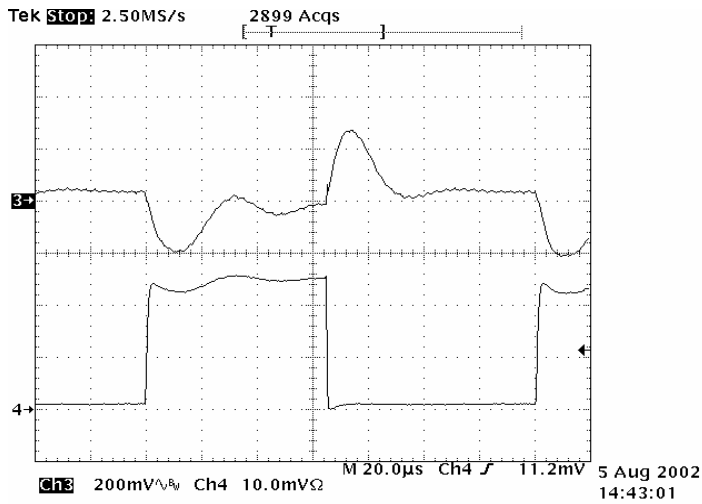

Figure11: transient response, Ch1:Vout
Ch2:Iout 2A/div load change
At 5A/us from 0.4A to 5A @
Vin=3.3V

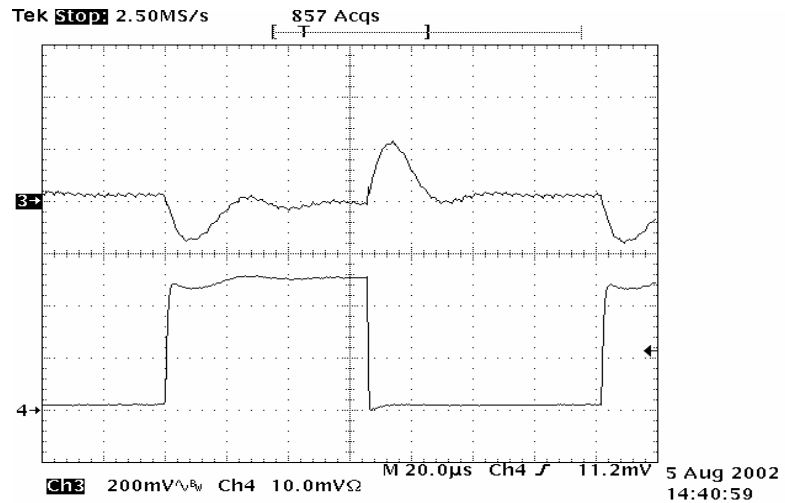

Figure12: transient response, Ch1:Vout
Ch2:Iout 2A/div load change
At 5A/us from 0.4A to 5A @
Vin=5V

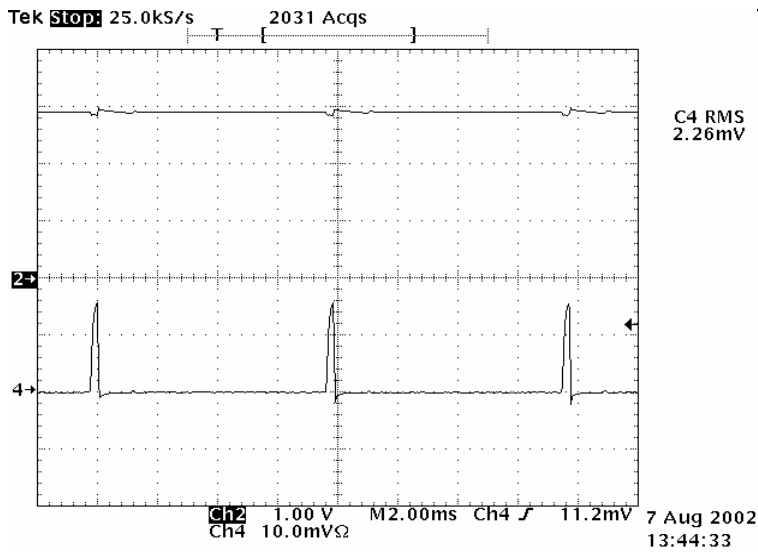

Figure13: short circuit lin RMS value
Ch2: Vin, Ch4 lin 2A/div

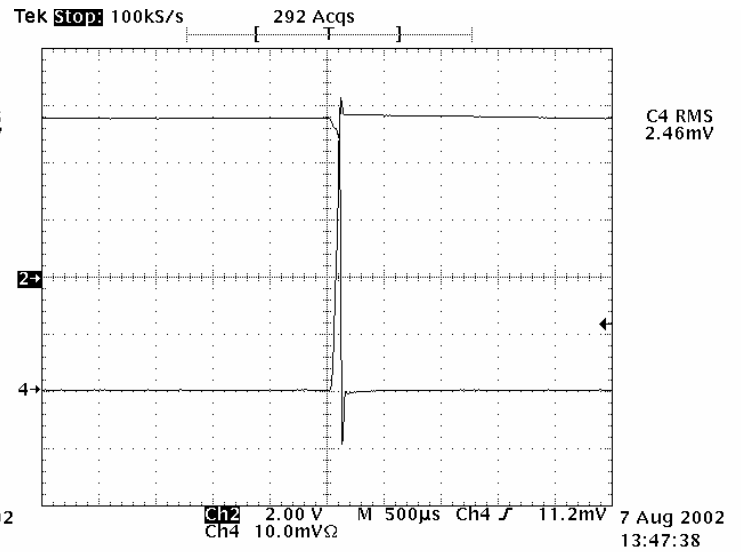

Figure14: short circuit lin RMS value
Ch2: Vin, Ch4 lin 2A/div

*short circuit protection tested at with Cin=100uF, Tantalum

ELECTRICAL SPECIFICATIONS

Parameter	Symbol	Min	Typ	Max	Units
Operating input voltage	Vin	2.9		6	Vdc
Input voltage ripple	Vinripple		250	300	mVp-p
Output voltage set point accurate				± 1.5	%
Output regulation					
Line regulation				± 0.1	%
Load regulation				± 0.3	%
Output ripple&noise			15	25	mVp-p
Output current	Io			10	A
Output current limit point				16	A
Over temperature protection			110	120	°C
Negative remote control:	Vrem	-0.7		0.3	V
Logic low-module on	Irem			100	μ A
Logic high-module off	Vrem			2.4	V
	Irem			0.5	mA
Positive remote control:	Vrem	2.4			V
Logic high-module on	Irem			1	mA
Logic low-module off	Vrem	-0.7		0.8	V
	Irem			1	μ A
Turn-on time				5	ms
Short circuit input current(RMS)				0.5	A
Output voltage trim range		-10		+10	% Vout ,nom

FEATURE DISCRIPTION

Output voltage trim function:

In this design, there is a trim pin that allows the customer to trim the output voltage to ± 10% off the nominal voltage.

In the schematic on page 2, R3, R14, R2 and external trim resistor (Rtrim) comprise the trim function circuit. To trim-up, connect Rtrim between trim pin and GND. The Rtrim value is equal to:

$$R_{trim} = \frac{0.8 \times R_2}{\Delta V} - R_{14}$$

To trim-down, connect Rtrim between trim pin and Vout. The Rtrim value can be derived from:

$$R_{trim} = \frac{0.8 \times R_2^2}{R_3 \times \Delta V} - R_2 - R_{14}$$

Remote On/OFF:

This design allows user to select positive or negative logic remote control. This demo board only implements the negative logic remote control circuit. To change to positive logic, remove Q5, R7, R8, and R12. and add D2 and D3.

Over temperature protection:

The over temperature protection will shut down the module when abnormal high temperature is detected by the circuit.. The module will attempt to restart once the temperature cools down. The temperature set point can be adjusted by resistor R11.

Mechanical Outline Diagram

Dimensions are in millimeter (inch)

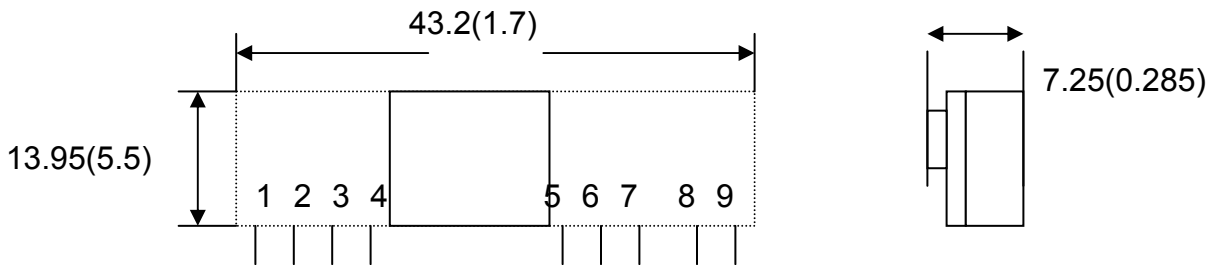

IN	FUNCTION
1	Vo
2	Vo
3	GND
4	GND
5	GND
6	ON/OFF
7	Trim
8	Vi
9	Vi

*the pin out is not the same as standard

BILL MATERIAL

Item	Quantity	Reference	Part	Manufacture information
1	2	C1,C2	22u	TDK C3225X5R1A226M
2	3	C3,C8,C13	1u	TDK C2012X7R1C105K
3	3	C4,C5,C6	47u	TDK C3225X5R0J476M
4	1	C9	470p	TDK C1608C0G1H471J
5	1	C10	22p	TDK C1608C0G1H220J
6	2	C11,C12	0.1u	TDK C1608X7R1H104K
7	1	C14	6.8n	TDK C1608X7R1H682K
8	1	D1	MBR0530	ON semiconductor
10	1	D4	STPS2L25U	ST
11	9	J1,J2,J3,J4,J5,J6,J7,J8,J9	PIN	
12	1	L1	SC5018-1R2M	Easy Magnetic
13	2	Q1,Q2	IRF7811W	IRF
14	1	R1	300	0603
15	1	R2	10.2k	0603
16	1	R3	8k	0603
17	1	R5	20k	0603
18	1	R6	4.22k	0603
19	1	R13	0	0603
20	1	R14	45k	0603
21	1	U1	SP6128A	SIPEX
22	1	R11	100	0603
23	4	R7,R8,R10,R12	10K	0603
24	2	Q3,Q4	MMBT4401	ON semiconductor
25	1	Q5	MMBT2907	ON semiconductor
22	1	R9	NTC-100K	TDK NTCG204CH104J

* For the low profile application, SC5015-1R2M from Easy magnetic recommended for L1

EFFICIENCY ON THE DIFFERENT OUTPUT VOLTAGE

Input voltage	Output voltage	Output current	Efficiency	Internal Trim resistor
3.0-5.5V	0.9V	10A	82%	80.6K
3.0-5.5V	1V	10A	84%	40.2K
3.0-5.5V	1.2V	10A	86%	20.5K
3.0-5.5V	1.5V	10A	88%	11.8K
3.0-5.5V	1.8V	10A	90.5%	8.06K
3.0-5.5V	2.0V	10A	90.5%	6.81K
3.0-5.5V	2.5V	10A	92.7%	4.75K
4.5-5.5V	3.3V	10A	94.5%	3.24K



SIGNAL PROCESSING EXCELLENCE

Headquarters and sales office

22 Linnell Circle
Billerica, MA 01821
TEL: 978-667-8700
FAX: 978-670-9001
E-mail: sales@sipex.com

Sales office

233 South Hillview Drive
Milpitas, CA 95035
TEL: 408-934-7500
FAX: 408-935-7600

Application support

Jack Ni
TEL: 978-671-4644
Email: jni@sipex.com
